

- 1
- 2
- 3
- 4
- 5
- 6
- 7
- 8
- 9
- 10
- 11
- 12
- 13
- 14
- 15



ÚCHYTKY, VĚŠÁKY A PROFILY



7.1	Kovové úchytky	310
7.2	Rustikální úchytky	329
7.3	Knopky	336
7.4	Dřevěné úchytky	342
7.5	Kožené a jiné úchytky	343
7.6	Zápustné úchytky	344
7.7	Věšáky	347
7.8	Dětské a plastové úchytky, knopky a věšáky	354
7.9.	Profilové úchytky	357
	Profilové úchytky - metráž	361
7.10	Profily pro bezúchytkové otevírání	363
	AKTUALIZACE SORTIMENTU 2022	366

Chemie

Kování pro
dveře

Stavební
kování

Kancelářské
vybavení

Světla

Technické
komponenty

Kování pod
nábytek

Drátěný
program

Úchytky

Dřezy,
baterie

Šatna

Posuvné
systémy

Výklopy,
rámcečky

Výsuvy

Závěsy

Kovové úchytky

	ALBA 310		ALESSANDRA 310		ANDREW 310		ANGELA 310
	ANZIO 310		BALDONE 311		BALMO 311		BÁRA 311
	BASILIA 311		BELLUNO 311		BERITA 311		BERTINA 312
	BETA 312		BONA 312		BRIGITA 312		
	CORIA 313		CRISTINA 313		DALIA 313		DARA 313
	DARIA 314		DENY 314		DINIA 314		DORA 314
	ELSA 314		FERIA 314		GABRIELLA 315		GENOA 315
	HRAZDA 10/12 315		CHALCIS 316		IDA 316		INTRA 316
	ISANA 316		JOVANA 316		JULI 316		KAIRA 317

PŘEHLED ÚCHYTEK A VĚŠÁKŮ

7 ÚCHYTKY, VĚŠÁKY A PROFILY



KRIS 317



LARA 317



LAURA 317



LEILA 318



LENNY 318



LESA 318



LIA 318



LIBRA 318



LILA 319



LINE 319



LORENZA 319



LORI 319



MANUELA 319



MARIA 319



MARINA 320



MEDILA 320



MIA 320



MILY 320



MONICA 320



NEIVA 321



NICOLE 321



NINA 321



NOEMI 321



PABLOS 322



PAOLA 322



PARMA 322



PORTOS 322



RADOS 323



RAVENA 323



REBEKA 323



RIALTO 323



RIVERA 323



ROLA 323



ROVIGO 324



SALONA 324



SAM 324

■ dodání do 24 hodin
 ■ dodání do 5 dní
 ■ na objednávku / na dotaz

PŘEHLED ÚCHYTEK A VĚŠÁKŮ

7 ÚCHYTKY, VĚŠÁKY A PROFILY



SAMARA 324



SANTA 325



SÁRA 325



SÁVA 325



SEBI 325



SERENA 325



SIERA 326



SIMA 326



STABIA 326



TALA 326



TALARA 326



TORNEA 327



UGO 327



VALEDA 327



VANTANIA 327



VERONICA 327



VIANA 328



VIOLETA 328

Rustikální úchytky



ADINA 329



AGLIA 329



ALBERTA 329



ALIDA 329



AMELIA 329



ARDENIA 330



ARLETA 330



CORDUBA 330



CUBATA 330



DIVERA 330



EGARA 330



GRETA 331



HAIDA 331



LAVIDA 331



MADALEN 331



MARILIN 331

PŘEHLED ÚCHYTEK A VĚŠÁKŮ

7 ÚCHYTKY, VĚŠÁKY A PROFILY

	MORANDA	332		NATÁLIA	332		OLVIA	332		OSIMO	332
	RIANA	332		RITA	333		ROSA	333		SALACIA	333
	SIENA	333		SOTERA	333		SPARTA	334		VERONA	334
	VESNA	334		VIENA	334		VILANA	335		VIRALA	335
	WITARA	335		ZAIRA	335						

Knopky

	ADINA	336		AGA	336		AGLIA	336		ALMUS	336
	ANGELA	336		BLOCK	337		CARLA	337		CATARINA	337
	CLEO GRANDE	337		CLEO PICCOLO	337		ELLIEN	337		GAIA	337
	HOLLY	338		INESA	338		JACOB	338		KELLI	338

■ dodání do 24 hodin
 ■ dodání do 5 dní
 ■ na objednávku / na dotaz

PŘEHLED ÚCHYTEK A VĚŠÁKŮ

7 ÚCHYTKY, VĚŠÁKY A PROFILY

1		LAURA	338		LAVIDA	338		LENNY	339		LIBRA	339
2		LIMA	339		MARILIN	339		MESSANA	339		NOEMI	339
3		OLIVIA	340		OLVIA	340		ORA	340		SÁVA	340
4		QUADROS	340		SERENA	340		SIMON	341		SPARTA	341
5		TOSCA	341		VESNA	341		VIANA	341		VILANA	341
6		ZAIRA	341									

Dřevěné úchytky

7		ARVIKA	342		DRIVA	342		HALŠA	342		MUŠLE	342
8		VALERIO	342									

Kožené a jiné úchytky



DALAS

343

SANTIAGO

343

TEXAS

343

Zápustné úchytky

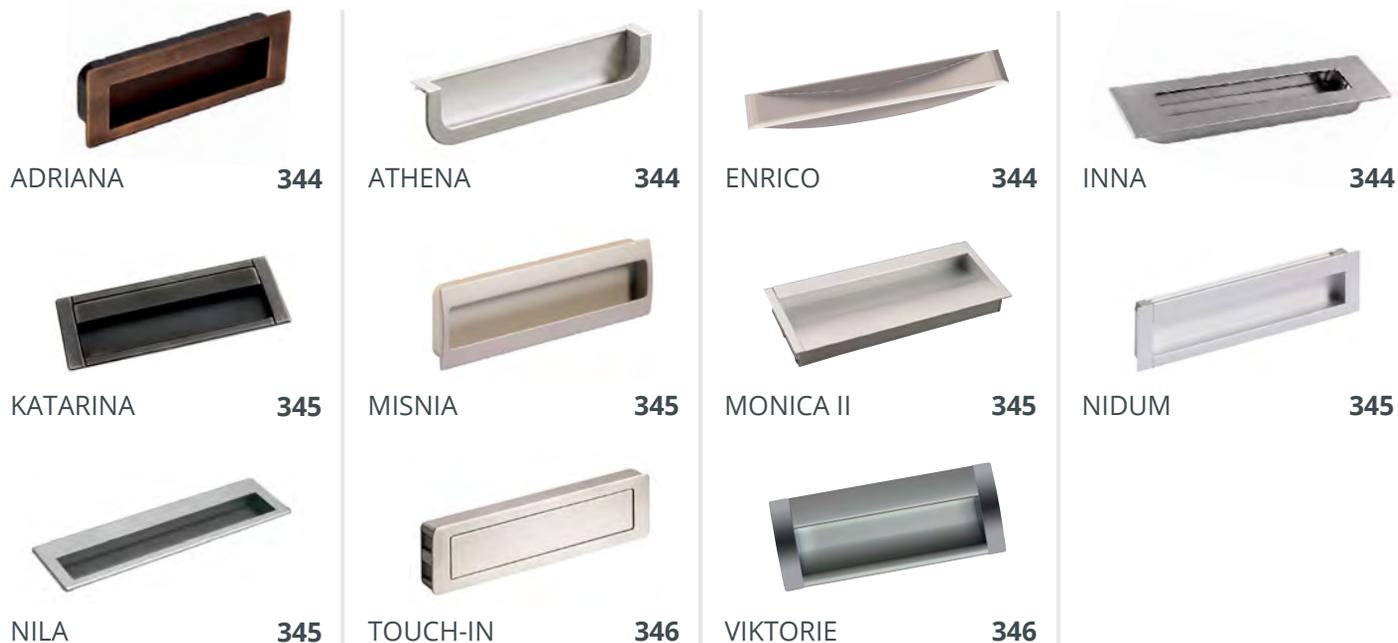

ADRIANA

344

ATHENA

344

ENRICO

344

INNA

344

KATARINA

345

MISNIA

345

MONICA II

345

NIDUM

345

NILA

345

TOUCH-IN

346

VIKTORIE

346

Věšáky



ALTIS/NAVY

347

AYA

347

ANTONIO

347

CORA

347

DAVID

347

DAVIDEK

347

DENVER

348

FABIO

348

FLINT

348

ISIS

349

KANSAS

349

KITTY

349

LIA

349

LIBRA

350

LINA

350

LOUISIANA

350

PŘEHLED ÚCHYTEK A VĚŠÁKŮ

7 ÚCHYTKY, VĚŠÁKY A PROFILY

	MARCO	351		MOLY	351		NIA	351		PAOLO	351
	PEDRO	352		PIETRO	352		POLO	352		SONNY	352
	TOLEDO	353		TOMAS	353		VIANA	353			

Dětské a plastové úchytky

	BELA	354		BERRY	354		BIBI	354		BRITA	354
	DIGI	354		HVĚZDIČKA	355		JOLY	355		JOY	355
	KNOFLÍK	355		KOČKA	355		KYTIČKA	355		MEDVÍDEK	355
	NOSOROŽEC	356		PIGI	356		PUMBA	356		PUPA	356
	RELY	356		SLON	356		VERA	356		BOLTA	355

Profilové úchytky

	LAMEZIA	357		SIMIA	357		THEA	357		UK 2	358
	UK 4	358		UK 5	358		UK 6	359		UK 7	359
	UK 8	359		UK 8 N	360		UK 9	360		UK 10	360
	UK 11	361									

KOVOVÉ ÚCHYTKY

ALBA

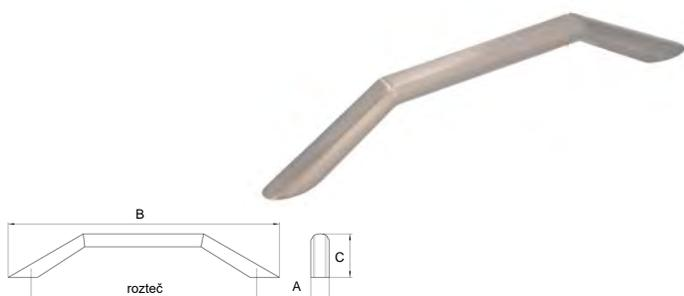

BAREVNÉ PROVEDENÍ	ROZTEČ	B	A	C	KÓD
chrom lesklý	128	154	11	25	802074
nikl jemně broušený	128	154	11	25	802076
staromosaz	128	154	11	25	802075

ALESSANDRA

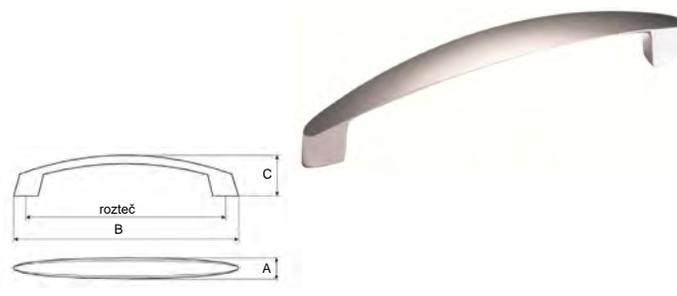

BAREVNÉ PROVEDENÍ	ROZTEČ	B	A	C	KÓD
chrom satén	128	184	17	25	011455
nikl satén	128	184	17	25	011582
nikl broušený	128	184	17	25	063604

ANDREW

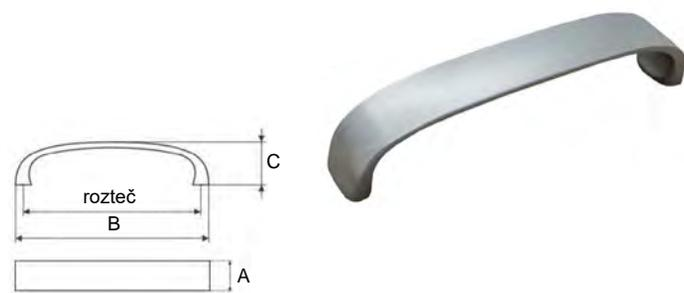

BAREVNÉ PROVEDENÍ	ROZTEČ	B	A	C	KÓD
chrom satén	96	105	12	22	063612
	128	137	12	25	063617
nikl satén	96	105	12	22	011458
	128	137	12	25	011832

ANGELA



NÁŠ TIP

Úchytka ANGELA můžete použít spolu s knopkami ANGELA.

BAREVNÉ PROVEDENÍ	ROZTEČ	B	A	C	KÓD
chrom lesklý	96	115	13	25	365338
chrom satén	96	115	13	25	365340
nikl satén	96	115	13	25	365339

ANZIO

PRODUKT	BAREVNÉ PROVEDENÍ	ROZTEČ	B	A	C	KÓD
ANZIO 10	nerez kartáčovaná	96	106	10	32	664643
		128	138	10	32	351141
		160	170	10	32	351185
		192	202	10	32	664644
		224	234	10	32	351227
		288	298	10	32	351274
		320	330	10	32	664646
		352	362	10	32	351304
		480	490	10	32	351363
		608	618	10	32	351557
ANZIO 12	nerez kartáčovaná	736	746	10	32	351607
		160	172	12	32	665113
		192	204	12	32	665115
		320	332	12	32	665114
		416	428	12	32	665117
		512	524	12	32	665118
		736	748	12	32	665119
		832	844	12	32	665120

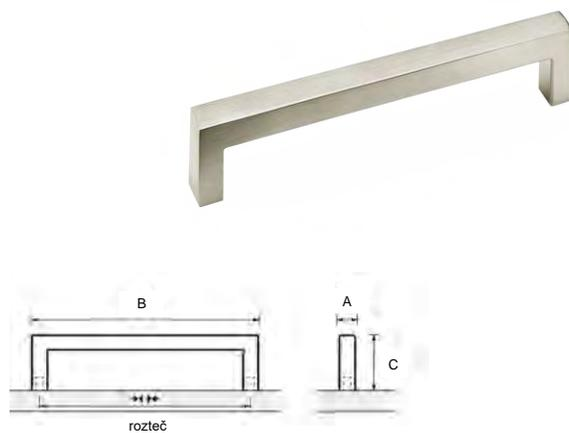

BERITA, chrom lesklý/bílá



BALDONE, nerez finiš

7.1 KOVOVÉ ÚCHYTKY

7 ÚCHYTKY, VĚŠÁKY A PROFILY

BALDONE

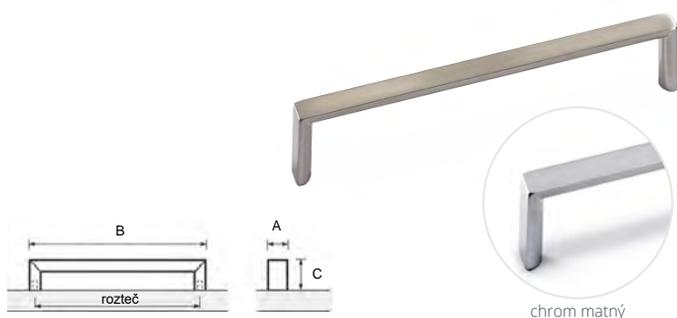

BAREVNÉ PROVEDENÍ	ROZTEČ	B	A	C	KÓD
chrom matný	96	104	11	26	350962
	128	136	11	26	350986
	160	168	11	26	351032
	256	264	15	29	351233
nerez finiš	96	102	12	26	350995
	128	134	12	26	351016
	160	166	12	26	351056
	256	262	15	29	351269

BALMO

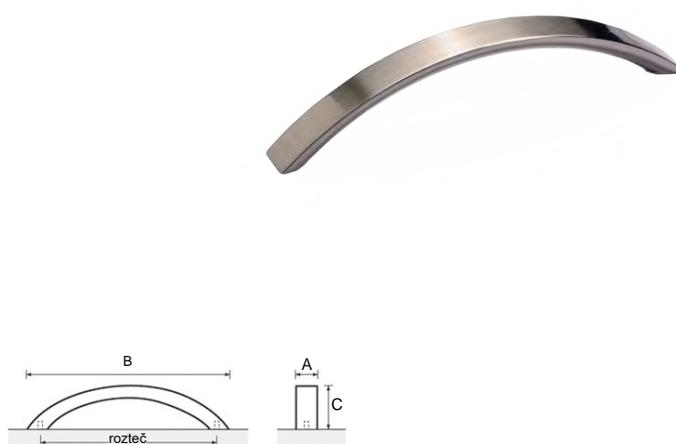

BAREVNÉ PROVEDENÍ	ROZTEČ	B	A	C	KÓD
chrom satén	128	149	15	32	062518
nerez	128	149	15	32	071527

BÁRA

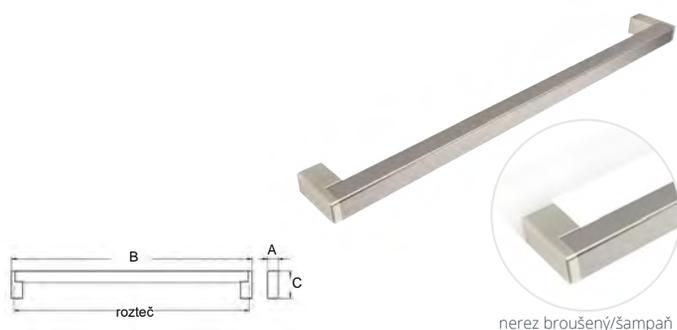

BAREVNÉ PROVEDENÍ	ROZTEČ	B	A	C	KÓD
nerez broušený/ chrom lesklý	128	138	14,5	35	581240
	160	170	14,5	35	581241
	256	266	14,5	35	581242
	320	330	14,5	35	581243
nerez broušený/ šampaň	128	138	14,5	35	581235
	160	170	14,5	35	581236
	256	266	14,5	35	581237
	320	330	14,5	35	581238

BASILIA

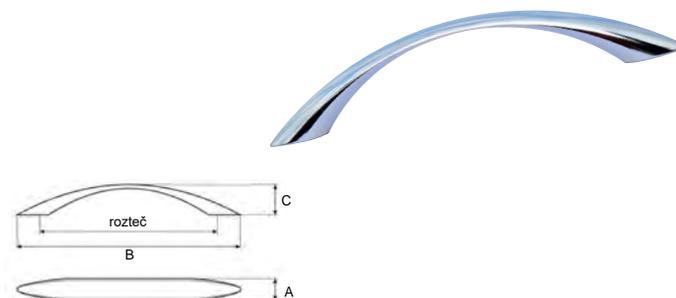

BAREVNÉ PROVEDENÍ	ROZTEČ	B	A	C	KÓD
černá	96	127	12	24	762449
	128	164	12	25	762783
chrom lesklý	96	127	12	24	078123
	128	164	12	25	034463
chrom satén	96	127	12	24	011439
	128	164	12	25	021504
nikl satén	96	127	12	24	011518
	128	164	12	25	011519

BELLUNO

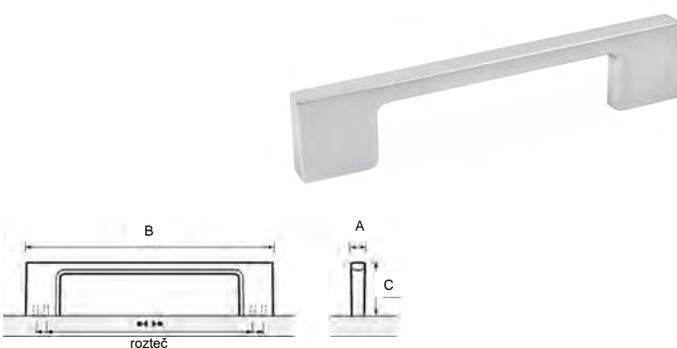

BAREVNÉ PROVEDENÍ	ROZTEČ	B	A	C	KÓD
chrom matný	96	130	9	28	696405
	160/192	200	9	30	696408
	224/256	267	9	30	040317
nerez finiš	96	130	9	28	351061
	160/192	200	9	30	351142
	224/256	267	9	30	351194

BERITA

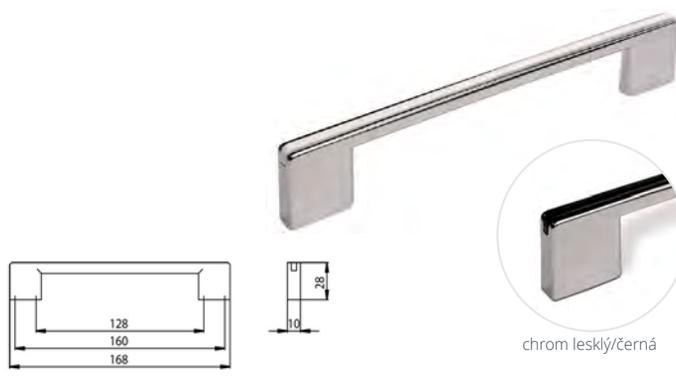

BAREVNÉ PROVEDENÍ	ROZTEČ	B	A	C	KÓD
chrom lesklý/bílá	128/160	168	10	28	687520
	128/160	168	10	28	644302
nikl jemně broušený/ bílá	128/160	168	10	28	689517
nikl jemně broušený/ černá	128/160	168	10	28	689520

7.1 KOVOVÉ ÚCHYTKY

7 ÚCHYTKY, VĚŠÁKY A PROFILY

BERTINA

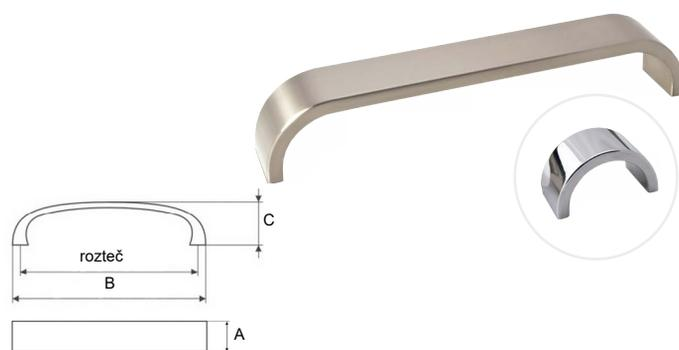

BAREVNÉ PROVEDENÍ	ROZTEČ	B	A	C	KÓD
chrom lesklý	64	72	35	40	298361
	224	232	35	40	289152
nikl jemně broušený	64	72	35	40	309665
	224	232	35	40	293267

BETA

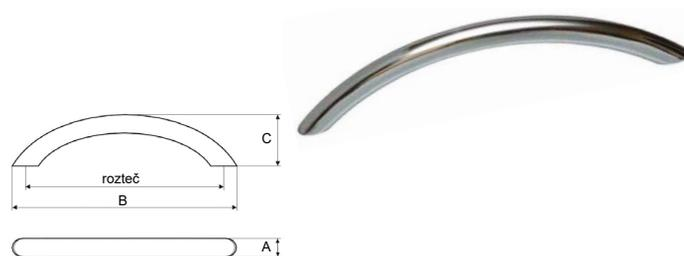

BAREVNÉ PROVEDENÍ	ROZTEČ	B	A	C	KÓD
chrom lesklý	96	113	10	30	349279
	128	152	10	30	349280
chrom satén	96	113	10	30	349283
	128	152	10	30	349284
nikl broušený	96	113	10	30	349281
	128	152	10	30	349282
nikl satén	96	113	10	30	349285
	128	152	10	30	349286

BONA

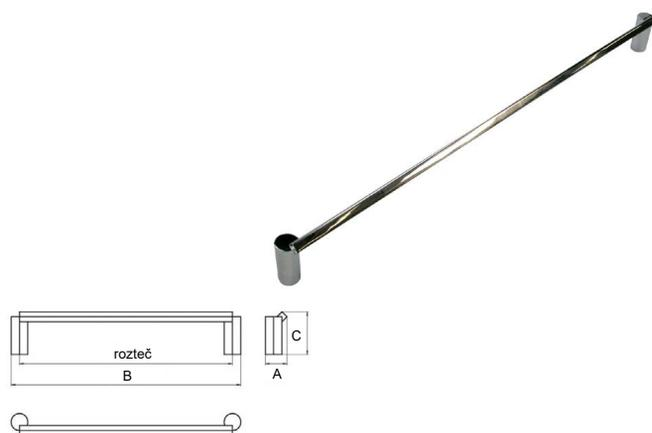

BAREVNÉ PROVEDENÍ	ROZTEČ	B	A	C	KÓD
chrom lesklý	320	332	16	31	802089

BRIGITA



BAREVNÉ PROVEDENÍ	ROZTEČ	B	A	C	KÓD
chrom lesklý	96	108	17	25	063606
chrom satén	96	108	17	25	063607
nikl satén	96	108	17	25	011456

7.1 KOVOVÉ ÚCHYTKY

7 ÚCHYTKY, VĚŠÁKY A PROFILY

CORIA

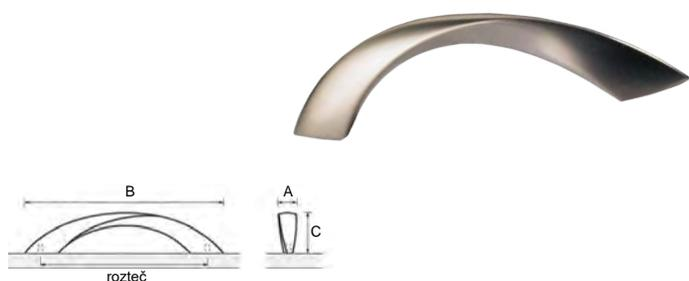

BAREVNÉ PROVEDENÍ	ROZTEČ	B	A	C	KÓD
chrom lesklý	128	151	16	34	714295
chrom matný	128	151	16	34	351151
nerezový vzhled	128	151	16	34	344713
nikl matný	128	151	16	34	351150

CRISTINA

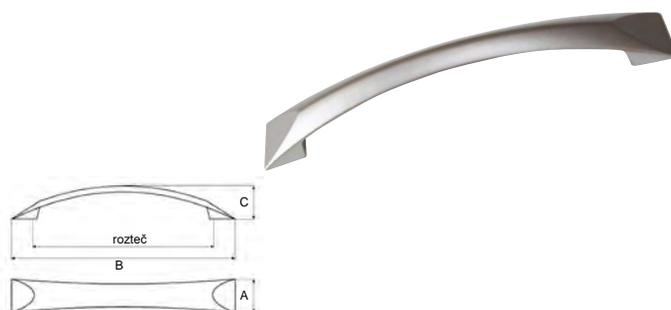

BAREVNÉ PROVEDENÍ	ROZTEČ	B	A	C	KÓD
chrom satén	128	156	23	23	185738
nikl broušený	128	156	23	23	365350
nikl satén	128	156	23	23	145966

DALIA

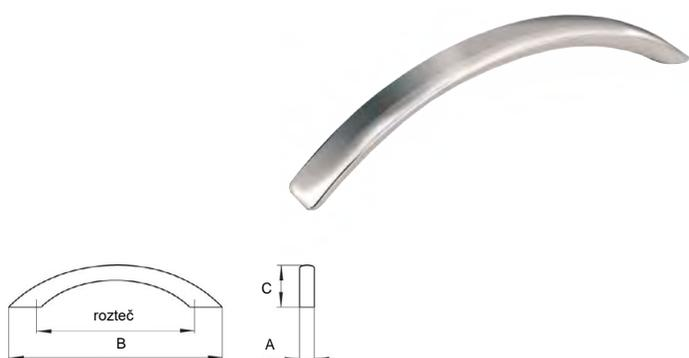

BAREVNÉ PROVEDENÍ	ROZTEČ	B	A	C	KÓD
chrom lesklý	128	146	15	30	047387
chrom matný	128	146	15	30	011655
nikl jemně broušený	128	146	15	30	038940
nikl matný	128	146	15	30	054981



DARA

BAREVNÉ PROVEDENÍ	ROZTEČ	B	A	C	KÓD
ALU efekt	96	104	9	28	540853
	128	136	9	28	532591
	160	168	9	28	528447
	192	200	9	28	546442
	224	232	9	28	676459
černá mat	320	328	9	28	626087
	96	104	9	28	768239
	128	136	9	28	787866
	160	168	9	28	768241
	192	200	9	28	755694
chrom lesklý	224	232	9	28	208491
	320	328	9	28	787868
	96	104	9	28	522345
	128	136	9	28	571472
	160	168	9	28	528473
měď broušená	192	200	9	28	522340
	224	232	9	28	522341
	320	328	9	28	524730
	160	168	9	28	802098
	224	232	9	28	802099
nikl jemně broušený	96	104	9	28	533192
	128	136	9	28	628489
	160	168	9	28	571660
	192	200	9	28	522342
	224	232	9	28	571659
železo černá patina	320	328	9	28	516002
	128	136	9	28	787867
	160	168	9	28	738607
	320	328	9	28	787869

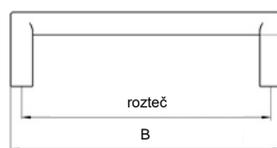

7.1 KOVOVÉ ÚCHYTKY

7 ÚCHYTKY, VĚŠÁKY A PROFILY

DARIA

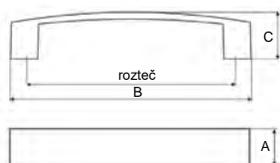

BAREVNÉ PROVEDENÍ	ROZTEČ	B	A	C	KÓD
hliník	128	146	25	28	063677

DENY

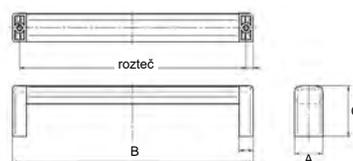

BAREVNÉ PROVEDENÍ	ROZTEČ	B	A	C	KÓD
nerez broušený	160	170	20	35	581307
	320	330	20	35	581308
nerez/antracit	160	170	20	35	581309
	320	330	20	35	581310

DINIA

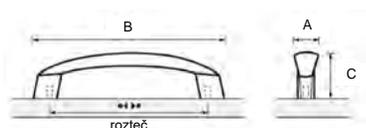

BAREVNÉ PROVEDENÍ	ROZTEČ	B	A	C	KÓD
chrom satén	96	118	16	28	029806
	128	143	18	29	029838
nerez finiš	96	118	16	28	029805
	128	143	18	29	029872

DORA

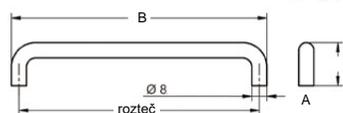

BAREVNÉ PROVEDENÍ	ROZTEČ	B	A	C	KÓD
chrom lesklý	128	136	8	30	581179
	256	264	8	30	581181
	320	264	8	28	581182

ELSA

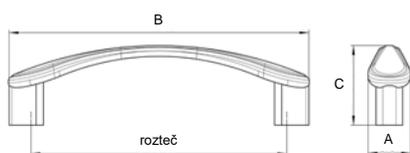

BAREVNÉ PROVEDENÍ	ROZTEČ	B	A	C	KÓD
ALU efekt	96	113	16	28,5	030302
	128	150	16	29,5	029395
chrom lesklý	96	113	16	28,5	802086
	128	150	16	29,5	802087
nikl jemně broušený	96	113	16	28,5	047409
	128	150	16	29,5	104006
nikl matný	96	113	16	28,5	047408
	128	150	16	29,5	032074

FERIA

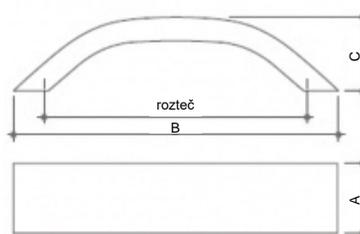

BAREVNÉ PROVEDENÍ	ROZTEČ	B	A	C	KÓD
černá mat	96	116	25	26,5	790124
	128	146	25	26,5	790125
	160	180	25	26,5	790126
	192	212	25	26,5	761654
	224	244	25	26,5	790127
	256	275	25	26,5	790128
	320	340	25	26,5	790129

7.1 KOVOVÉ ÚCHYTKY

7 ÚCHYTKY, VĚŠÁKY A PROFILY

GABRIELLA

GENOA

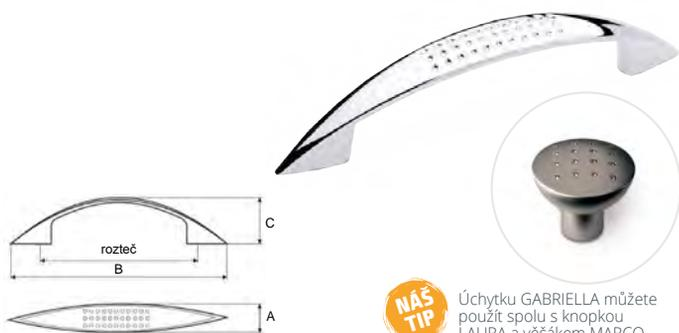

NÁŠ TIP

Úchytka GABRIELLA můžete použít spolu s knopkou LAURA a věšákem MARCO.

BAREVNÉ PROVEDENÍ	ROZTEČ	B	A	C	KÓD
chrom lesklý	96	132	15	28	063627
	128	164	15	28	042639
chrom satén	96	132	15	28	011460
	128	164	15	28	063628
nikl satén	96	132	15	28	043673
	128	164	15	28	035553

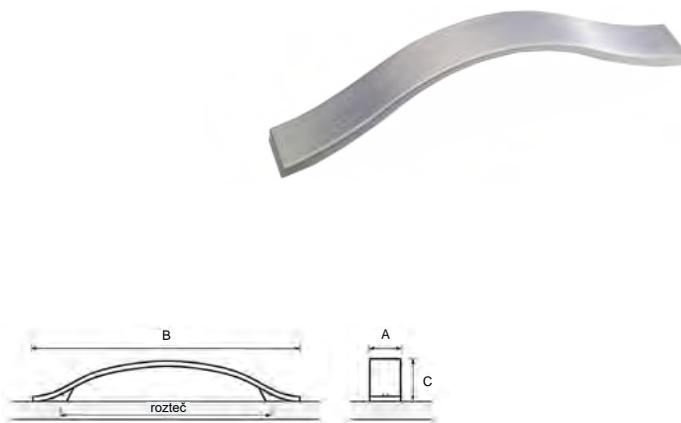

BAREVNÉ PROVEDENÍ	ROZTEČ	B	A	C	KÓD
chrom lesklý	128	170	23	26	160772
nerez finiš	128	170	23	26	160796

HRAZDA 10/12

PRODUKT	BAREVNÉ PROVEDENÍ	ROZTEČ	B	A	C	KÓD	
HRAZDA 10	chrom lesklý	96	156	10	32	518853	
		128	188	10	32	518854	
	chrom satén	160	220	10	32	518855	
		96	156	10	32	518850	
	nikl broušený	128	188	10	32	518851	
		96	156	10	32	518847	
	černá	chrom lesklý	128	188	10	32	518848
			96	156	12	31	763585
		chrom satén	128	188	12	31	763586
			160	220	12	31	762447
nikl broušený		192	272	12	31	763587	
		224	304	12	31	763589	
černá		320	400	12	31	763593	
		448	528	12	31	763595	
chrom lesklý		576	656	12	31	763596	
		96	156	12	31	473948	
HRAZDA 12	chrom lesklý	128	188	12	31	473949	
		160	220	12	31	473950	
	chrom satén	192	272	12	31	473951	
		224	304	12	31	473952	
	nikl broušený	320	400	12	31	473953	
		448	528	12	31	473954	
	chrom lesklý	640	720	12	31	696584	
		96	156	12	31	471837	
	chrom satén	128	188	12	31	471839	
		160	220	12	31	471841	
nikl broušený	192	272	12	31	471843		
	224	304	12	31	471845		
chrom lesklý	320	400	12	31	471847		
	448	528	12	31	471849		
chrom satén	576	656	12	31	471851		
	640	720	12	31	471853		
nikl broušený	736	856	12	31	471855		
	800	920	12	31	471859		
chrom lesklý	96	156	12	31	473955		
	128	188	12	31	473956		
chrom satén	160	220	12	31	473957		
	192	272	12	31	473958		
nikl broušený	224	304	12	31	473959		
	320	400	12	31	473960		
chrom lesklý	416	496	12	31	581280		
	448	528	12	31	473961		
chrom satén	480	560	12	31	581282		
	576	656	12	31	473962		
nikl broušený	640	720	12	31	473963		
	736	856	12	31	473964		
chrom lesklý	800	920	12	31	473965		
	96	156	12	31	471838		
chrom satén	128	188	12	31	471840		
	160	220	12	31	471842		
nikl broušený	192	272	12	31	471844		
	224	304	12	31	471846		
chrom lesklý	320	400	12	31	471848		
	448	528	12	31	471850		
chrom satén	576	656	12	31	471852		
	640	720	12	31	471854		
nikl broušený	736	856	12	31	471857		
	800	920	12	31	471858		

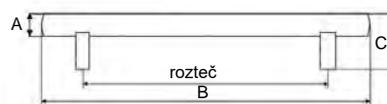

HRAZDA, nikl broušený

7.1 KOVOVÉ ÚCHYTKY 7 ÚCHYTKY, VĚŠÁKY A PROFILY

CHALCIS

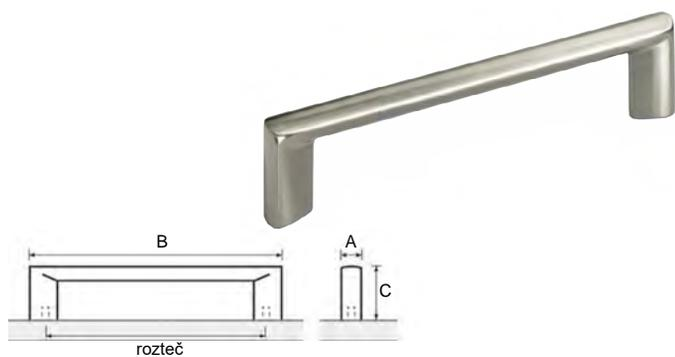

BAREVNÉ PROVEDENÍ	ROZTEČ	B	A	C	KÓD
imitace nerezí	128	147	11	31	351039
	288	301	11	31	351238

IDA

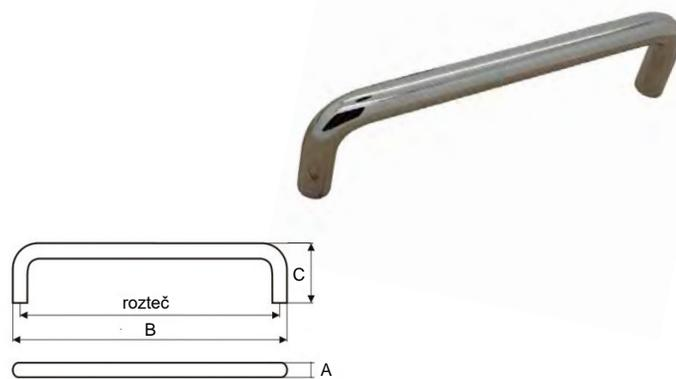

BAREVNÉ PROVEDENÍ	ROZTEČ	B	A	C	KÓD
chrom lesklý	96	104	8	30	349277
chrom satén	96	104	8	30	349278

INTRA



BAREVNÉ PROVEDENÍ	ROZTEČ	B	A	C	KÓD
bílá mat/měděná	192	204	25	26	665058
černá mat/nerez	192	204	25	26	665056
chrom lesklý/chrom satén	192	204	25	26	351235
chrom satén/chrom lesklý	192	204	25	26	317409
imitace nerezí/chrom lesklý	192	204	25	26	317410

ISANA

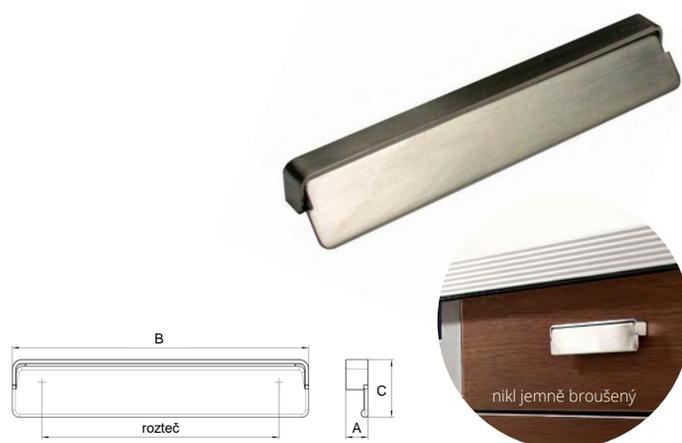

BAREVNÉ PROVEDENÍ	ROZTEČ	B	A	C	KÓD
nikl jemně broušený	128	160	12	30	802088

JOVANA

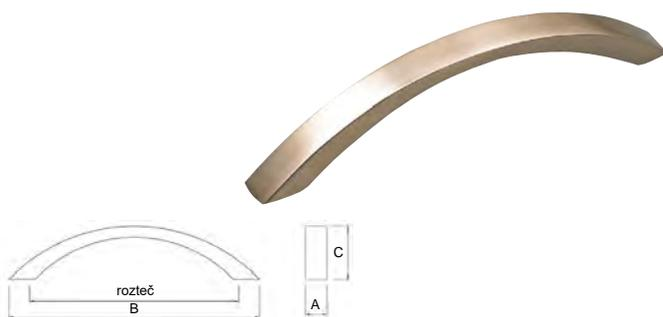

BAREVNÉ PROVEDENÍ	ROZTEČ	B	A	C	KÓD
chrom satén	128	150	10	27	344329
nikl broušený	128	150	10	27	344328

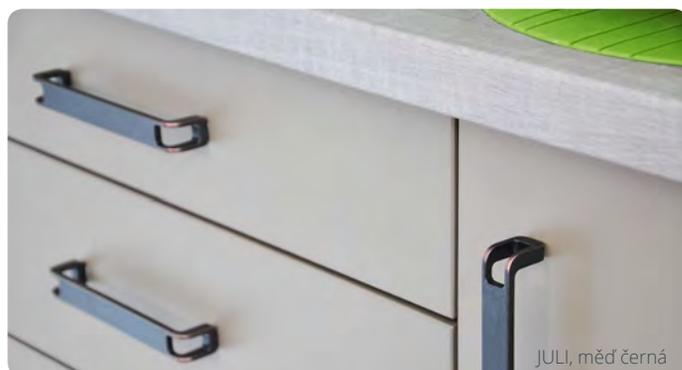

JULI

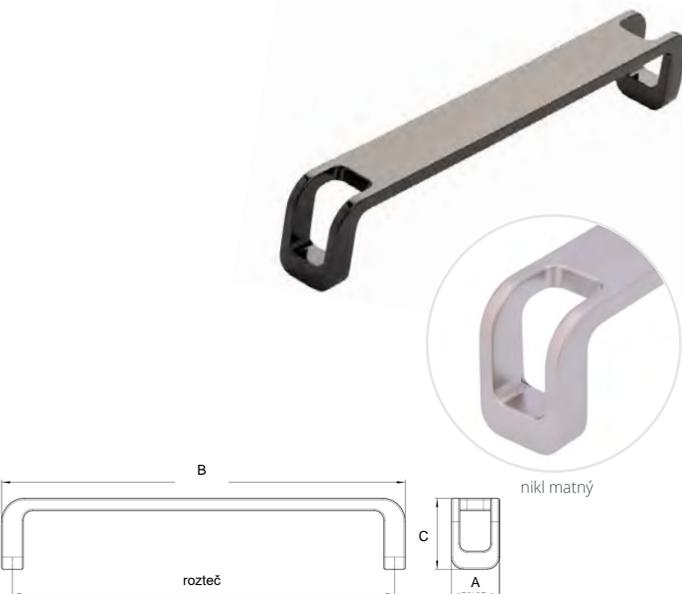

BAREVNÉ PROVEDENÍ	ROZTEČ	B	A	C	KÓD
antracit	160	169	20	29	802108
chrom lesklý	160	169	20	29	802109
měď černá	160	169	20	29	802112
nikl jemně broušený	160	169	20	29	802110
nikl matný	160	169	20	29	802111

7.1 KOVOVÉ ÚCHYTKY

7 ÚCHYTKY, VĚŠÁKY A PROFILY

KAIRA

BAREVNÉ PROVEDENÍ	ROZTEČ	B	A	C	KÓD
černá mat	64	94	16	20	787879
	160	190	16	20	787870
	320	350	16	20	787875
chrom lesklý	64	94	16	20	787880
	160	190	16	20	787871
	320	350	16	20	787876
nikl jemně broušený	64	94	16	20	787881
	160	190	16	20	787872
	320	350	16	20	787877
starozlatá	64	94	16	20	787882
	160	190	16	20	787873
	320	350	16	20	787878
železo broušené	64	94	16	20	787883
	160	190	16	20	787874

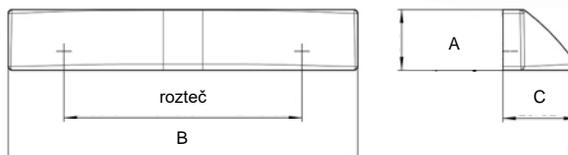

KAIRA, starozlatá

KRIS

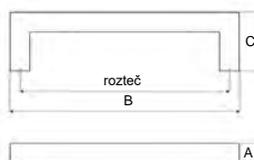

BAREVNÉ PROVEDENÍ	ROZTEČ	B	A	C	KÓD
nerez	160	180	12	22	512698
	320	340	12	22	512699

LARA



BAREVNÉ PROVEDENÍ	ROZTEČ	B	A	C	KÓD
antracit	160	168	12	30	802117
	320	328	12	30	802120
chrom lesklý	160	168	12	30	802116
	320	328	12	30	802119
nikl jemně broušený	160	168	12	30	802118
	320	328	12	30	802121

LAURA

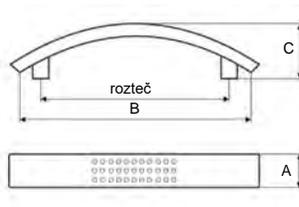

NAŠ TIP

Úchytka LAURA můžete použít spolu s knopkou LAURA a věšákem MARCO.

BAREVNÉ PROVEDENÍ	ROZTEČ	B	A	C	KÓD
chrom lesklý	96	124	17,5	27	037986
	128	156	17,5	27	056895
chrom satén	96	124	17,5	27	063622
	128	156	17,5	27	063624
nikl satén	96	124	17,5	27	011512
	128	156	17,5	27	063623

7.1 KOVOVÉ ÚCHYTKY 7 ÚCHYTKY, VĚŠÁKY A PROFILY

LEILA

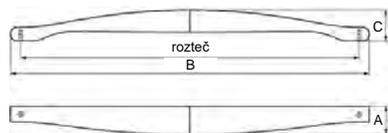

BAREVNÉ PROVEDENÍ	ROZTEČ	B	A	C	KÓD
antracit	160	185	18	23	751480
	320	339	18	24	751476
antracit mat	160	185	18	23	683359
	320	339	18	24	738532
chrom lesklý	160	185	18	23	698446
	320	339	18	24	681674
nikl jemně broušený	160	185	18	23	671386
	320	339	18	24	674187
ušlechtilá ocel efekt	160	185	18	23	674186
	320	339	18	24	693491

LENNY



NÁŠ TIP

Úchytka LENNY můžete použít spolu s knopkou LENNY.

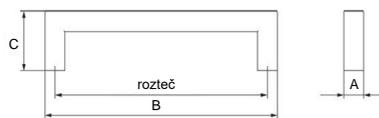

BAREVNÉ PROVEDENÍ	ROZTEČ	B	A	C	KÓD
nerez	96	108	12	35	695707
	128	140	12	35	702222
	160	172	12	35	696857
	320	332	12	35	680663

LESA

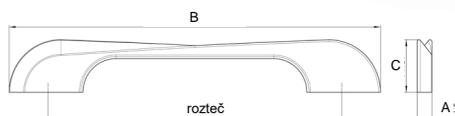

BAREVNÉ PROVEDENÍ	ROZTEČ	B	A	C	KÓD
chrom lesklý	160	203	8	28	802104
	224	267	8	28	802106
nikl jemně broušený	160	203	8	28	802105
	224	267	8	28	802107



LEILA, antracit

LIA

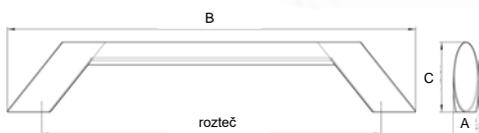

BAREVNÉ PROVEDENÍ	ROZTEČ	B	A	C	KÓD
antracit	160	192	12	33	802123
	320	352	12	33	802126
chrom lesklý	160	192	12	33	802122
	320	352	12	33	802125
nikl jemně broušený	160	192	12	33	802124
	320	352	12	33	802127

LIBRA

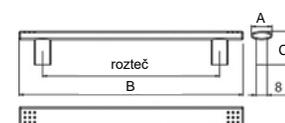

NÁŠ TIP

Úchytka LIBRA můžete použít spolu s knopkou a věšákem LIBRA.

BAREVNÉ PROVEDENÍ	ROZTEČ	B	A	C	KÓD
chrom matný	96	130	15	24	011432
	128	162	15	24	011708
nikl jemně broušený	96	130	15	24	011429
	128	162	15	24	039992
nikl matný	96	130	15	24	019943
	128	162	15	24	030934

7.1 KOVOVÉ ÚCHYTKY

7 ÚCHYTKY, VĚŠÁKY A PROFILY

LILA

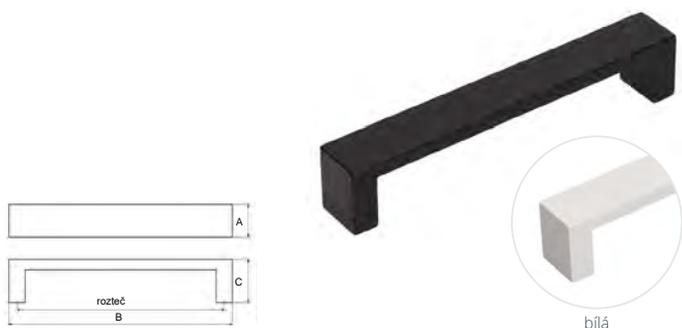

BAREVNÉ PŘÍKRYTÍ	ROZTEČ	B	A	C	KÓD
bílá	160	170	20	26	757689
	192	202	20	26	757690
	320	330	20	26	759762
černá	160	170	20	26	757687
	192	202	20	26	757688
	320	330	20	26	759763

LINE

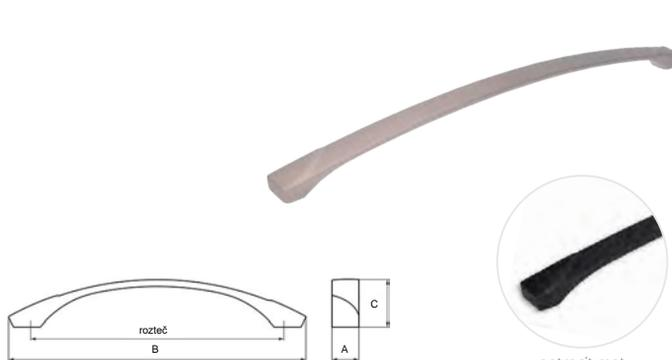

BAREVNÉ PŘÍKRYTÍ	ROZTEČ	B	A	C	KÓD
antracit mat	160	188	17	29	754617
	320	348	17	30	754615
ušlechtilá ocel matná	160	188	17	29	754616
	320	348	17	30	754614

LORENZA



BAREVNÉ PŘÍKRYTÍ	ROZTEČ	B	A	C	KÓD
chrom satén	128	134	20	28	410190
nikl broušený	128	134	20	28	662656
nikl satén	128	134	20	28	514624

LORI

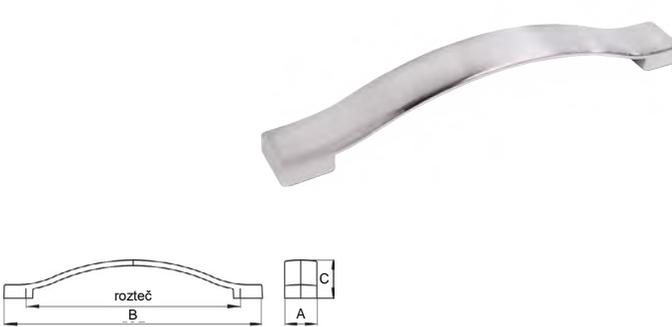

BAREVNÉ PŘÍKRYTÍ	ROZTEČ	B	A	C	KÓD
ALU efekt	160	193	24	28	118448
chrom lesklý	160	193	24	28	571475
nikl jemně broušený	160	193	24	28	117939

MANUELA

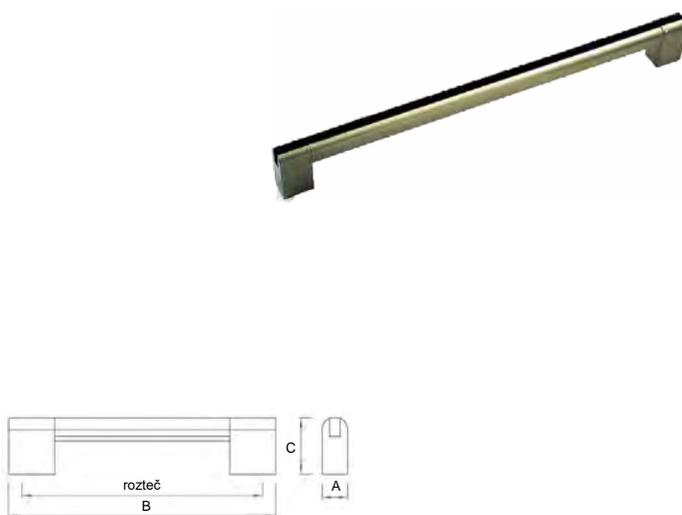

BAREVNÉ PŘÍKRYTÍ	ROZTEČ	B	A	C	KÓD
hliník/chrom satén	160	173	17	37	344316
	224	237	17	37	344318
	320	333	17	37	344320
imitace nerez/chrom	160	173	17	37	344317
	224	237	17	37	344319
	320	333	17	37	344321
	448	461	17	37	344323
	512	525	17	37	344325

MARIA

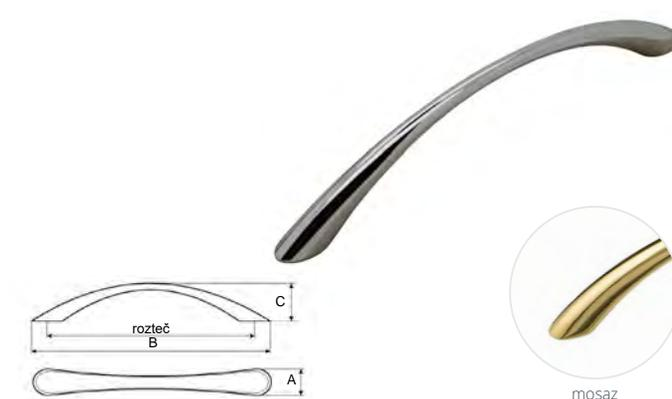

BAREVNÉ PŘÍKRYTÍ	ROZTEČ	B	A	C	KÓD
bílá lak	96	115	8	23	063635
	128	156	8	23	420361
černá lak	96	115	8	23	063634
	128	156	8	23	391043
chrom lesklý	96	115	8	23	063631
	128	156	8	23	056942
chrom satén	96	115	8	23	063633
	128	156	8	23	063630
mosaz	96	115	8	23	011514
	128	156	8	23	078124
nikl broušený	96	115	8	23	063632
	128	156	8	23	117401
nikl satén	96	115	8	23	011515
	128	156	8	23	097443

7.1 KOVOVÉ ÚCHYTKY 7 ÚCHYTKY, VĚŠÁKY A PROFILY

MARINA

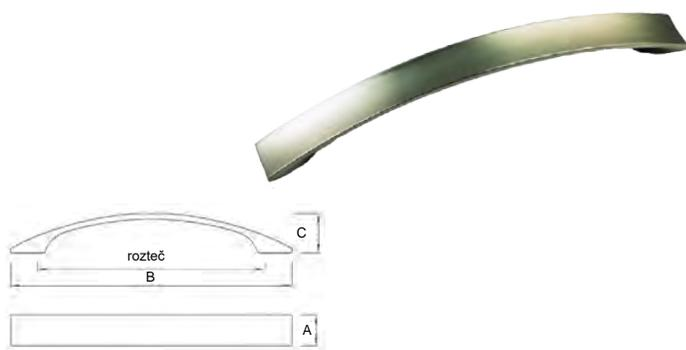

BAREVNÉ PŘÍKRYTÍ	ROZTEČ	B	A	C	KÓD
chrom satén	160	198	22	27,5	344327
nikl broušený	160	198	22	27,5	344326

MEDILA

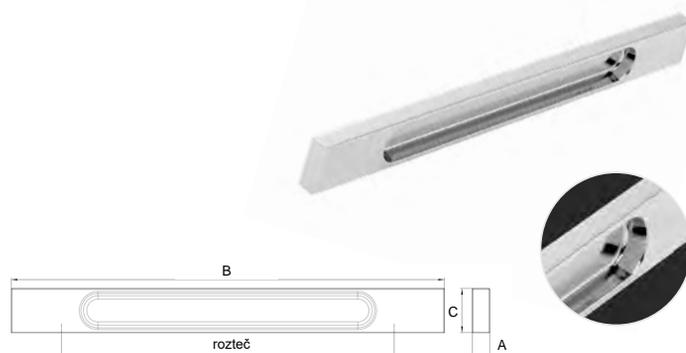

BAREVNÉ PŘÍKRYTÍ	ROZTEČ	B	A	C	KÓD
chrom lesklý	192	250	10	25	802113
	448	500	10	25	802114
	704/576	760	10	25	802115

MIA

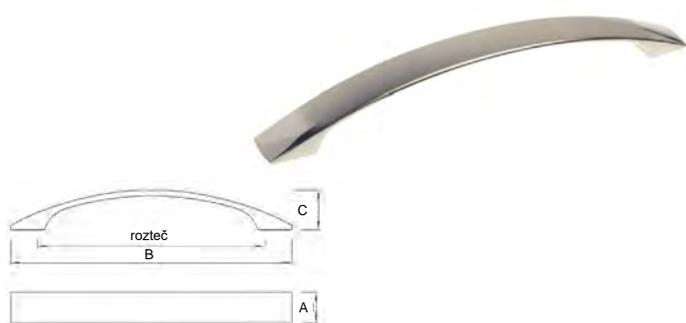

BAREVNÉ PŘÍKRYTÍ	ROZTEČ	B	A	C	KÓD
chrom satén	160	180	21	25	413558
nikl leštěný	160	180	21	25	413560



MEDILA, chrom lesklý

MILY

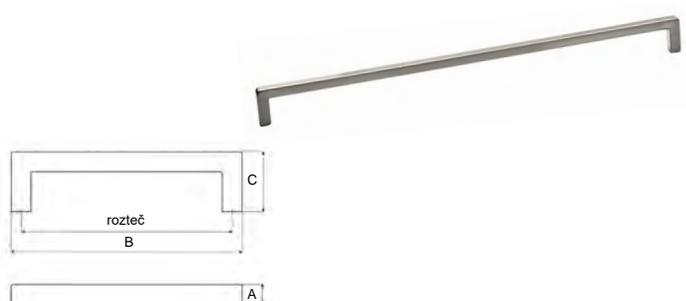

BAREVNÉ PŘÍKRYTÍ	ROZTEČ	B	A	C	KÓD
chrom satén	192	200	8	27	376092
	320	328	8	27	376093
	448	459	8	27	376094
nikl broušený	96	104	8	27	376095
	128	136	8	27	376096
	160	168	8	27	376097
	192	200	8	27	376098
	320	328	8	27	376099
	448	456	8	27	376100

MONICA

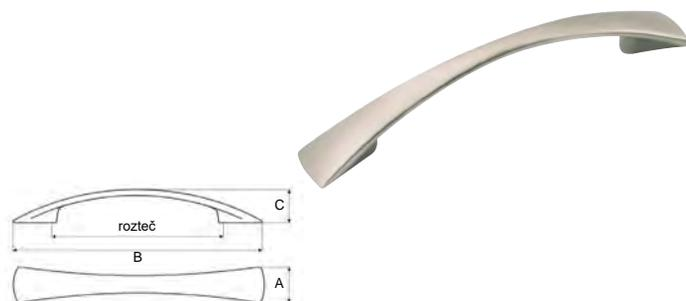

BAREVNÉ PŘÍKRYTÍ	ROZTEČ	B	A	C	KÓD
chrom lesklý	96	138	20	24	011443
	128	184	20	24	103439
	96	138	20	24	011444
chrom satén	128	184	20	24	063629
	96	138	20	24	035251
	128	184	20	24	011445
nikl satén	96	138	20	24	011513
	128	184	20	24	021520



NOEMI, černá



DARA, chrom lesklý

7.1 KOVOVÉ ÚCHYTKY

7 ÚCHYTKY, VĚŠÁKY A PROFILY

NEIVA

BAREVNÉ PROVEDENÍ	ROZTEČ	B	A	C	KÓD
antracit lesklý	160	177	15	30	655806
	320	337	15	30	754619
antracit matný	160	177	15	30	642404
	320	337	15	30	660995
chrom lesklý	128	145	15	30	519007
	160	177	15	30	748779
	192	209	15	30	530413
	320	337	15	30	519006
nikl jemně broušený	128	145	15	30	542710
	160	177	15	30	539594
	192	209	15	30	527316
	320	337	15	30	532153

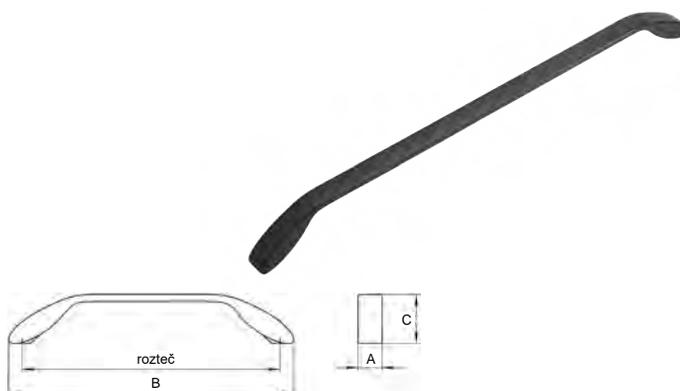

NICOLE

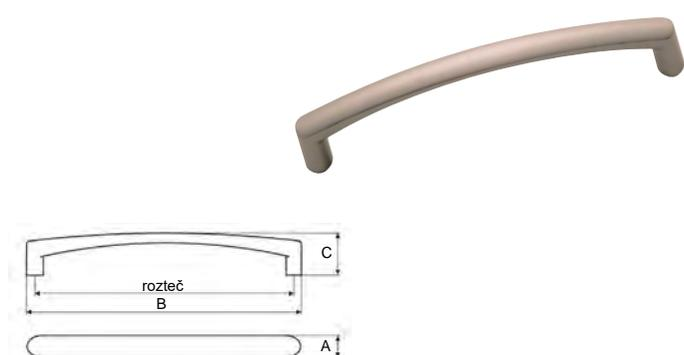

BAREVNÉ PROVEDENÍ	ROZTEČ	B	A	C	KÓD
nikl satén	128	138	13	25	011457



NINA

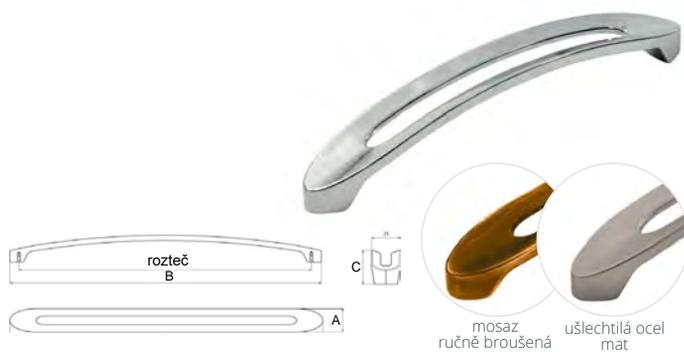

BAREVNÉ PROVEDENÍ	ROZTEČ	B	A	C	KÓD
chrom lesklý	160	180	25	29	763381
	320	340	25	29	770581
mosaz ručně broušená	160	180	25	29	770913
	320	340	25	29	751790
nikl jemně broušený	160	180	25	29	692227
	320	340	25	29	687655
ušlechtilá ocel mat	160	180	25	29	719958
	320	340	25	29	719957
železo broušené	160	180	25	29	737152
	320	340	25	29	707114



NOEMI



BAREVNÉ PROVEDENÍ	ROZTEČ	B	A	C	KÓD
černá	128	146	20	28	762445
	160	178	20	28	763002
	192	210	20	28	763003
	256	274	20	28	763004
	320	338	20	28	763005
chrom lesklý	128	146	20	28	310091
	160	178	20	28	683331
	192	210	20	28	310097
	256	274	20	28	310098
	320	338	20	28	310099
chrom satén	128	146	20	28	293899
	160	178	20	28	219554
	192	210	20	28	224267
	256	274	20	28	224270
	320	338	20	28	224271
nikl broušený	416	434	20	28	671630
	128	146	20	28	689542
	160	178	20	28	689543
	192	210	20	28	667614
	256	274	20	28	689546
nikl satén	320	338	20	28	689549
	416	434	20	28	712543
	128	146	20	28	310100
	160	178	20	28	219552
	192	210	20	28	223176
	256	274	20	28	224266
	320	338	20	28	223732

■ dodání do 24 hodin
 ■ dodání do 5 dní
 ■ na objednávku / na dotaz

7.1 KOVOVÉ ÚCHYTKY 7 ÚCHYTKY, VĚŠÁKY A PROFILY

PABLOS

BAREVNÉ PŘEVODENÍ	ROZTEČ	B	A	C	KÓD
hliník/chrom lesklý	160	180	20	30	344235
	224	244	20	30	344237
	320	340	20	30	344239
	416	436	20	30	344241
	512	532	20	30	344243
	640	660	20	30	344245
hliník/chrom satén	736	756	20	30	344247
	160	180	20	30	377280
	224	244	20	30	375794
	320	340	20	30	375795
	416	436	20	30	375796
	512	532	20	30	375797
imitace nerezí	640	660	20	30	375798
	736	756	20	30	375799
	160	180	20	30	391023
	224	244	20	30	391024
	320	340	20	30	391025
	416	436	20	30	394637
imitace nerezí/chrom	512	532	20	30	395739
	640	660	20	30	395740
	736	756	20	30	395741
	160	180	20	30	344236
	224	244	20	30	344238
	320	340	20	30	344240
	416	436	20	30	344242
	512	532	20	30	344244
	640	660	20	30	344246
	736	756	20	30	344248

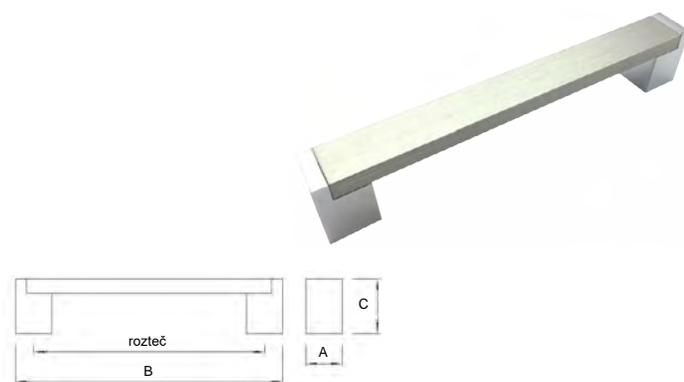

LESA, chrom lesklý

PAOLA

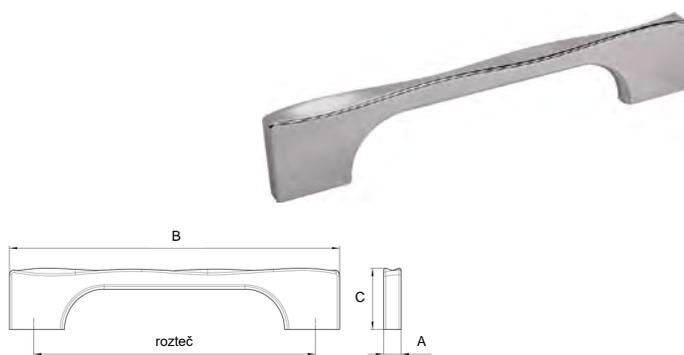

BAREVNÉ PŘEVODENÍ	ROZTEČ	B	A	C	KÓD
chrom lesklý	128	150	8	27	802100
	256	270	8	27	802102
nikl jemně broušený	128	150	8	27	802101
	256	270	8	27	802103

PORTOS



BAREVNÉ PŘEVODENÍ	ROZTEČ	B	A	C	KÓD
hliník	96	105	17	30	553014
	128	137	17	30	344298
	160	169	17	30	344300
	192	201	17	30	344302
	224	233	17	30	344304
	320	329	17	30	344306
	448	457	17	30	344308
	544	553	17	30	344310
	640	649	17	30	344312
	736	745	17	30	344314
imitace nerezí	96	105	17	30	553015
	128	137	17	30	344299
	160	169	17	30	344301
	192	201	17	30	344303
	224	233	17	30	344305
	320	329	17	30	344307
	448	457	17	30	344309
	544	553	17	30	344311
	640	649	17	30	344313
	736	745	17	30	344315

PARMA



BAREVNÉ PŘEVODENÍ	ROZTEČ	B	A	C	KÓD
chrom lesklý	128	138	17	25	351045
nerez finiš	128	138	17	25	351075

7.1 KOVOVÉ ÚCHYTKY

7 ÚCHYTKY, VĚŠÁKY A PROFILY

RADOS

BAREVNÉ PŘÍKRYTÍ	ROZTEČ	B	A	C	KÓD
hliník	128	140	8	34	344263
	160	172	8	34	344266
	224	236	8	34	344269
	320	332	8	34	344272
	416	428	8	34	344275
chrom lesklý	128	140	8	34	344264
	160	172	8	34	344267
	224	236	8	34	344270
	320	332	8	34	344273
	416	428	8	34	344276
imitace nerez	128	140	8	34	344265
	160	172	8	34	344268
	224	236	8	34	344271
	320	332	8	34	344274
	416	428	8	34	344277

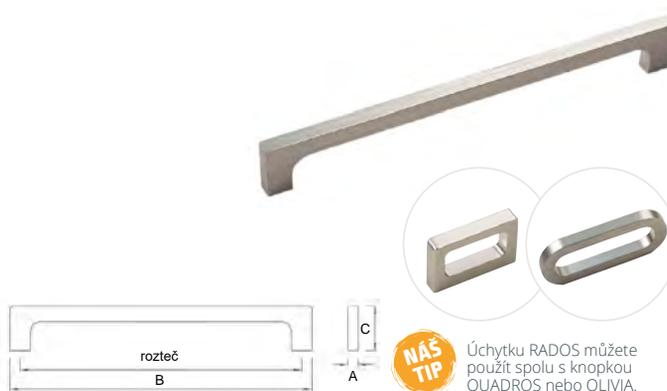

NÁŠ TIP

Úchytka RADOS můžete použít spolu s knopkou QUADROS nebo OLIVIA.

RAVENA

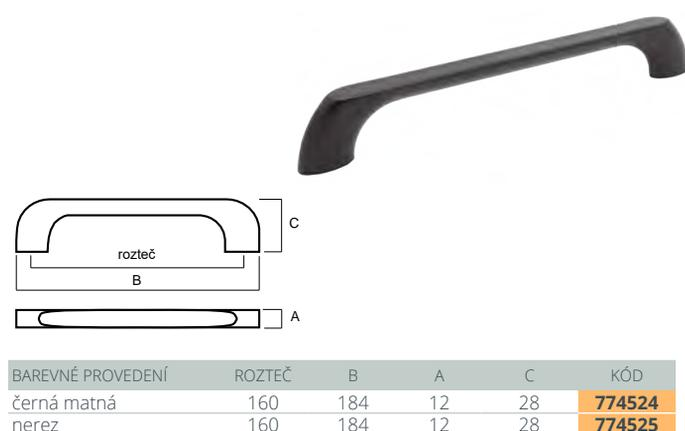

BAREVNÉ PŘÍKRYTÍ	ROZTEČ	B	A	C	KÓD
černá matná	160	184	12	28	774524
nerez	160	184	12	28	774525

REBEKA

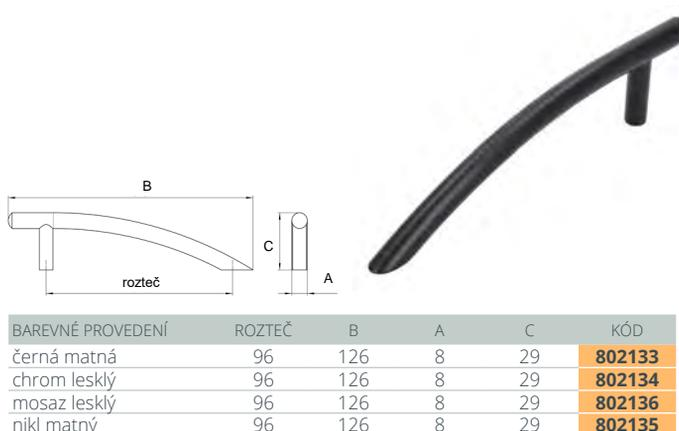

BAREVNÉ PŘÍKRYTÍ	ROZTEČ	B	A	C	KÓD
černá matná	96	126	8	29	802133
chrom lesklý	96	126	8	29	802134
mosaz lesklý	96	126	8	29	802136
nikl matný	96	126	8	29	802135

RIALTO

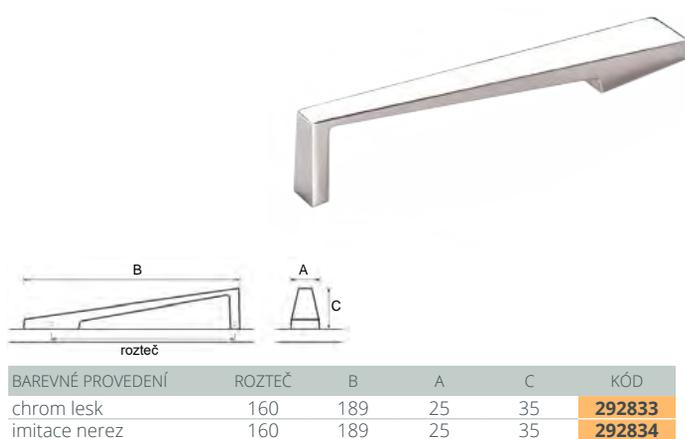

BAREVNÉ PŘÍKRYTÍ	ROZTEČ	B	A	C	KÓD
chrom lesk	160	189	25	35	292833
imitace nerez	160	189	25	35	292834



REBEKA, chrom lesklý

RIVERA

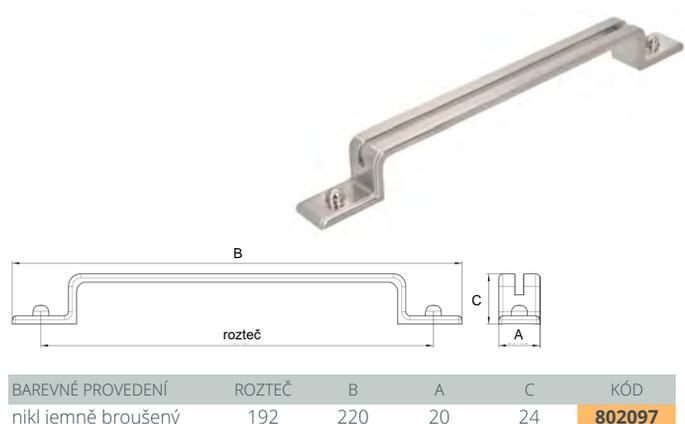

BAREVNÉ PŘÍKRYTÍ	ROZTEČ	B	A	C	KÓD
nikl jemně broušený	192	220	20	24	802097

ROLA

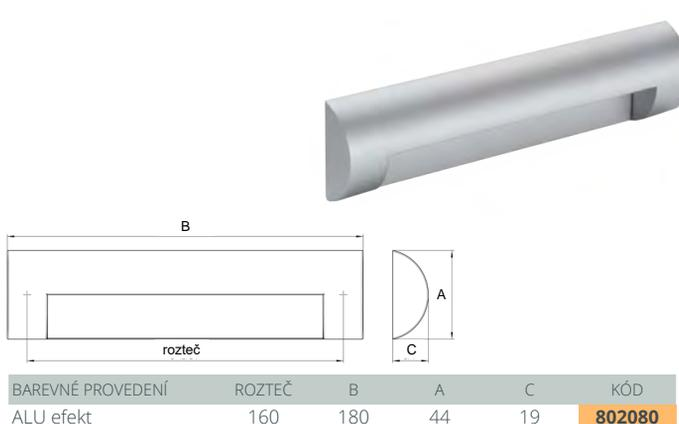

BAREVNÉ PŘÍKRYTÍ	ROZTEČ	B	A	C	KÓD
ALU efekt	160	180	44	19	802080

dodání do 24 hodin dodání do 5 dní na objednávku / na dotaz

7.1 KOVOVÉ ÚCHYTKY 7 ÚCHYTKY, VĚŠÁKY A PROFILY

ROVIGO

BAREVNÉ PŘÍRODNÍ	ROZTEČ	B	A	C	KÓD
hliník elox	64	79	16	25	664650
	96	111	16	25	666623
	128	143	16	25	666625
	160	175	16	25	666627
	192	207	16	25	666629
chrom lesklý	224	239	16	25	666631
	64	79	16	25	664648
	96	111	16	25	666613
	128	143	16	25	666614
	160	175	16	25	351149
nerez kartáčovaná	192	207	16	25	666615
	224	239	16	25	351295
	64	79	16	25	664649
	96	111	16	25	666617
	128	143	16	25	666619
nerez kartáčovaná	160	175	16	25	351112
	192	207	16	25	666621
	224	239	16	25	351205

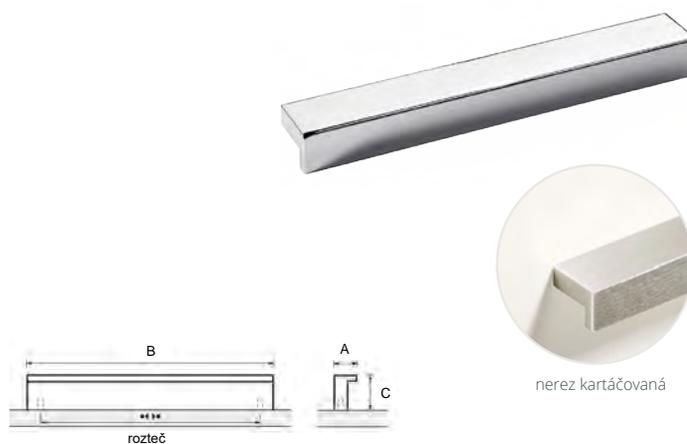

nerez kartáčovaná

SALONA

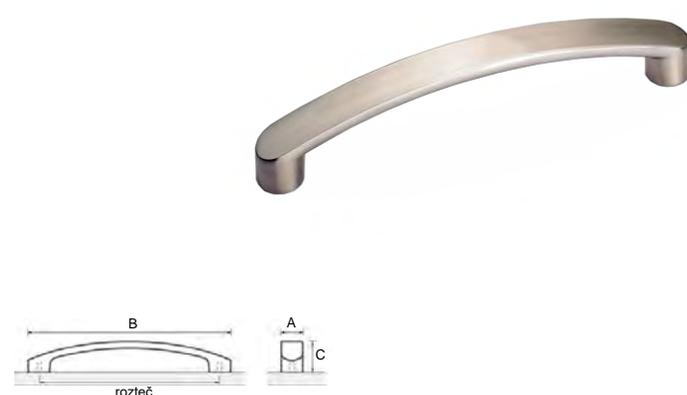

BAREVNÉ PŘÍRODNÍ	ROZTEČ	B	A	C	KÓD
nerez finiš	160	180	19	27	351098

SAM

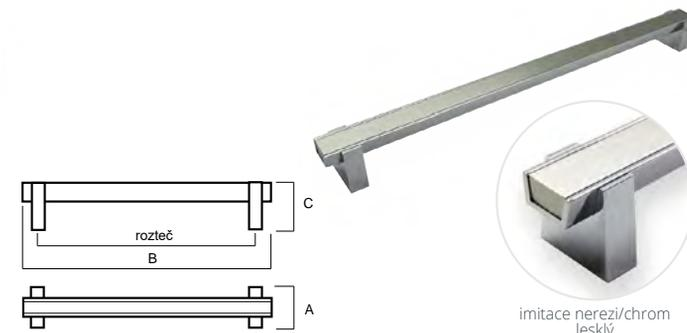

imitace nerez/chrom lesklý

BAREVNÉ PŘÍRODNÍ	ROZTEČ	B	A	C	KÓD
imitace nerez/chrom lesklý	160	192	20	30	505851
	224	256	20	30	505852
	320	352	20	30	505853
	416	448	20	30	505854

SAMARA

BAREVNÉ PŘÍRODNÍ	ROZTEČ	B	A	C	KÓD
elox přírodní matný	128/224	252	10	29	298323
	160/256	284	10	29	362985
	192/288	316	10	29	652694
	224/320	348	10	29	363007
	288/384	412	10	29	298902
	320/416	444	10	29	754618
	352/448	476	10	29	743252
	384/480	508	10	29	664094
	480/576	604	10	29	352545
	640/736	764	10	29	349327
chrom lesklý	128/224	252	10	29	298327
	160/256	284	10	29	638089
	192/288	316	10	29	357322
	224/320	348	10	29	342733
	288/384	412	10	29	541867
	320/416	444	10	29	370609
	352/448	476	10	29	708259
	384/480	508	10	29	749854
	480/576	604	10	29	381360
	640/736	764	10	29	342732
nikl jemně broušený	128/224	252	10	29	298328
	160/256	284	10	29	353452
	192/288	316	10	29	353449
	224/320	348	10	29	314724
	288/384	412	10	29	366844
	320/416	444	10	29	295976
	352/448	476	10	29	353446
	384/480	508	10	29	362868
480/576	604	10	29	364772	
640/736	764	10	29	314723	

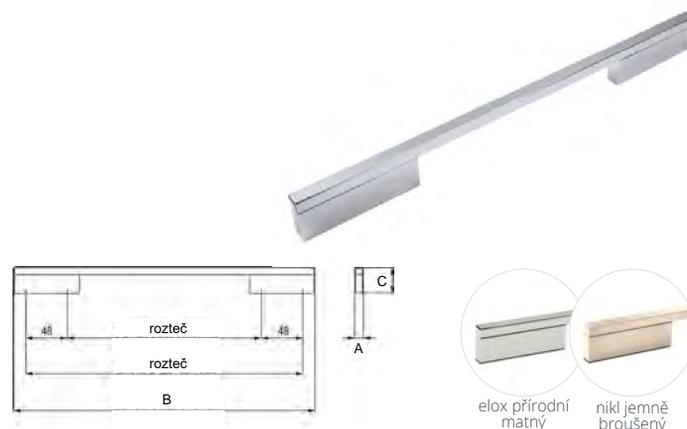

elox přírodní matný nikl jemně broušený



SAMARA, nikl jemně broušený

7.1 KOVOVÉ ÚCHYTKY

7 ÚCHYTKY, VĚŠÁKY A PROFILY

SANTA

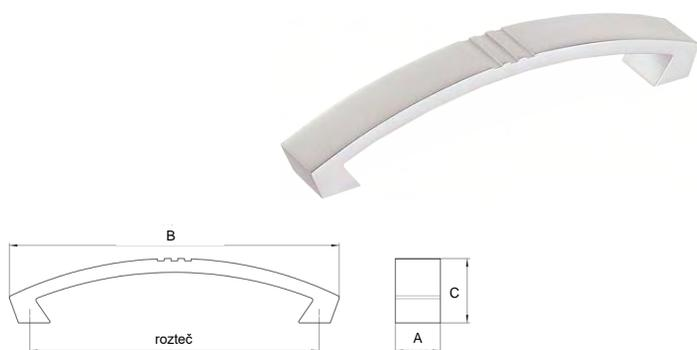

BAREVNÉ PROVEDENÍ	ROZTEČ	B	A	C	KÓD
alu efekt	128	146	20	28	802077

SÁRA

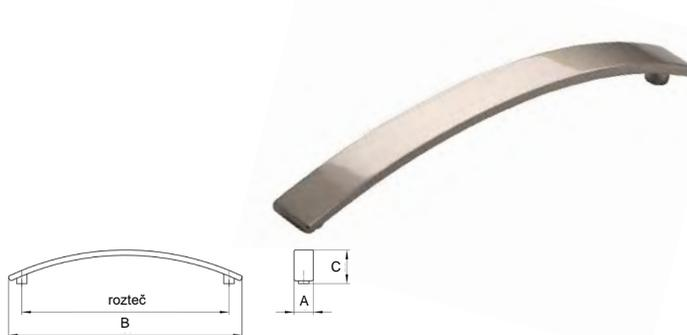

BAREVNÉ PROVEDENÍ	ROZTEČ	B	A	C	KÓD
antracit lesklý	160	181	15	25,5	647892
chrom lesklý	160	181	15	25,5	772698
nikl jemně broušený	160	181	15	25,5	567343
železo broušené	160	181	15	25,5	723340

SÁVA

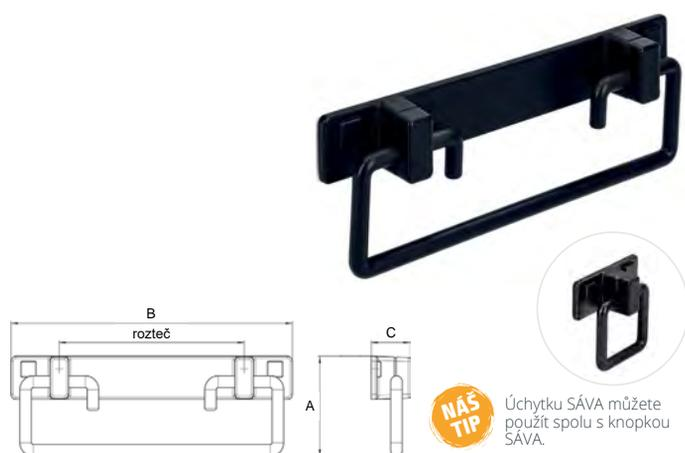

BAREVNÉ PROVEDENÍ	ROZTEČ	B	A	C	KÓD
černá mat	96	146	51	20	787887



SERENA

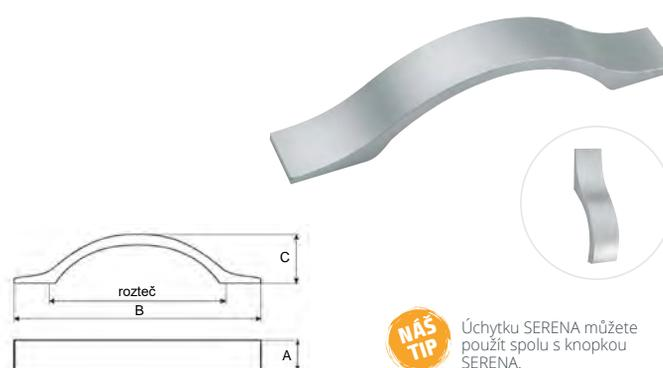

BAREVNÉ PROVEDENÍ	ROZTEČ	B	A	C	KÓD
chrom satén	96	140	20	29	217250
nikl broušený	96	140	20	29	365349

SEBI

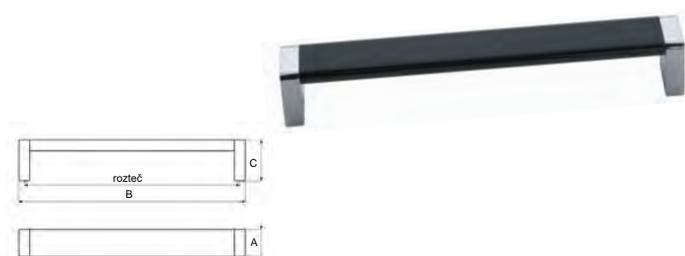

BAREVNÉ PROVEDENÍ	ROZTEČ	B	A	C	KÓD
bílá/chrom	96	104	20	30	511009
	128	136	20	30	511010
	256	264	20	30	511011
černá/chrom	96	104	20	30	511012
	128	136	20	30	511013
	256	264	20	30	511014



7.1 KOVOVÉ ÚCHYTKY 7 ÚCHYTKY, VĚŠÁKY A PROFILY

SIERA

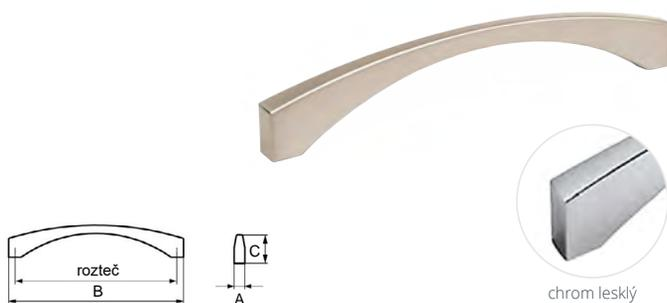

BAREVNÉ PŘEVODENÍ	ROZTEČ	B	A	C	KÓD
antik ocel efekt	160	173	12	31	669891
	320	333	12	31	662423
chrom lesklý	160	173	12	31	414307
	320	333	12	31	426906
nikl jemně broušený	160	173	12	31	409755
	320	333	12	31	409757



SIERA, antik ocel efekt

SIMA

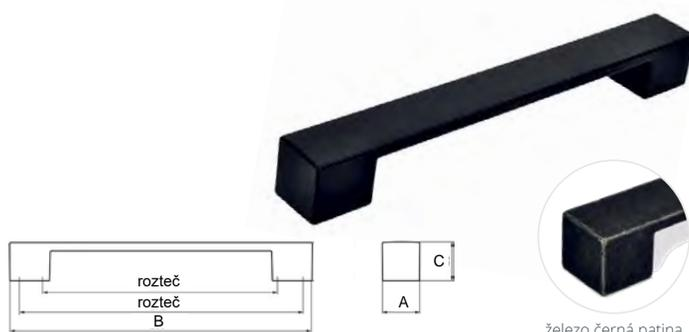

BAREVNÉ PŘEVODENÍ	ROZTEČ	B	A	C	KÓD
černá mat	160/192	205	25	25	011664
nikl jemně broušený	160/192	205	25	25	750088
železo černá patina	160/192	205	25	25	723805

STABIA

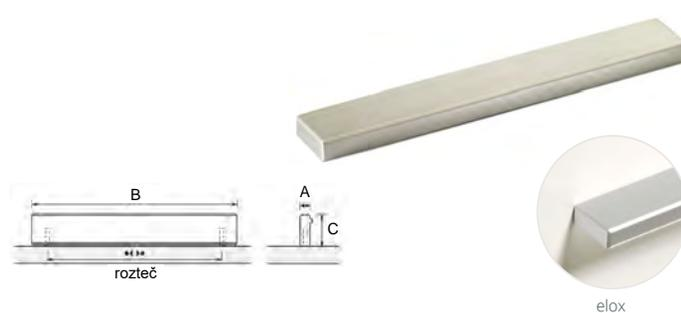

BAREVNÉ PŘEVODENÍ	ROZTEČ	B	A	C	KÓD
elox	64	76	8	20	664636
	96	108	8	20	058847
	128	140	8	20	071280
	160	172	8	20	063409
	192	204	8	20	664637
	224	236	8	20	044979
nerez kartáčovaná	64	76	8	20	724075
	96	108	8	20	664640
	128	140	8	20	664641
	160	172	8	20	664642
	192	204	8	20	664639
	224	236	8	20	665094

TALA

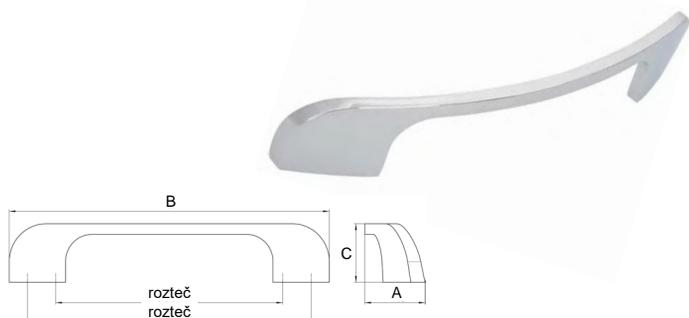

BAREVNÉ PŘEVODENÍ	ROZTEČ	B	A	C	KÓD
chrom lesklý	96/128	138	28	33	802091
	128/160	180	34	32	802093
	192	260	25	32	802095
nikl jemně broušený	96/128	138	28	33	802092
	128/160	180	34	32	802094
	192	260	25	32	802096



TALA, chrom lesklý

TALARA



BAREVNÉ PŘEVODENÍ	ROZTEČ	B	A	C	KÓD
chrom lesklý	128	136	14	33	802090

7.1 KOVOVÉ ÚCHYTKY

7 ÚCHYTKY, VĚŠÁKY A PROFILY

TORNEA

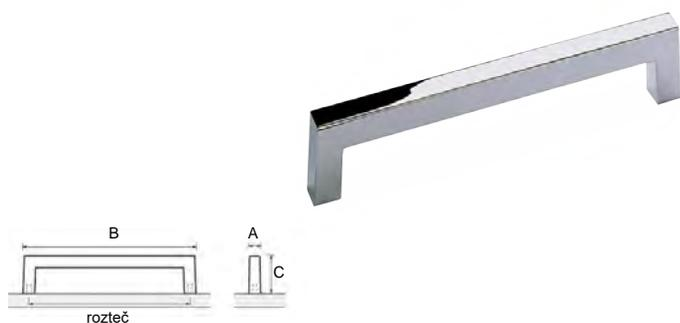

BAREVNÉ PROVEDENÍ	ROZTEČ	B	A	C	KÓD
chrom lesklý	128	138	10	32	351074
	192	202	10	32	351159
imitace nerezí	128	138	10	32	351134
	192	202	10	32	351198

UGO

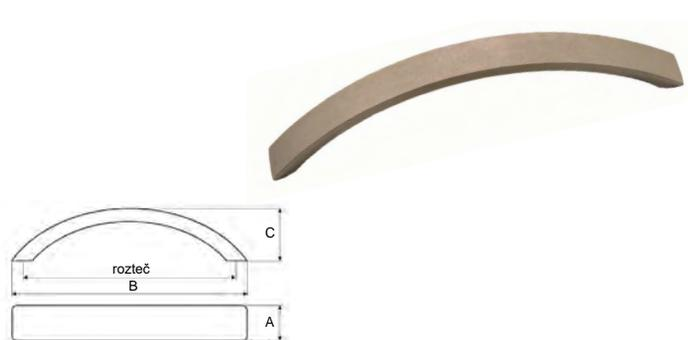

BAREVNÉ PROVEDENÍ	ROZTEČ	B	A	C	KÓD
chrom lesklý	128	145	20	30	676918
chrom satén	128	145	20	30	413452
nikl satén	128	145	20	30	063601

VALEDA

BAREVNÉ PROVEDENÍ	ROZTEČ	B	A	C	KÓD
bílá lesklá	48	70	40	20	763888
	128	145	40	20	787891
černá mat	48	70	40	20	763892
	128	145	40	20	787892
chrom lesklý	48	70	40	20	787897
	128	145	40	20	787893
mosaz ručně broušená	48	70	40	20	762151
	128	145	40	20	787894
nikl jemně broušený	48	70	40	20	755900
	128	145	40	20	787895
železo broušené	48	70	40	20	751451
	128	145	40	20	787896

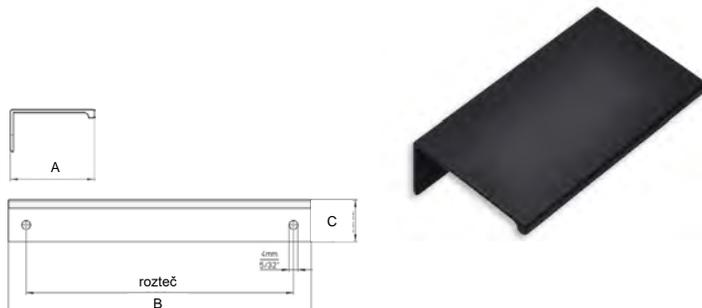

VANTANIA

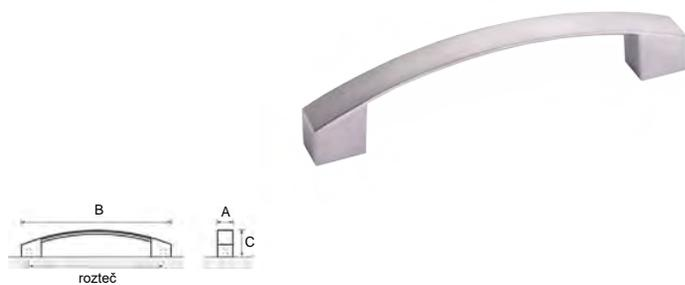

BAREVNÉ PROVEDENÍ	ROZTEČ	B	A	C	KÓD
chrom lesklý	128	144	14	27	350979
chrom matný	128	144	14	27	350990
nerez finiš	128	144	14	27	350989

VERONICA



NÁŠ TIP

Úchytka VERONICA můžete použít spolu s knopkou CATARINA.

BAREVNÉ PROVEDENÍ	ROZTEČ	B	A	C	KÓD
nikl broušený	128	144	15	30	365353



SIMA, černá mat



VANTANIA, chrom matný

7.1 KOVOVÉ ÚCHYTKY 7 ÚCHYTKY, VĚŠÁKY A PROFILY

VIANA

BAREVNÉ PŘÍKRYTÍ	ROZTEČ	B	A	C	KÓD
černá mat	96	110	12	32	787903
	128	142	12	32	787898
	160	174	12	32	343214
	192	206	12	32	124603
	320	334	12	32	786991
ušlechtilá ocel mat	96	110	12	32	787904
	128	142	12	32	787899
	160	174	12	32	787900
	192	206	12	32	787901
	320	334	12	32	787902



VIANA, černá mat



NÁŠ TIP

Úchytka VIANA můžete použít spolu s věšákem a knopkami VIANA.

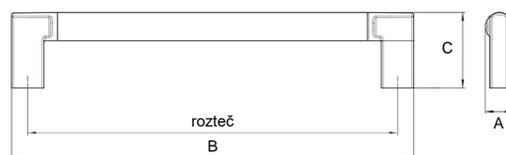

VIOLETA

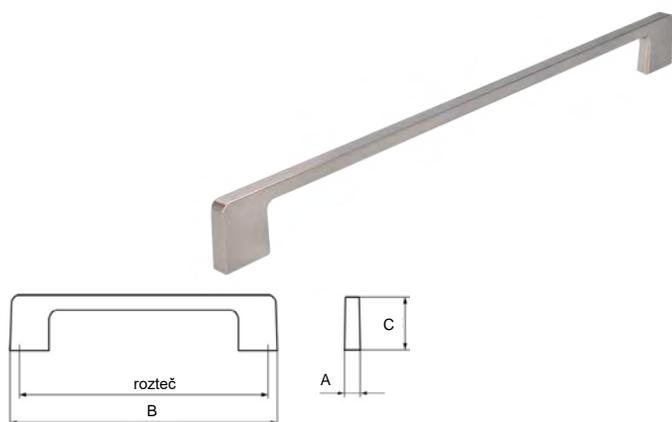

BAREVNÉ PŘÍKRYTÍ	ROZTEČ	B	A	C	KÓD
antik ocel efekt	128	140	9	30	638254
	160	172	9	30	683197
	192	204	9	30	672161
černá mat	128	140	9	30	754951
	160	172	9	30	794407
	192	204	9	30	710900
chrom lesklý	96	108	9	30	780009
	128	140	9	30	356626
	160	172	9	30	355827
	192	204	9	30	292275
	320	332	9	30	736378
nikl jemně broušený	96	108	9	30	739290
	128	140	9	30	351943
	160	172	9	30	366265
	192	204	9	30	387865
	320	332	9	30	741079
železo broušené	160	172	9	30	678926
	192	204	9	30	688213



VIOLETA, antik ocel efekt

RUSTIKÁLNÍ ÚCHYTKY

ADINA



cín pálený

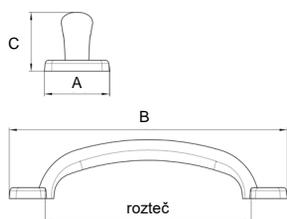

Úchytka ADINA můžete použít spolu s knopkou ADINA.

BAREVNÉ PROVEDENÍ	ROZTEČ	B	A	C	KÓD
cín pálený	96	130	30	27	802079
černá matná	96	130	30	27	802078
staromosaz	96	130	30	27	751259
starostříbrná	96	130	30	27	774535

AGLIA

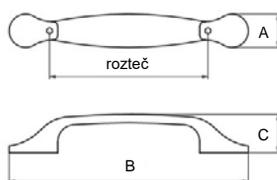

Úchytka AGLIA můžete použít spolu s knopkou AGLIA.

BAREVNÉ PROVEDENÍ	ROZTEČ	B	A	C	KÓD
staromosaz kartáčovaný	96	145	20	22	196411

ALBERTA

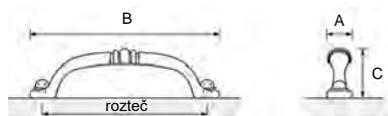

BAREVNÉ PROVEDENÍ	ROZTEČ	B	A	C	KÓD
cín antik	96	110	14	28	350958
mosaz antik	96	110	14	28	350957
nerez finiš	96	110	14	28	350959

ALIDA

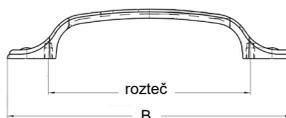

BAREVNÉ PROVEDENÍ	ROZTEČ	B	A	C	KÓD
staromosaz	96	135	13	23	118911

AMELIA

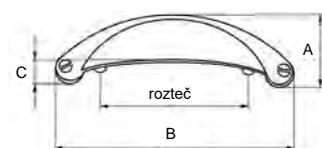

BAREVNÉ PROVEDENÍ	ROZTEČ	B	A	C	KÓD
nikl jemně broušený	64	103	31,5	24,5	294486
staromosaz	64	103	31,5	24,5	286969
ušlechtilá ocel matná	64	103	31,5	24,5	296563
železo broušené	64	103	31,5	24,5	297159



ADINA, staromosaz

7.2 RUSTIKÁLNÍ ÚCHYTKY 7 ÚCHYTKY, VĚŠÁKY A PROFILY

ARDENIA



porcelán popraskaný porcelán porcelán s kvítkem

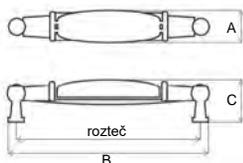

NÁŠ TIP

Úchytku ARDENIA můžete použít spolu s knopkou TOSCA.

BAREVNÉ PŘEVODENÍ	ROZTEČ	B	A	C	KÓD
zlatá antik/porcelán	96	122	16	25	680457
zlatá antik/porcelán popraskaný	96	122	16	25	680459
zlatá antik/porcelán s kvítkem	96	122	16	25	680460
zlatá antik/porcelán lístky	96	122	16	25	680458

ARLETA



starostříbrná rez efekt

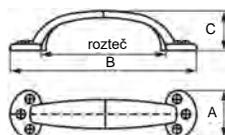

BAREVNÉ PŘEVODENÍ	ROZTEČ	B	A	C	KÓD
rez efekt	96	143	36	30	697675
staromosaz	96	143	36	30	711287
starostříbrná	96	143	36	30	757394

CORDUBA

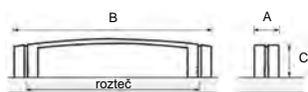

BAREVNÉ PŘEVODENÍ	ROZTEČ	B	A	C	KÓD
cínová	128	146	18	28	043753

CUBATA

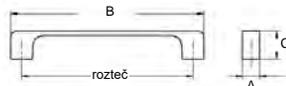

BAREVNÉ PŘEVODENÍ	ROZTEČ	B	A	C	KÓD
měď antik	96	108	16	27	680471
	128	138	16	27	680474
	160	172	18	27	680477
nikl černý broušený	96	108	16	27	680472
	128	138	16	27	680475
	160	172	18	27	680478
zlatá antik	96	108	16	27	680470
	128	138	16	27	680473
	160	172	18	27	680476

DIVERA



porcelán s kvítkem porcelán s lístkem

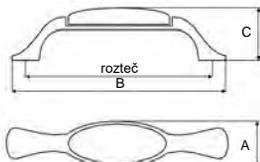

BAREVNÉ PŘEVODENÍ	ROZTEČ	B	A	C	KÓD
zlatá antik/porcelán	96	128	19	30	680454
zlatá antik/porcelán s kvítky	96	128	19	30	680456
zlatá antik/porcelán s lístky	96	128	19	30	680455

EGARA



stříbrný antik mosaz antik

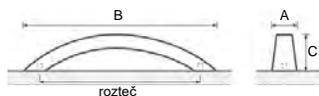

BAREVNÉ PŘEVODENÍ	ROZTEČ	B	A	C	KÓD
bronz antik	128	155	20	30	160739
mosaz antik	128	155	20	30	160740
stříbrný antik	128	155	20	30	160741

7.2 RUSTIKÁLNÍ ÚCHYTKY

7 ÚCHYTKY, VĚŠÁKY A PROFILY

GRETA

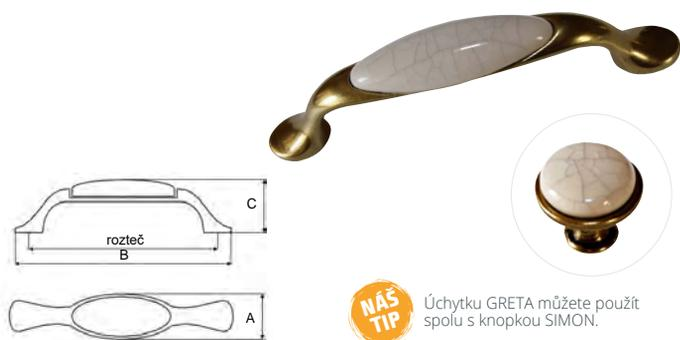

NÁŠ TIP

Úchytka GRETA můžete použít spolu s knopkou SIMON.

BAREVNÉ PŘÍKRYTÍ	ROZTEČ	B	A	C	KÓD
staromosaz/popráskaný porcelán krémový	96	128	17	28	365355

HAIDA

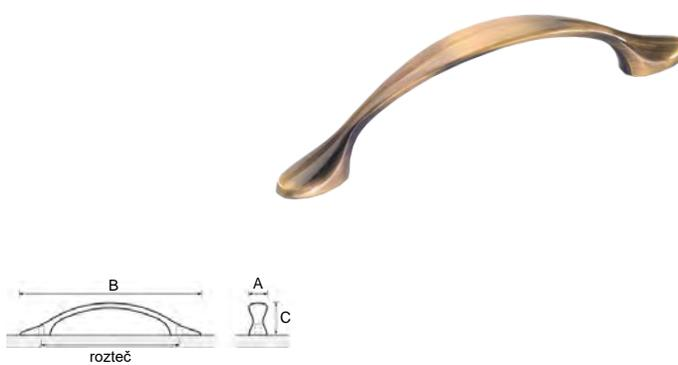

BAREVNÉ PŘÍKRYTÍ	ROZTEČ	B	A	C	KÓD
mosaz antik	96	126	13	22	350882
nerez finiš	96	126	13	22	350907

LAVIDA



NÁŠ TIP

Úchytka LAVIDA můžete použít spolu s knopkou LAVIDA.

BAREVNÉ PŘÍKRYTÍ	ROZTEČ	B	A	C	KÓD
mosaz patina	76	118	12	21	680438
	96	138	12	22	680441
zlatá antik	76	118	12	21	680437
	96	138	12	22	680440

MADALEN

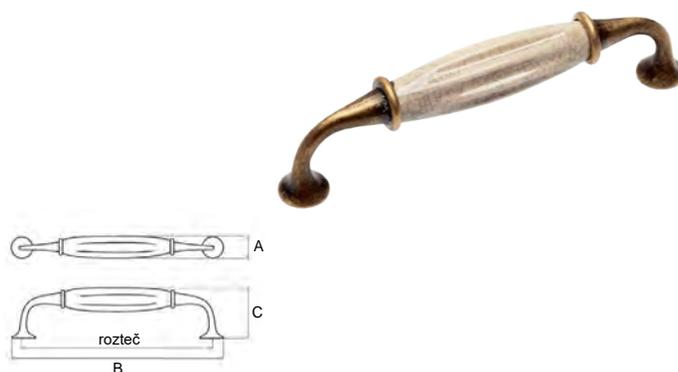

BAREVNÉ PŘÍKRYTÍ	ROZTEČ	B	A	C	KÓD
zlatá antik/porcelán popráskaný	128	147	18	34	680449

MARILIN

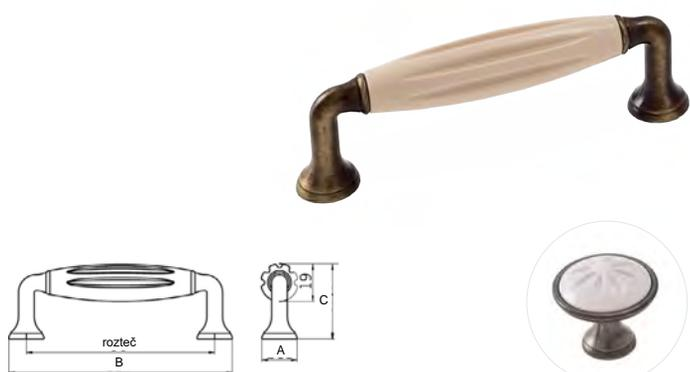

NÁŠ TIP

Úchytka MARILIN můžete použít spolu s knopkou MARILIN.

BAREVNÉ PŘÍKRYTÍ	ROZTEČ	B	A	C	KÓD
staromosaz brnír / plast béžový	96	114	18	37,5	186876
zinek / plast bílý	96	114	18	37,5	492923



MARILIN, staromosaz brnír / plast béžový

7.2 RUSTIKÁLNÍ ÚCHYTKY 7 ÚCHYTKY, VĚŠÁKY A PROFILY

MORANDA

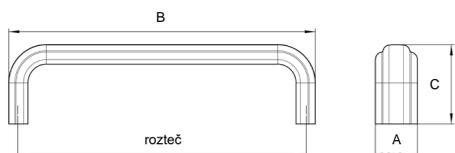

BAREVNÉ PROVEDENÍ	ROZTEČ	B	A	C	KÓD
staromosaz	96	102	14	26	802130

NATÁLIA

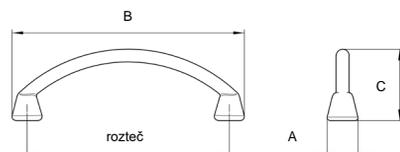

nikl
matný

BAREVNÉ PROVEDENÍ	ROZTEČ	B	A	C	KÓD
mosaz lesklá	64	74	10	22	802132
nikl matný	64	74	10	22	802131

OLVIA

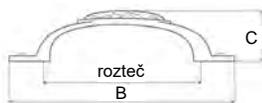

NÁŠ TIP

Úchytka OLVIA můžete použít spolu s knopkou OLVIA.

BAREVNÉ PROVEDENÍ	ROZTEČ	B	A	C	KÓD
zlatá antik/porcelán popraskaný	96	134	29	32	680428



OSIMO, cínová antik

OSIMO

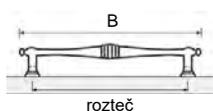

BAREVNÉ PROVEDENÍ	ROZTEČ	B	A	C	KÓD
cínová antik	96	120	13	22	350961
mosaz antik	96	120	13	22	350960

RIANA

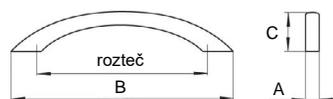

BAREVNÉ PROVEDENÍ	ROZTEČ	B	A	C	KÓD
staromosaz	76	113	14	21	011625

7.2 RUSTIKÁLNÍ ÚCHYTKY

7 ÚCHYTKY, VĚŠÁKY A PROFILY

RITA

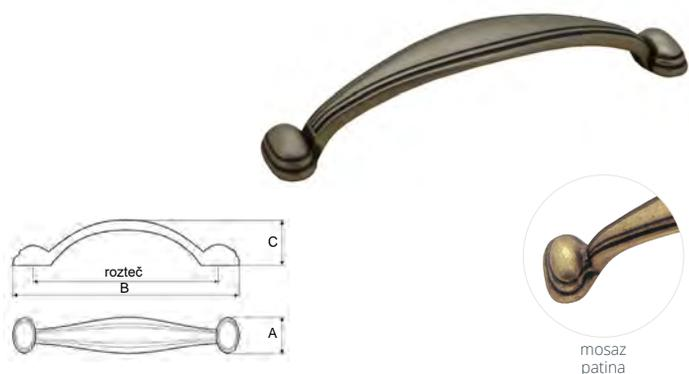

BAREVNÉ PŘÍKRYTÍ	ROZTEČ	B	A	C	KÓD
mosaz patina	96	110	18	22	365359
nikl patina	96	110	18	22	365360

ROSA



BAREVNÉ PŘÍKRYTÍ	ROZTEČ	B	A	C	KÓD
mosaz patina	96	120	23	25,5	365357
nikl patina	96	120	23	25,5	365358

SALACIA

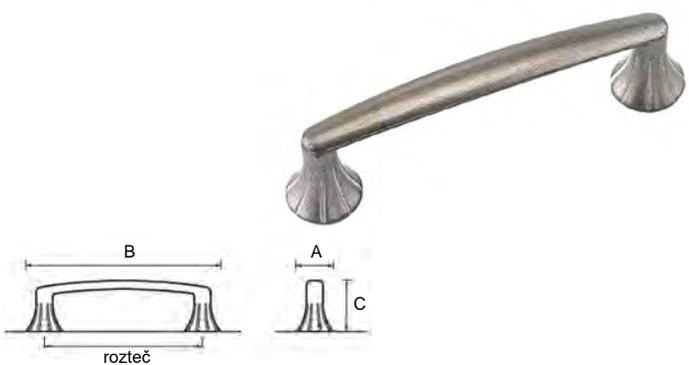

BAREVNÉ PŘÍKRYTÍ	ROZTEČ	B	A	C	KÓD
čínová	128	151	23	30	351132
stříbrná antik	128	151	23	30	350406

SIENA

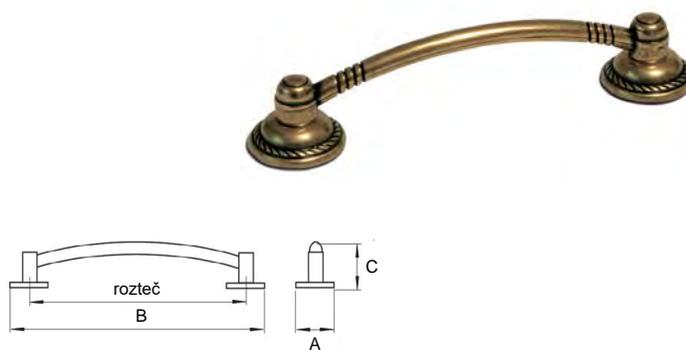

BAREVNÉ PŘÍKRYTÍ	ROZTEČ	B	A	C	KÓD
staromosaz	64	86	22	24	289981
	96	120	25	24	286144

SOTERA



BAREVNÉ PŘÍKRYTÍ	B	A	C	KÓD
staromosaz / plast béžový	34	158	66	411140

BAREVNÉ PŘÍKRYTÍ	B	A	C	KÓD
staromosaz / plast béžový	34	77	29	569818

7.2 RUSTIKÁLNÍ ÚCHYTKY 7 ÚCHYTKY, VĚŠÁKY A PROFILY

SPARTA



BAREVNÉ PŘEDVÍZÁNÍ	ROZTEČ	B	A	C	KÓD
mosaz patina	128	155	38	23	376862
nikl patina	128	155	38	23	376861



BAREVNÉ PŘEDVÍZÁNÍ	ROZTEČ	B	A	C	KÓD
mosaz patina		38	38	23	376858
nikl patina		38	38	23	376857



SPARTA, nikl patina

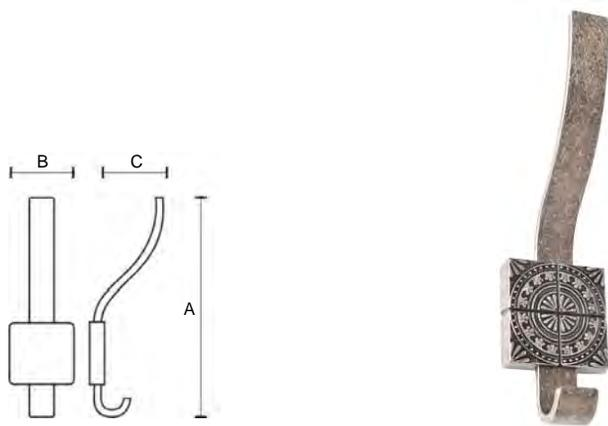

BAREVNÉ PŘEDVÍZÁNÍ	B	A	C	KÓD
mosaz patina	19/48	174	59	376860
nikl patina	19/48	174	59	376859

VERONA



BAREVNÉ PŘEDVÍZÁNÍ	ROZTEČ	B	A	C	KÓD
staromosaz	96	136	20	25	685576
starostříbrná	96	136	20	25	523963



VERONA, starostříbrná

VESNA

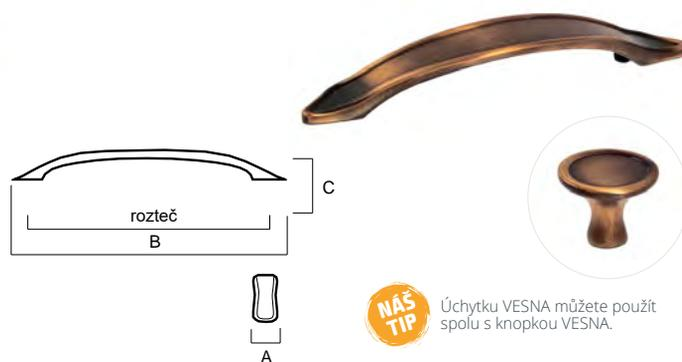

BAREVNÉ PŘEDVÍZÁNÍ	ROZTEČ	B	A	C	KÓD
staromosaz kartáčovaná	96	144	24	24	360526

NÁŠ TIP

Úchytka VESNA můžete použít spolu s knopkou VESNA.

VIENA

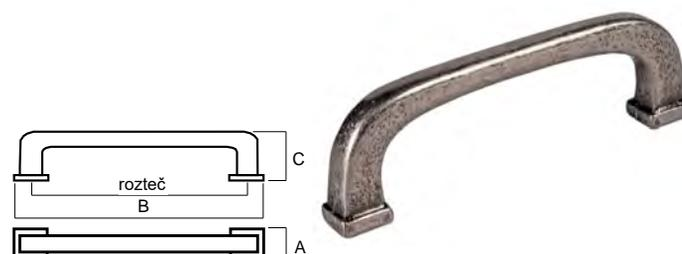

BAREVNÉ PŘEDVÍZÁNÍ	ROZTEČ	B	A	C	KÓD
staromosaz	96	110	13	34	646957
starostříbrná	96	110	13	34	625728

7.2 RUSTIKÁLNÍ ÚCHYTKY

7 ÚCHYTKY, VĚŠÁKY A PROFILY

VILANA



NÁŠ TIP Úchytka VILANA můžete použít spolu s knopkou VILANA.

BAREVNÉ PROVEDENÍ	ROZTEČ	B	A	C	KÓD
staromosaz brnír / plast béžový	96	130	22	27	126601
starostříbro / plast bílý	96	130	22	27	529262

VIRALA

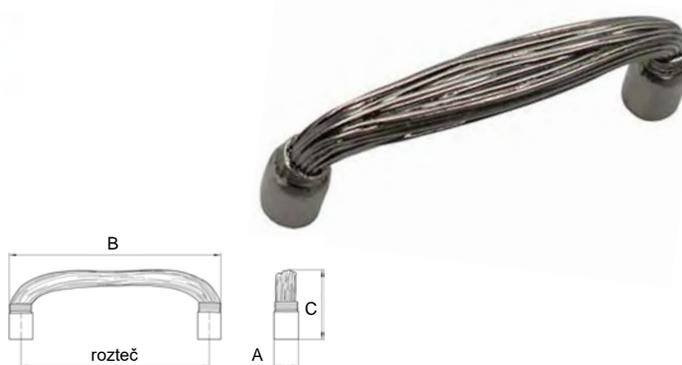

BAREVNÉ PROVEDENÍ	ROZTEČ	B	A	C	KÓD
staromosaz	96	108	13	34	802081
	128	140	13	34	802083
starostříbrná	64	76	13	34	802085
	96	108	13	34	802082
	128	140	13	34	802084

WITARA

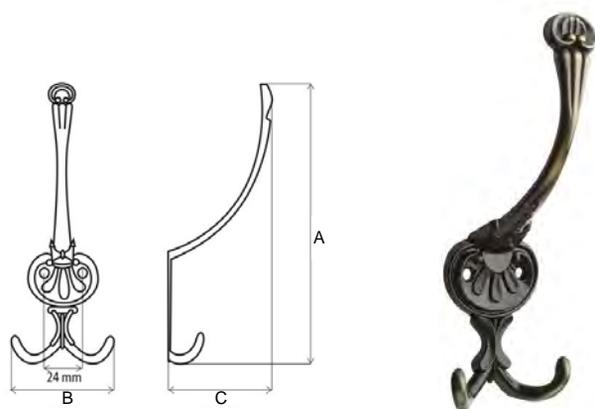

BAREVNÉ PROVEDENÍ	B	A	C	KÓD
zlatá antik	56	155	56	680484



ZAIRA



NÁŠ TIP Úchytka ZAIRA můžete použít spolu s knopkou ZAIRA.

BAREVNÉ PROVEDENÍ	ROZTEČ	B	A	C	KÓD
cínová	160	170	15	31	787905
mosaz ručně broušená	160	170	15	31	787906
železo černé patina	160	170	15	31	753253

7.3 KNOPKY

7 ÚCHYTKY, VĚŠÁKY A PROFILY

KNOPKY

ADINA

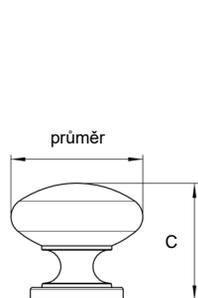

NAŠ TIP

Knopku ADINA můžete použít spolu s úchytkou ADINA.

BAREVNÉ PROVEDENÍ	PRŮMĚR	C	KÓD
cín	33	27	805183
černá	33	27	805182
staromosaz	33	27	032618
starostříbrná	33	27	163944



AGA

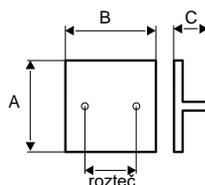

BAREVNÉ PROVEDENÍ	ROZTEČ	B	A	C	KÓD
nikl broušený	64	80	80	24	525612



ADINA, černá

AGLIA

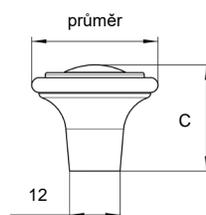

NAŠ TIP

Knopku AGLIA můžete použít spolu s úchytkou AGLIA.



BAREVNÉ PROVEDENÍ	PRŮMĚR	C	KÓD
staromosaz kartáčovaný	30	25	177644

ALMUS

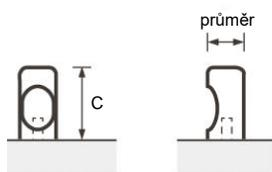

BAREVNÉ PROVEDENÍ	PRŮMĚR	C	KÓD
chrom lesklý	12	23	350901
chrom matný	12	23	350903
měď lesk	12	23	664633
nerozovový vzhled	12	23	350900
nikl matný	12	23	350902

ANGELA

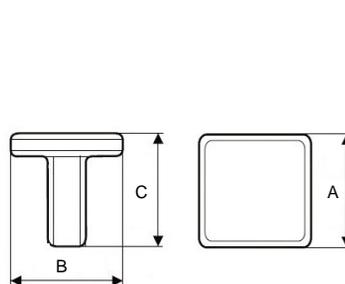

NAŠ TIP

Knopku ANGELA můžete použít spolu s úchytkou ANGELA.



BAREVNÉ PROVEDENÍ	B	A	C	KÓD
chrom lesklý	20	20	20	365341
chrom satén	20	20	20	365343
nikl satén	20	20	20	365342

7.3 KNOPKY

7 ÚCHYTKY, VĚŠÁKY A PROFILY

BLOCK

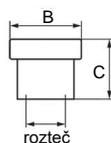

BLOCK, železo broušené

BAREVNÉ PROVEDENÍ	ROZTEČ	B	A	C	KÓD
bílá lesklá	16	29	14	24	787851
černá mat	16	29	14	24	762697
chrom lesklý	16	29	14	24	787852
mosaz ručně broušená	16	29	14	24	787853
nikl jemně broušený	16	29	14	24	116154
železo broušené	16	29	14	24	759727

CARLA

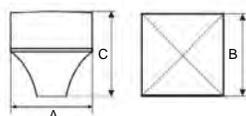

BAREVNÉ PROVEDENÍ	B	A	C	KÓD
mosaz patina	25	25	26	365361

CATARINA

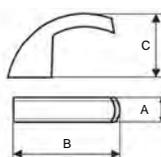

Knopku CATARINA můžete použít spolu s úchytkou VERONICA.

BAREVNÉ PROVEDENÍ	B	A	C	KÓD
nikl broušený	34	8,5	20,6	365354



CLEO GRANDE

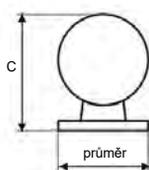

BAREVNÉ PROVEDENÍ	PRŮMĚR	C	KÓD
chrom lesklý	25	32	047281
chrom satén	25	32	057039
nikl satén	25	32	047282

ELLIEN

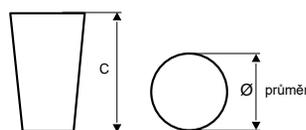

BAREVNÉ PROVEDENÍ	PRŮMĚR	C	KÓD
přírodní elox	20	25	512702

CLEO PICCOLO

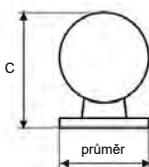

BAREVNÉ PROVEDENÍ	PRŮMĚR	C	KÓD
chrom lesklý	22	28	034698
chrom satén	22	28	103314
nikl satén	22	28	039627

GAIA

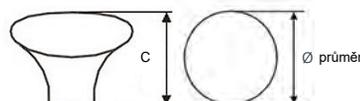

BAREVNÉ PROVEDENÍ	PRŮMĚR	C	KÓD
bílý porcelán	32	23	365366
krémový porcelán popraskaný	32	23	365367

dodání do 24 hodin dodání do 5 dní na objednávku / na dotaz

7.3 KNOPKY

7 ÚCHYTKY, VĚŠÁKY A PROFILY

HOLY

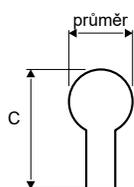

BAREVNÉ PROVEDENÍ	PRŮMĚR	C	KÓD
neroz	16	38	512701

INESA

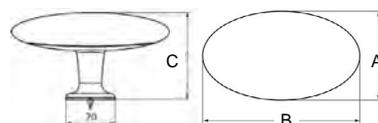

BAREVNÉ PROVEDENÍ	B	A	C	KÓD
antik ocel efekt	64	36	35	012009
antracit lesklý	64	36	35	750143
černá mat	64	36	35	787856
měď broušná	64	36	35	012008
rez efekt	64	36	35	709278
ušlechtilá ocel mat	64	36	35	661931
železo černé patina	64	36	35	787857

JACOB

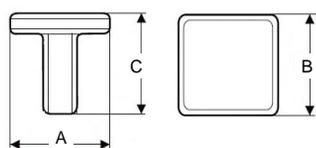

BAREVNÉ PROVEDENÍ	B	A	C	KÓD
chrom lesklý	40	40	24	511372
nikl broušený	40	40	24	511371

KELLI

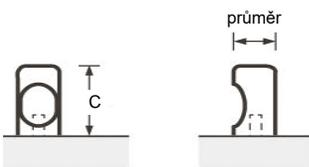

BAREVNÉ PROVEDENÍ	PRŮMĚR	C	KÓD
neroz broušený	18	25	512703

LAURA

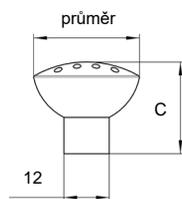

Knopku LAURA můžete použít spolu s úchytkou LAURA, GABRIELA a věšákem MARCO.

BAREVNÉ PROVEDENÍ	PRŮMĚR	C	KÓD
chrom lesklý	28	24	011667
chrom satén	28	24	011631
nikl matný	28	24	011651



LAVIDA

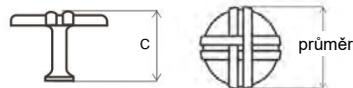

Knopku LAVIDA můžete použít spolu s úchytkou LAVIDA.

BAREVNÉ PROVEDENÍ	PRŮMĚR	C	KÓD
zlatá antik	33	28	680479



7.3 KNOPKY

7 ÚCHYTKY, VĚŠÁKY A PROFILY

LENNY

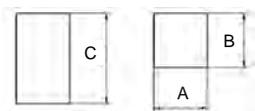

Knopku LENNY můžete použít spolu s úchytkou LENNY.

BAREVNÉ PŘÍRODNÍ	B	A	C	KÓD
přírodní elox	12	12	22	710493



LIBRA

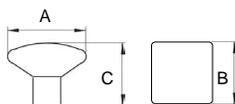

Knopku LIBRA můžete použít spolu s úchytkou LIBRA.

BAREVNÉ PŘÍRODNÍ	B	A	C	KÓD
chrom matný	20	20	24	011431
nikl jemně broušený	20	20	24	011430
nikl matný	20	20	24	011619



LIMA

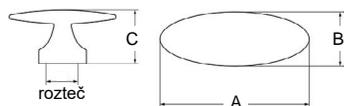

Knopku LIMA můžete použít spolu s úchytkou LIMA.

BAREVNÉ PŘÍRODNÍ	ROZTEČ	B	A	C	KÓD
antracit lesklý	16	56	20	28	787858
nikl jemně broušený	16	56	20	28	785943
železo broušené	16	56	20	28	751881

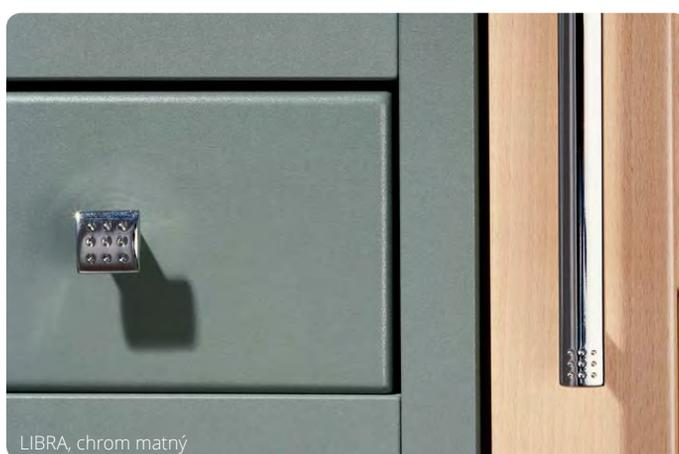

LIBRA, chrom matný

MARILIN

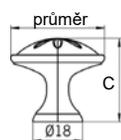

Knopku MARILIN můžete použít spolu s úchytkou MARILIN.

BAREVNÉ PŘÍRODNÍ	PRŮMĚR	C	KÓD
staromosaz brnír/plast béžový	34	30	185948
zinek/plast bílý	34	30	515862



LIMA, nikl jemně broušený

MESSANA

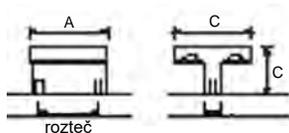

BAREVNÉ PŘÍRODNÍ	ROZTEČ	B	A	C	KÓD
chrom lesklý	32	8	42	28	160745
nerez finiš	32	8	42	28	159930

NOEMI

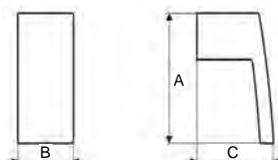

Knopku NOEMI můžete použít spolu s úchytkou NOEMI.

BAREVNÉ PŘÍRODNÍ	B	A	C	KÓD
chrom lesklý	20	47	28	511015
chrom satén	20	47	28	511017
nikl satén	20	47	28	511016



7.3 KNOPKY

7 ÚCHYTKY, VĚŠÁKY A PROFILY

OLIVIA



NÁŠ TIP Knopku OLIVIA můžete použít spolu s úchytkou RADOS.

BAREVNÉ PŘÍKRYTÍ	ROZTEČ	B	A	C	KÓD
hliník	32	80	8	34	344232
chrom lesklý	32	80	8	34	344233
imitace nerez	32	80	8	34	344234

OLVIA



NÁŠ TIP Knopku OLVIA můžete použít spolu s úchytkou OLVIA.

BAREVNÉ PŘÍKRYTÍ	ROZMĚR	C	KÓD
zlatá antik/porcelán popraskaný	60x30	28	680429

ORA

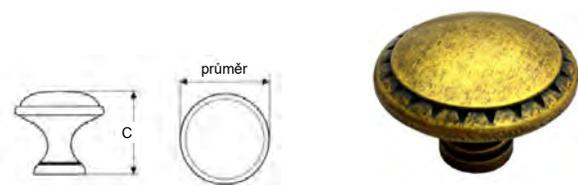

BAREVNÉ PŘÍKRYTÍ	PRŮMĚR	C	KÓD
zlatá antik	35	25	680436



ZAIRA, mosaz ručně broušená

QUADROS



NÁŠ TIP Knopku QUADROS můžete použít spolu s úchytkou RADOS.

BAREVNÉ PŘÍKRYTÍ	ROZTEČ	B	A	C	KÓD
hliník	32	45	8	30	344281
chrom lesklý	32	45	8	30	344282
imitace nerez	32	45	8	30	344283

SÁVA

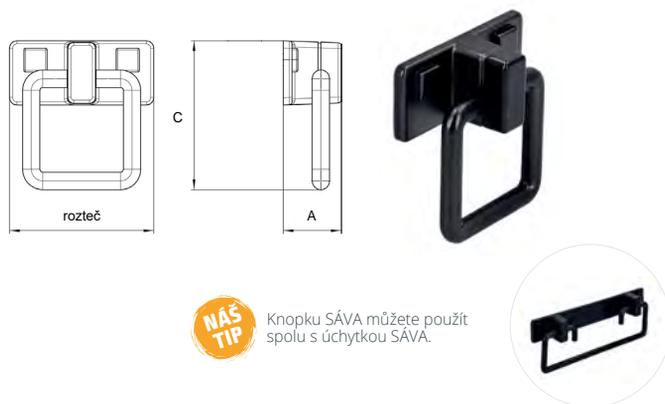

NÁŠ TIP Knopku SÁVA můžete použít spolu s úchytkou SÁVA.

BAREVNÉ PŘÍKRYTÍ	B	A	C	KÓD
černá mat	51	50	20	787850



SÁVA, černá mat

SERENA

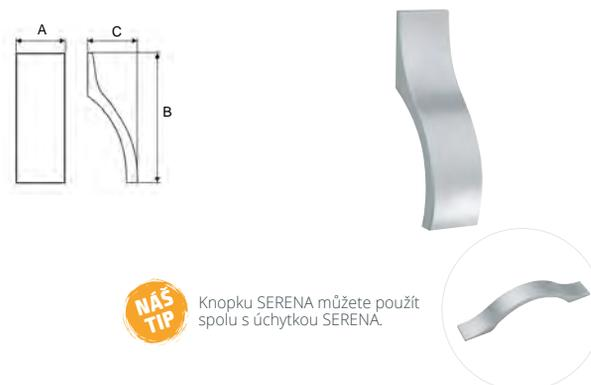

NÁŠ TIP Knopku SERENA můžete použít spolu s úchytkou SERENA.

BAREVNÉ PŘÍKRYTÍ	B	A	C	KÓD
nikl broušený	70	20	20	365444
chrom satén	70	20	20	365445

7.3 KNOPKY

7 ÚCHYTKY, VĚŠÁKY A PROFILY

SIMON

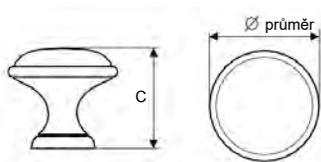

NÁŠ TIP

Knopku SIMON můžete použít spolu s úchytkou GRETA.



BAREVNÉ PROVEDENÍ	PRŮMĚR	C	KÓD
staromosaz/popraskaný porcelán krémový	29	24	365356

SPARTA

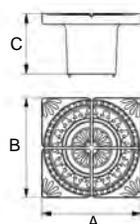

NÁŠ TIP

Knopku SPARTA můžete použít spolu s úchytkou a věšákem SPARTA.



BAREVNÉ PROVEDENÍ	B	A	C	KÓD
mosaz patina	38	38	23	376858
nikl patina	38	38	23	376857

TOSCA

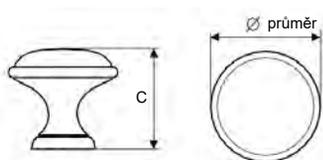

NÁŠ TIP

Knopku SIMON můžete použít spolu s úchytkou GRETA.



BAREVNÉ PROVEDENÍ	PRŮMĚR	C	KÓD
nikl patina/porcelán	30	25	680450
nikl patina/popraskaný porcelán	30	25	680452
nikl patina/porcelán s kvítkem	30	25	680453
nikl patina/porcelán s lístkem	30	25	680451

VESNA

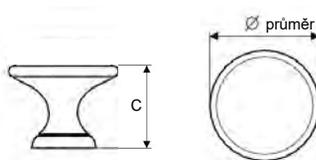

NÁŠ TIP

Knopku VESNA můžete použít spolu s úchytkou VESNA.



BAREVNÉ PROVEDENÍ	PRŮMĚR	C	KÓD
staromosaz kartáčovaná	30	24	352669

VIANA

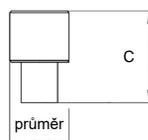

NÁŠ TIP

Knopku VIANA můžete použít spolu s úchytkou a věšákem VIANA.



BAREVNÉ PROVEDENÍ	PRŮMĚR	C	KÓD
černá mat	16	25	784090
ušlechtilá ocel mat	16	25	787862



VILANA, starostříbro/plast bílý

VILANA

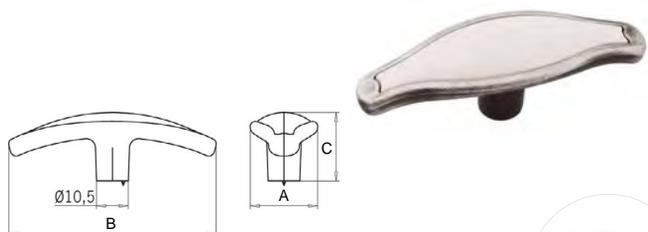

NÁŠ TIP

Knopku VILANA můžete použít spolu s úchytkou VILANA.



BAREVNÉ PROVEDENÍ	B	A	C	KÓD
staromosaz brnír/plast béžový	67	22	22	148859
starostříbro/plast bílý	67	22	22	746953

ZAIRA

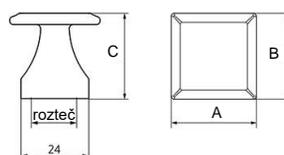

NÁŠ TIP

Knopku ZAIRA můžete použít spolu s úchytkou a věšákem ZAIRA.



BAREVNÉ PROVEDENÍ	ROZTEČ	B	A	C	KÓD
čínová	16	32	32	30	787863
mosaz ručně broušená	16	32	32	30	779929
železo černé patina	16	32	32	30	771094

■ dodání do 24 hodin
 ■ dodání do 5 dní
 ■ na objednávku / na dotaz

7.4 DŘEVĚNÉ ÚCHYTKY

7 ÚCHYTKY, VĚŠÁKY A PROFILY

DŘEVĚNÉ ÚCHYTKY

ARVIKA

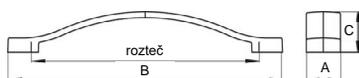

BAREVNÉ PROVEDENÍ	ROZTEČ	B	A	C	KÓD
buk	160	193	24	28	754601
dub	160	193	24	28	754600
jasan	160	193	24	28	754602

DRIVA

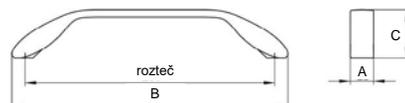

BAREVNÉ PROVEDENÍ	ROZTEČ	B	A	C	KÓD
buk	160	177	15	30	754604
dub	160	177	15	30	754603
jasan	160	177	15	30	754605

HALSA

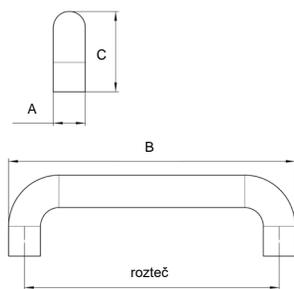

BAREVNÉ PROVEDENÍ	ROZTEČ	B	A	C	KÓD
borovice	64	76	12	30	805184
	96	112	16	32	802138
borovice lakovaná	64	76	12	30	805184
	96	112	16	32	802139
jasan surový	64	76	12	30	802140
	96	112	16	32	802137

MUŠLE

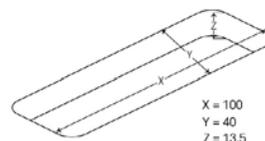
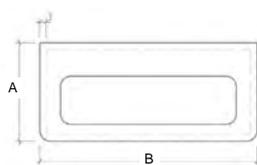

> zádlab d x š x h: 100 x 40 x 13,5 mm

BAREVNÉ PROVEDENÍ	B	A	C	KÓD
buk	105	47	19	011904
dub	105	47	19	011914

VALERIO

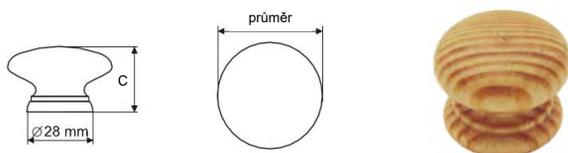

BAREVNÉ PROVEDENÍ	PRŮMĚR	C	KÓD
borovice	35	27	365369
buk	35	27	365368
olše	35	27	365370



DRIVA, dub

KOŽENÉ A JINÉ ÚCHYTKY

DALAS

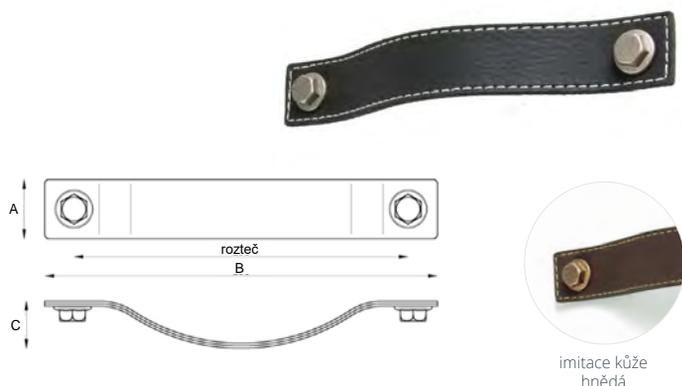

BAREVNÉ PŘÍKRYTÍ	ROZTEČ	B	A	C	KÓD
imitace kůže černá	160	188	28	23	787864
imitace kůže hnědá	160	188	28	23	787865

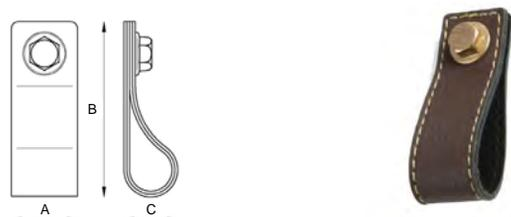

BAREVNÉ PŘÍKRYTÍ	B	A	C	KÓD
imitace kůže černá	74	28	23	787854
imitace kůže hnědá	74	28	23	787855

SANTIAGO

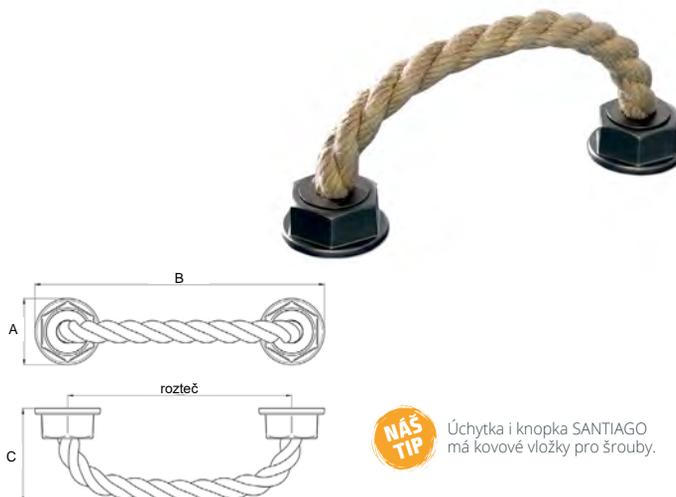

NAŠ TIP Úchytka i knopka SANTIAGO má kovové vložky pro šrouby.

BAREVNÉ PŘÍKRYTÍ	ROZTEČ	B	A	C	KÓD
provazová úchytka	optimálně 64	101	37	50	793135
plastová s flexibilní roztečí	optimálně 128	165	37	50	721488



BAREVNÉ PŘÍKRYTÍ	PRŮMĚR	C	KÓD
provazová knopka plastová	37	64	754607

TEXAS

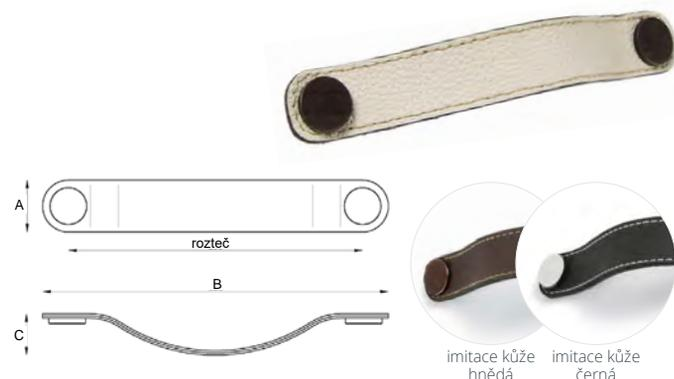

BAREVNÉ PŘÍKRYTÍ	ROZTEČ	B	A	C	KÓD
imitace kůže béžová	160	188	28	23	787888
imitace kůže černá	160	188	28	23	787889
imitace kůže hnědá	160	188	28	23	787890

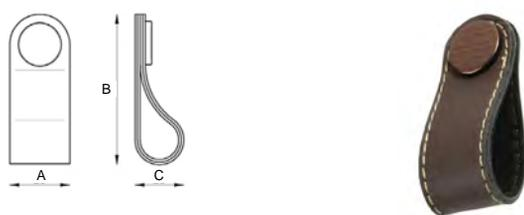

BAREVNÉ PŘÍKRYTÍ	B	A	C	KÓD
imitace kůže béžová	70	28	23	787859
imitace kůže černá	70	28	23	787860
imitace kůže hnědá	70	28	23	787861



SANTIAGO, provazová úchytka

ZÁPUSTNÉ ÚCHYTKY

ADRIANA

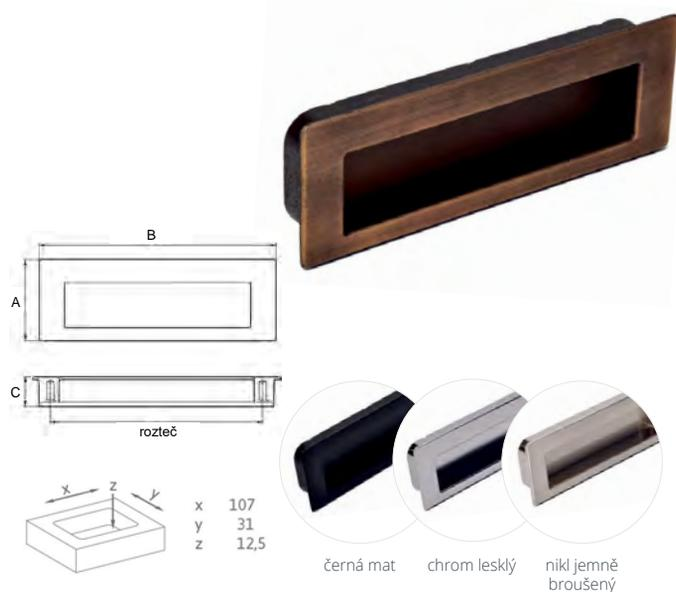

> zádlab d x š x h: 107 x 31 x 12,5 mm

BAREVNÉ PŘÍKRYTÍ	ROZTEČ	B	A	C	KÓD
černá mat	96	112	38	16	753996
chrom lesklý	96	112	38	16	787907
mosaz ručně broušený	96	112	38	16	750435
nikl jemně broušený	96	112	38	16	763765
železo broušené	96	112	38	16	751887



ADRIANA, železo broušené

INNA

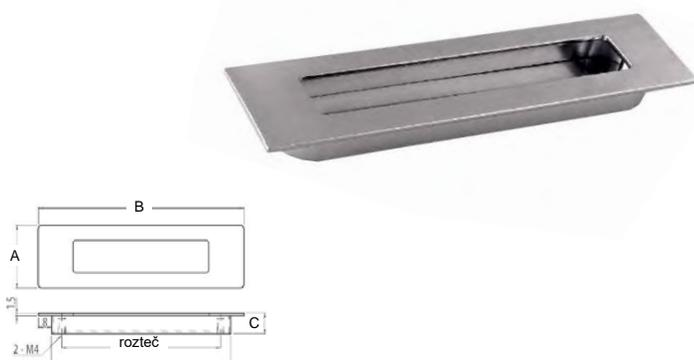

BAREVNÉ PŘÍKRYTÍ	ROZTEČ	B	A	C	KÓD
chrom	96	124	37,5	12,3	569794
	160	186	37,5	12,3	569796
nikl broušený	96	124	37,5	12,3	569795
	160	186	37,5	12,3	569797

ATHENA

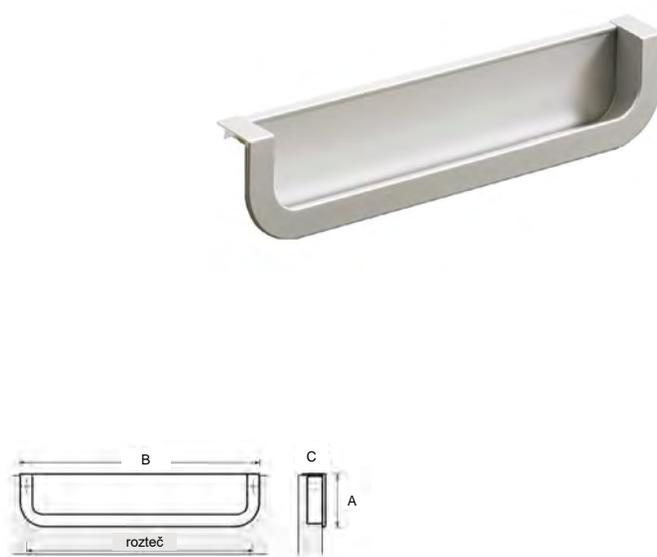

BAREVNÉ PŘÍKRYTÍ	ROZTEČ	B	A	C	KÓD
alu finiš	160	170	33	15	161098
chrom lesklý	160	170	33	15	161127
nerez finiš	160	170	33	15	161214

ENRICO

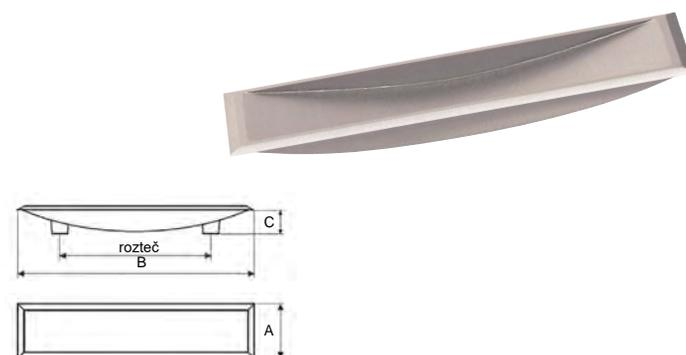

BAREVNÉ PŘÍKRYTÍ	ROZTEČ	B	A	C	KÓD
chrom satén	128	150	34	10	142728



ATHENA, nerez finiš

7.6 ZÁPUSTNÉ ÚCHYTKY

7 ÚCHYTKY, VĚŠÁKY A PROFILY

KATARINA

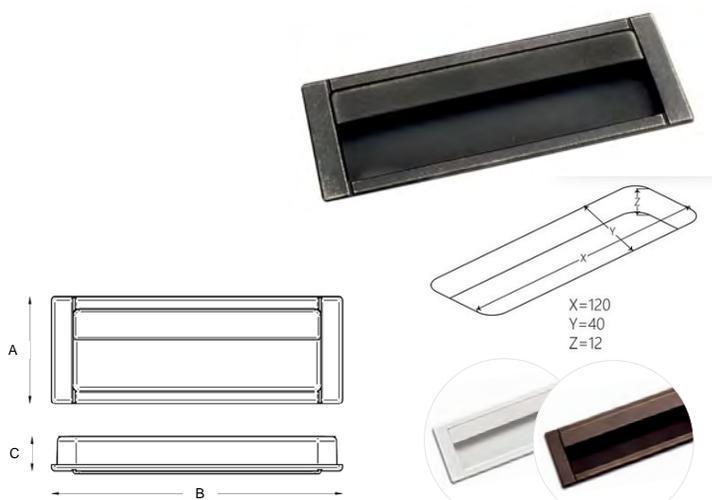

> základ d x š x h: 120 x 40 x 12 mm

bílá matná měď antik

BAREVNÉ PROVEDENÍ	B	A	C	KÓD
bílá matná	125	45	15	765885
měď antik	125	45	15	717541
stříbro antik	125	45	15	724127

MISNIA

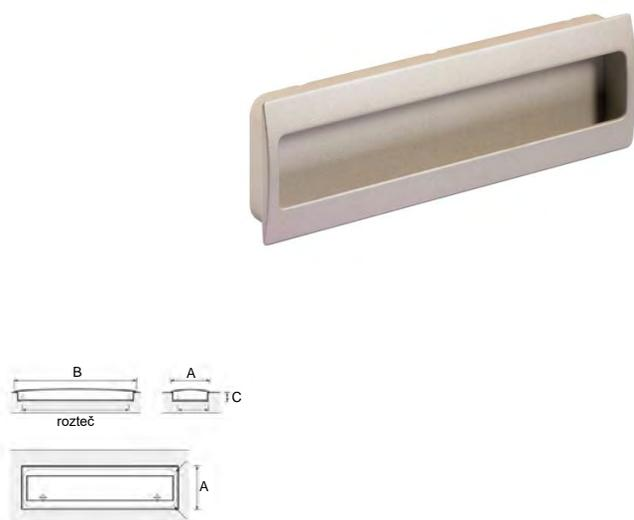

BAREVNÉ PROVEDENÍ	ROZTEČ	B	A	C	KÓD
hliník	96	116	54	14,5	036042
	160	180	54	14,5	161109
nikl satén	96	116	54	14,5	037246
	160	180	54	14,5	031099

MONICA II

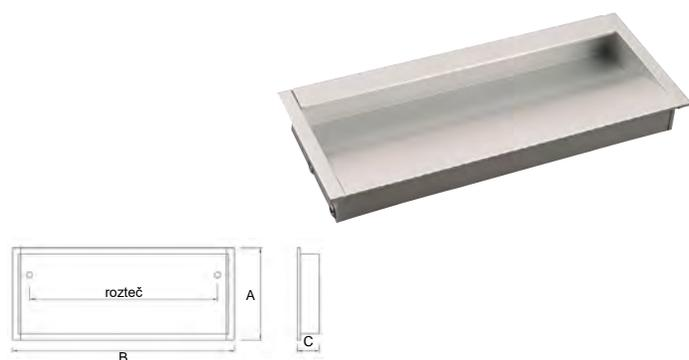

BAREVNÉ PROVEDENÍ	ROZTEČ	B	A	C	KÓD
hliník/chrom	128	141	43	16	344292
	160	173	43	16	344294
	224	237	43	16	344296
matný chrom/hliník	128	141	43	16	391030
	160	173	43	16	411568
	128	141	43	16	344293
nikl satén/imitace nerezí	160	173	43	16	344295
	224	237	43	16	344297

NIDUM

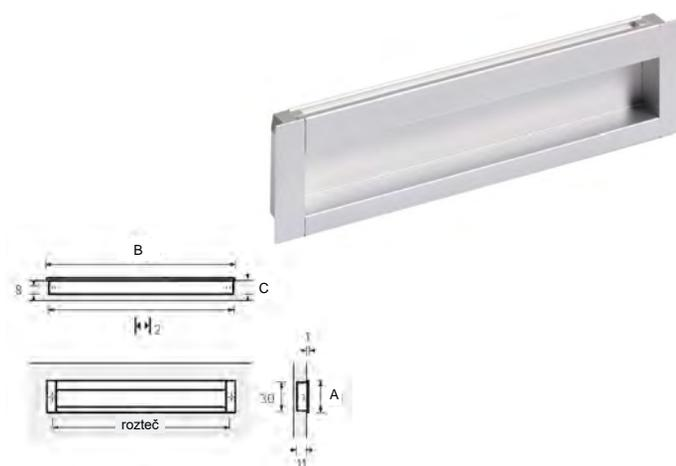

BAREVNÉ PROVEDENÍ	ROZTEČ	B	A	C	KÓD
elox-alu finiš	96	111	35	11	029808
	128	143	35	11	029809
	160	175	35	11	036056
	192	207	35	11	043448
	256	271	35	11	042671
	320	335	35	11	037603

NILA

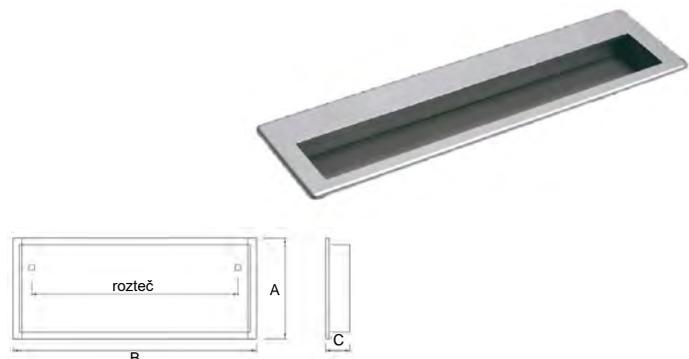

BAREVNÉ PROVEDENÍ	ROZTEČ	B	A	C	KÓD
chrom broušený	160	172	48	15,5	572876
nikl broušený	160	172	48	15,5	525624



■ dodání do 24 hodin ■ dodání do 5 dní ■ na objednávku / na dotaz

7.6 ZÁPUSTNÉ ÚCHYTKY 7 ÚCHYTKY, VĚŠÁKY A PROFILY

TOUCH-IN



> zádlab d x š: 179 x 44 mm

BAREVNÉ PROVEDENÍ	ROZTEČ	B	A	C	KÓD
nerez finiš	172	181	46	16	214918



VIKTORIE

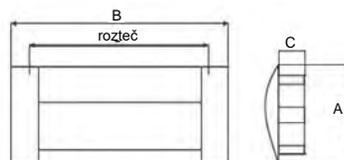

BAREVNÉ PROVEDENÍ	ROZTEČ	B	A	C	KÓD
chrom	96	110	45	12	031968
	128	142	45	12	122159
	160	174	45	12	581272
chrom satén	96	110	45	12	063592
	128	142	45	12	031967
	160	174	45	12	792693



7.7 VĚŠÁKY

7 ÚCHYTKY, VĚŠÁKY A PROFILY

VĚŠÁKY

ALTIS / NAVY

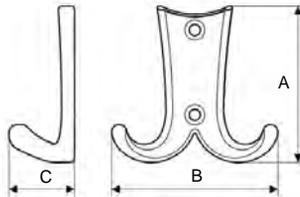
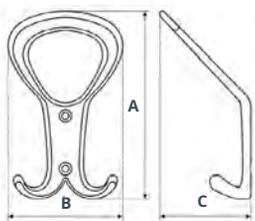

BAREVNÉ PROVEDENÍ	B	A	C	KÓD
chrom satén	70	113	55	492966
nikl leštěný	70	113	55	492961
nikl satén	70	113	55	492962

PROVEDENÍ / ROZMĚR (MM)	B	A	C	KÓD
chrom satén	63	59	25	492958
nikl leštěný	63	59	25	492959
nikl satén	63	59	25	492960

AYA

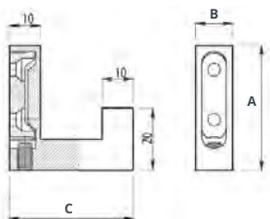

BAREVNÉ PROVEDENÍ	B	A	C	KÓD
chrom	12	40	40	512049
nikl broušený	12	40	40	512050

ANTONIO

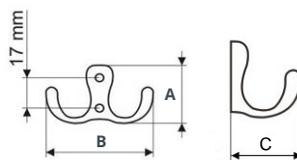

BAREVNÉ PROVEDENÍ	B	A	C	KÓD
černá	56	30	30	660661
chrom	56	30	30	012068
chrom satén	56	30	30	012070
mosaz	56	30	30	029027
nikl satén	56	30	30	012077

CORA

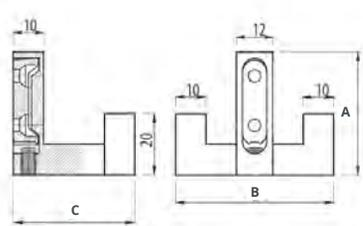

BAREVNÉ PROVEDENÍ	B	A	C	KÓD
chrom	52	40	40	512051
nikl broušený	52	40	40	512052

DAVID

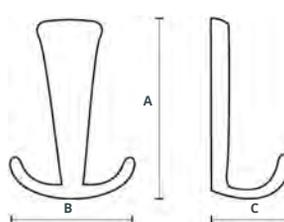

BAREVNÉ PROVEDENÍ	B	A	C	KÓD
chrom lesklý	74	113	32	377278
chrom satén	74	113	32	377273
nikl satén	74	113	32	377274

DAVÍDEK



BAREVNÉ PROVEDENÍ	B	A	C	KÓD
chrom lesklý	74	68	32	377275
chrom satén	74	68	32	377276
nikl satén	74	68	32	377277



FLINT, černá mat

■ dodání do 24 hodin ■ dodání do 5 dní ■ na objednávku / na dotaz

7.7 VĚŠÁKY

7 ÚCHYTKY, VĚŠÁKY A PROFILY

DENVER

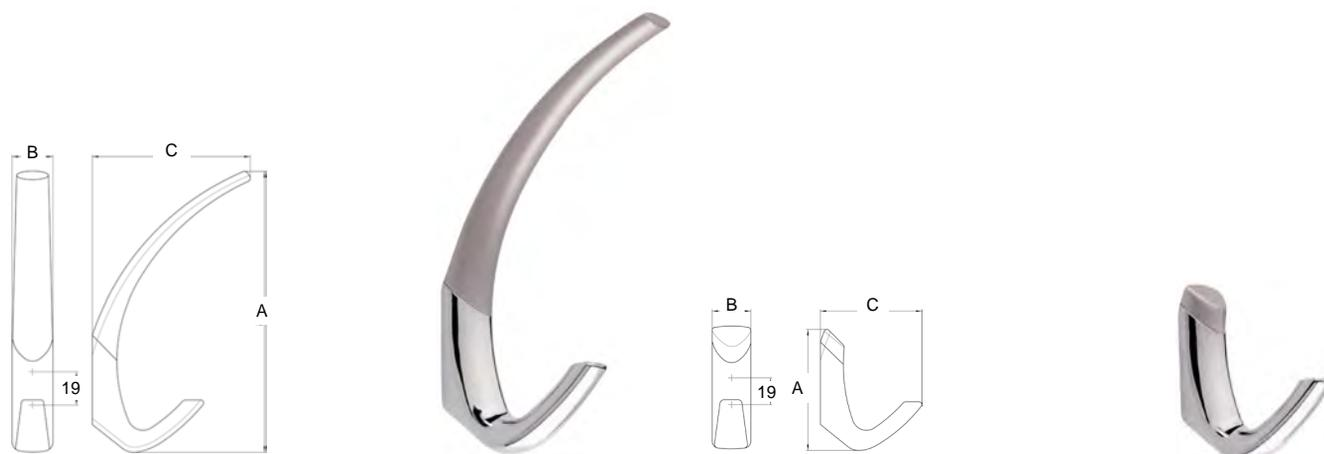

BAREVNÉ PŘEVODENÍ	B	A	C	KÓD
hliník/chrom lesk	24	160	90	802072

BAREVNÉ PŘEVODENÍ	B	A	C	KÓD
hliník/chrom lesk	24	73	64	802073

FABIO

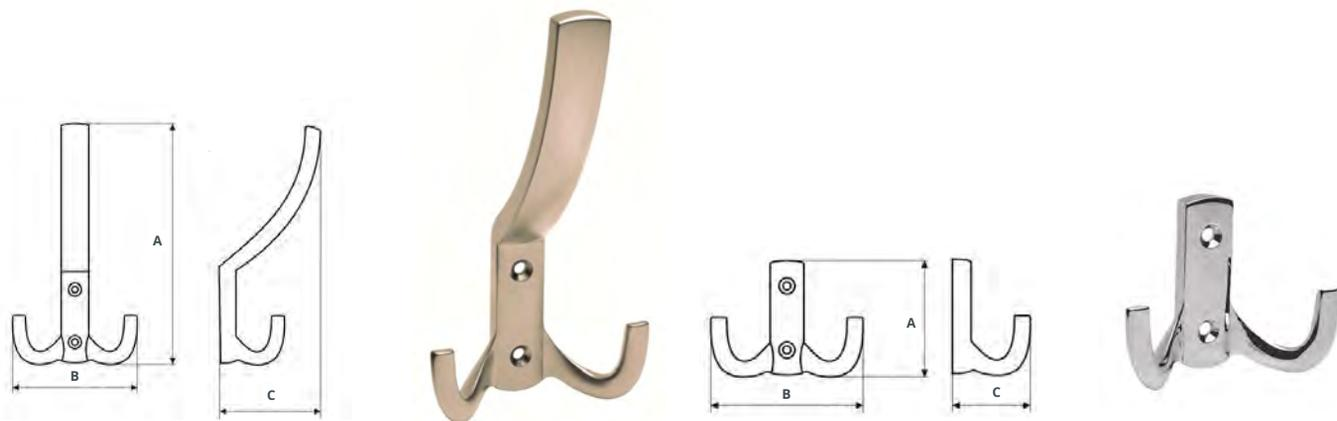

BAREVNÉ PŘEVODENÍ	B	A	C	KÓD
chrom	78	144	60	063669
chrom satén	78	144	60	063671
nikl broušený	78	144	60	794993
nikl satén	78	144	60	063670

BAREVNÉ PŘEVODENÍ	B	A	C	KÓD
chrom	78	58	30	063665
chrom satén	78	58	30	063667
nikl broušený	78	58	30	794994
nikl satén	78	58	30	063666

FLINT

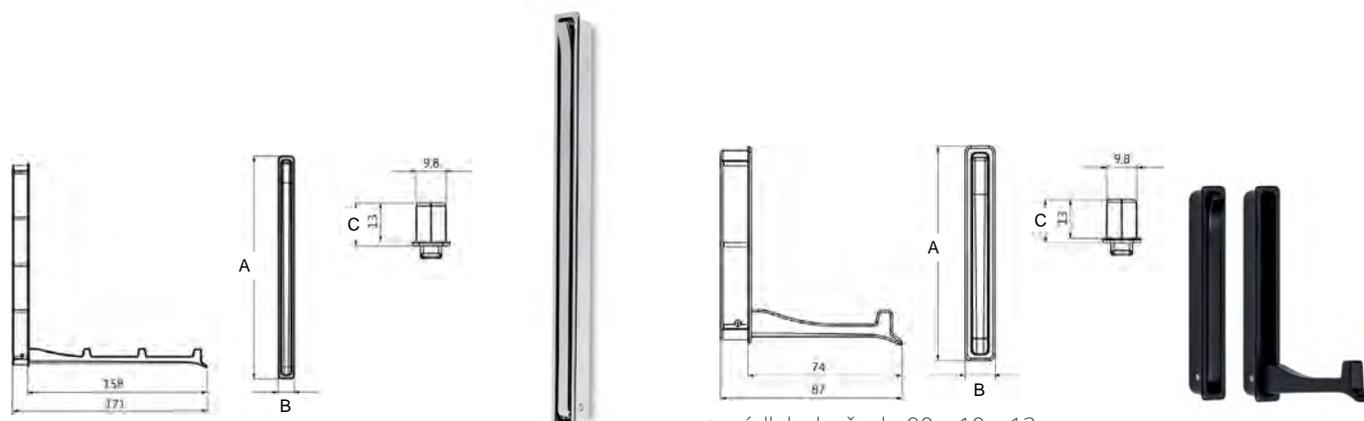

> základ d x š x h: 174 x 10 x 13 mm

BAREVNÉ PŘEVODENÍ	B	A	C	KÓD
chrom lesklý	13	177	14,5	664311
nikl jemně broušený	13	177	14,5	683318

> základ d x š x h: 90 x 10 x 13 mm

BAREVNÉ PŘEVODENÍ	B	A	C	KÓD
černá mat	13	93	14,5	787908
chrom lesklý	13	93	14,5	681577
nikl jemně broušený	13	93	14,5	683131

7.7 VĚŠÁKY

7 ÚCHYTKY, VĚŠÁKY A PROFILY

ISIS

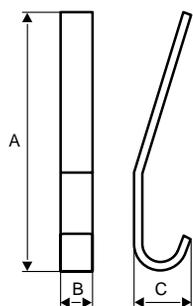

KANSAS, železo broušené

BAREVNÉ PROVEDENÍ	B	A	C	KÓD
přírodní elox	18	175	50	512707

KANSAS

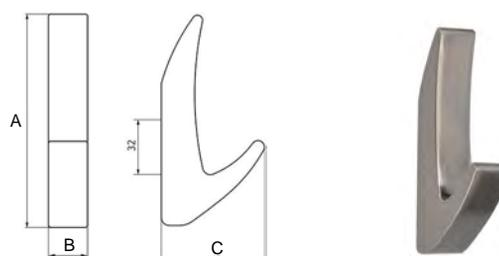
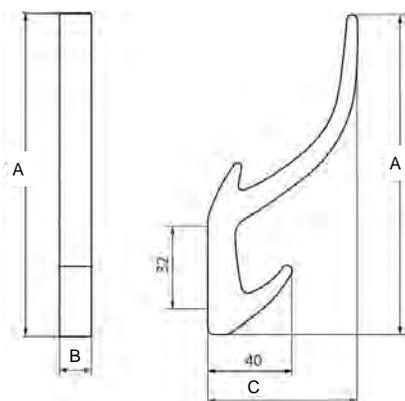

BAREVNÉ PROVEDENÍ	B	A	C	KÓD
černá mat	15	150	71	786678
chrom lesklý	15	150	71	754608
mosaz ručně broušená	15	150	71	750434
nikl jemně broušený	15	150	71	754609
starozlatá	15	150	71	787910
železo broušené	15	150	71	751892

BAREVNÉ PROVEDENÍ	B	A	C	KÓD
černá mat	15	81	40	786680
chrom lesklý	15	81	40	754610
mosaz ručně broušená	15	81	40	754612
nikl jemně broušený	15	81	40	751065
starozlatá	15	81	40	787909
železo broušené	15	81	40	754611

KITTY

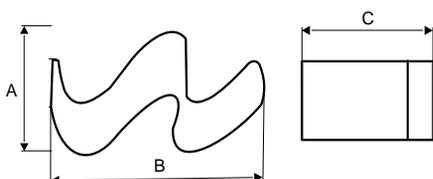

LIA

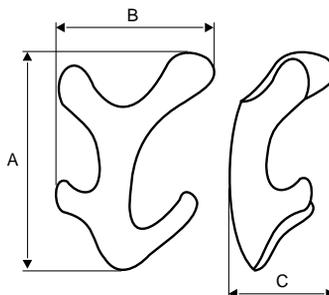

BAREVNÉ PROVEDENÍ	B	A	C	KÓD
nikl broušený	99,6	60,5	48,7	525619

BAREVNÉ PROVEDENÍ	B	A	C	KÓD
chrom satén	113	86,6	42,15	525620
nikl broušený	113	86,6	42,15	525621

■ dodání do 24 hodin
 ■ dodání do 5 dní
 ■ na objednávku / na dotaz

7.7 VĚŠÁKY

7 ÚCHYTKY, VĚŠÁKY A PROFILY

LIBRA

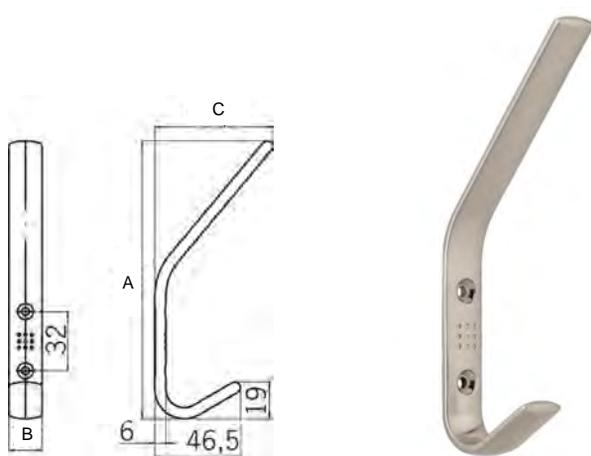

BAREVNÉ PROVEDENÍ	B	A	C	KÓD
nikl jemně broušený	18	150	63,5	095079
nikl matný	18	150	63,5	125379

NÁŠ TIP

Věšák LIBRA můžete použít spolu s úchytkami a knopkami LIBRA.

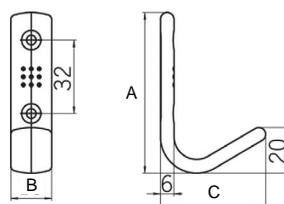

BAREVNÉ PROVEDENÍ	B	A	C	KÓD
nikl jemně broušený	18	70	46,5	095080
nikl matný	18	70	46,5	102688

LINA

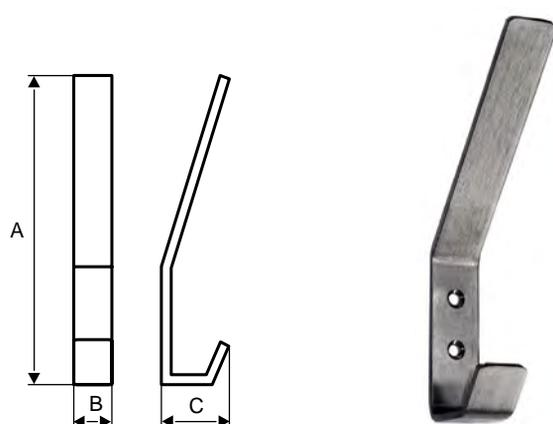

BAREVNÉ PROVEDENÍ	B	A	C	KÓD
nerez broušený	20	142	65	512705

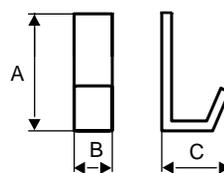

BAREVNÉ PROVEDENÍ	B	A	C	KÓD
nerez broušený	20	60	45	512706

LOUISIANA

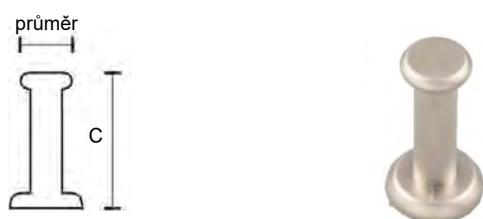

BAREVNÉ PROVEDENÍ	PRŮMĚR	C	KÓD
chrom lesklý	18	47	376854
chrom satén	18	47	376856
nikl satén	18	47	376855



PIETRO chrom satén

7.7 VĚŠÁKY

7 ÚCHYTKY, VĚŠÁKY A PROFILY

MARCO

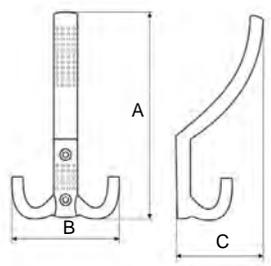

NÁŠ TIP

Věšák MARCO můžete použít spolu s úchytkami LAURA a GABRIELA.

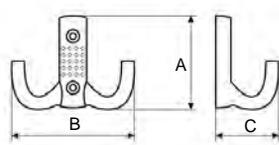

BAREVNÉ PŘÍMĚŠENÍ	B	A	C	KÓD
chrom lesklý	78	144	60	063645
chrom satén	78	144	60	063647
nikl satén	78	144	60	063646

BAREVNÉ PŘÍMĚŠENÍ	B	A	C	KÓD
chrom lesklý	78	58	30	063655
chrom satén	78	58	30	063663
nikl satén	78	58	30	063656

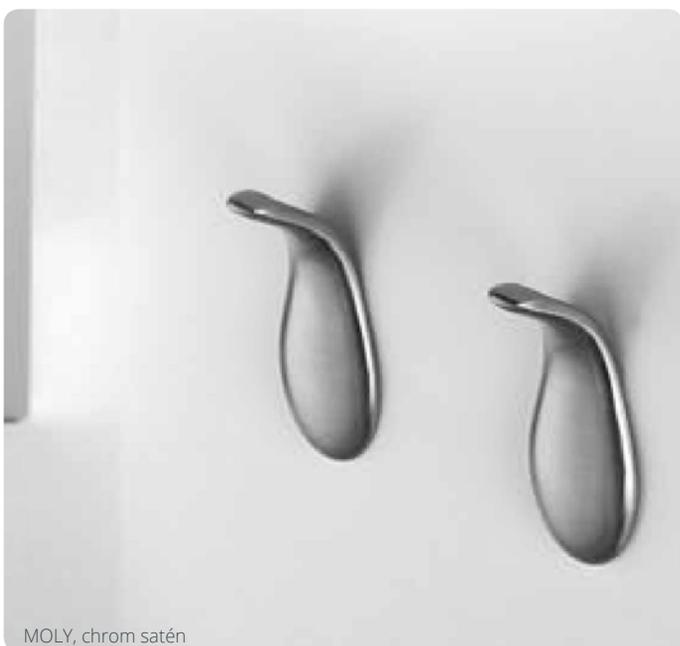

MOLY, chrom satén

MOLY

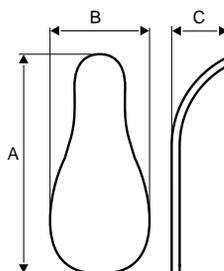

BAREVNÉ PŘÍMĚŠENÍ	B	A	C	KÓD
chrom lesklý	40	85,5	40	511618
chrom satén	40	85,5	40	511619
nikl broušený	40	85,5	40	511621
nikl satén	40	85,5	40	511620

NIA

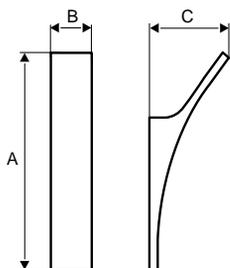

BAREVNÉ PŘÍMĚŠENÍ	B	A	C	KÓD
chrom	19	72	24	512053
nikl broušený	19	72	24	512054

PAOLO

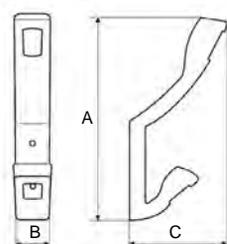

BAREVNÉ PŘÍMĚŠENÍ	B	A	C	KÓD
chrom	23	152	70	346320
chrom satén	23	152	70	135027
nikl leštěný	23	152	70	459293
nikl satén	23	152	70	042493

dodání do 24 hodin dodání do 5 dní na objednávku / na dotaz

7.7 VĚŠÁKY

7 ÚCHYTKY, VĚŠÁKY A PROFILY

PEDRO

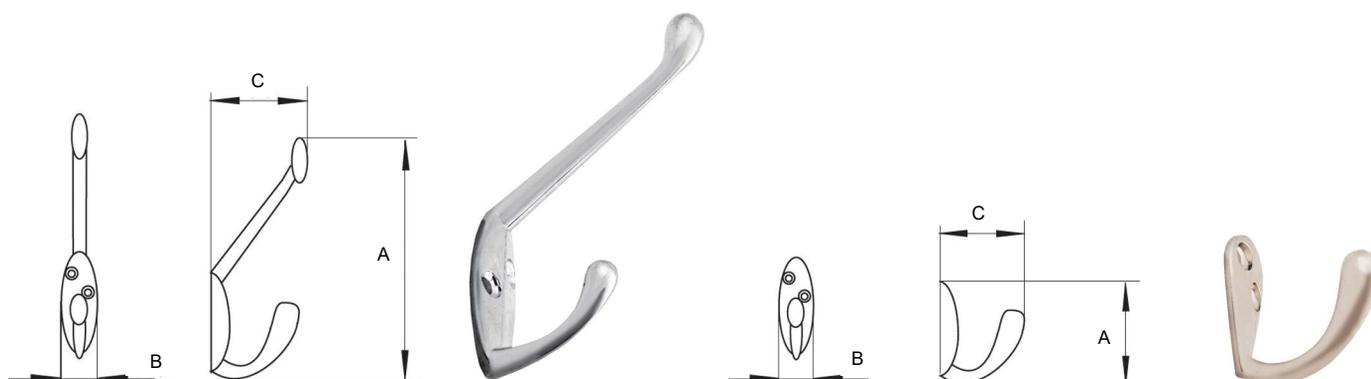

BAREVNÉ PŘÍKRYTÍ	B	A	C	KÓD
chrom lesklý	17,5	88	56	754613
nikl matný	17,5	88	56	497260

BAREVNÉ PŘÍKRYTÍ	B	A	C	KÓD
chrom lesklý	18	43	38	121266
nikl matný	18	43	38	417787

PIETRO

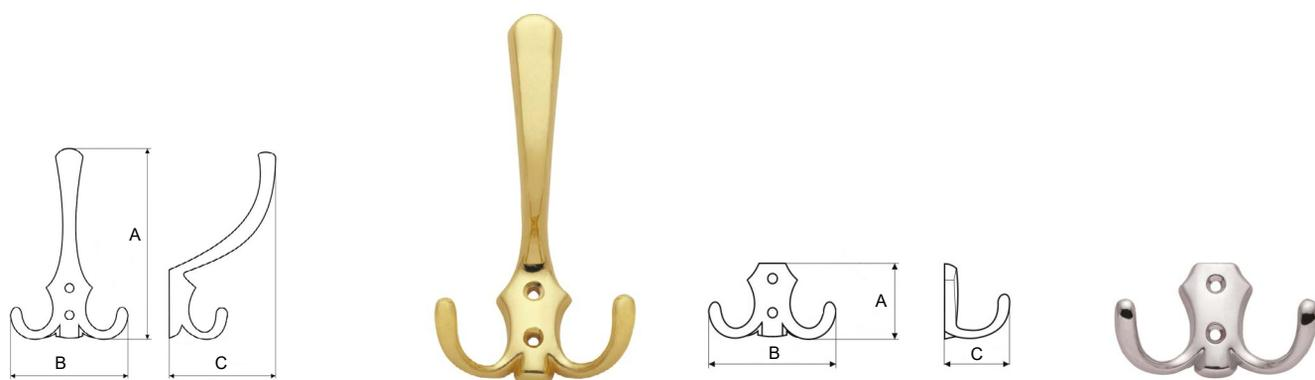

BAREVNÉ PŘÍKRYTÍ	B	A	C	KÓD
chrom	78	125	70	012099
chrom satén	78	125	70	063674
nikl satén	78	125	70	012026
staromosaz	78	125	70	012027

BAREVNÉ PŘÍKRYTÍ	B	A	C	KÓD
chrom	78	46	30	012022
chrom satén	78	46	30	063675
nikl satén	78	46	30	012023
staromosaz	78	46	30	012024

POLO

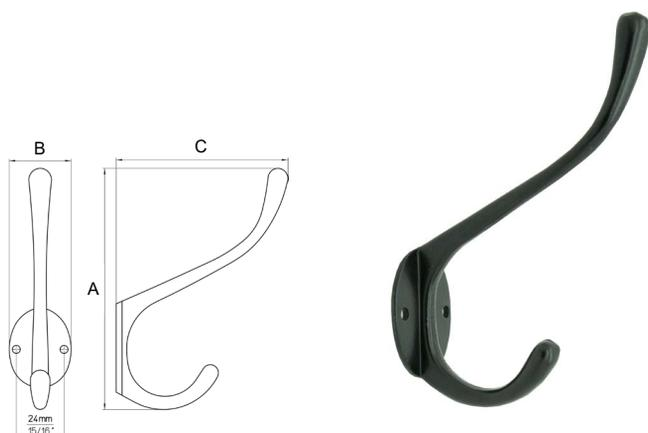

BAREVNÉ PŘÍKRYTÍ	B	A	C	KÓD
bílá lesklá				787933
černá matná				787934
hliník leštěný				787935

SONNY



BAREVNÉ PŘÍKRYTÍ	B	A	C	KÓD
chrom lesklý	80,5	109,25	30	511376
nikl broušený	80,5	109,25	30	511377
nikl satén	80,5	109,25	30	511378

7.7 VĚŠÁKY

7 ÚCHYTKY, VĚŠÁKY A PROFILY

TOLEDO

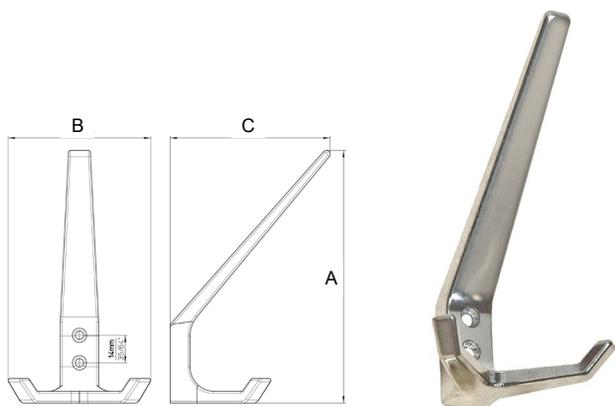

BAREVNÉ PŘÍKRYTÍ	B	A	C	KÓD
hliník lesklý	76	130	57	215815

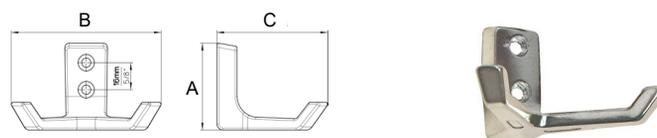

BAREVNÉ PŘÍKRYTÍ	B	A	C	KÓD
hliník lesklý	78	43	82,5	345154

TOMAS

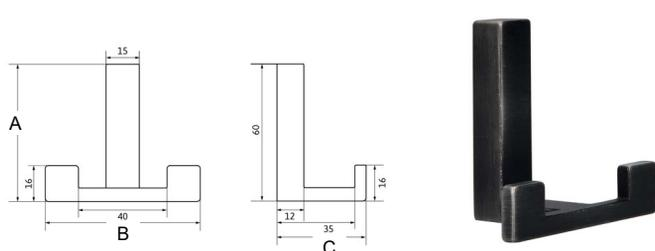

BAREVNÉ PŘÍKRYTÍ	B	A	C	KÓD
bílá lesklá	70	60	40	742426
černá mat	70	60	40	753279
chrom lesklý	70	60	40	642105
nikl jemně broušený	70	60	40	559840
železo broušené	70	60	40	718926

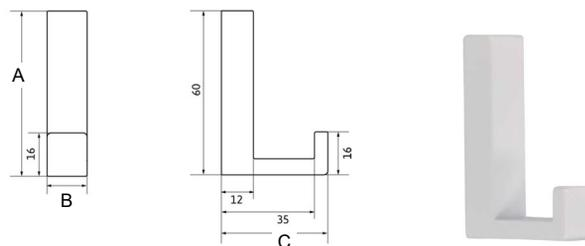

BAREVNÉ PŘÍKRYTÍ	B	A	C	KÓD
bílá lesklá	15	60	40	787911
černá mat	15	60	40	740137
chrom lesklý	15	60	40	633279
nikl jemně broušený	15	60	40	570824
železo broušené	15	60	40	752349

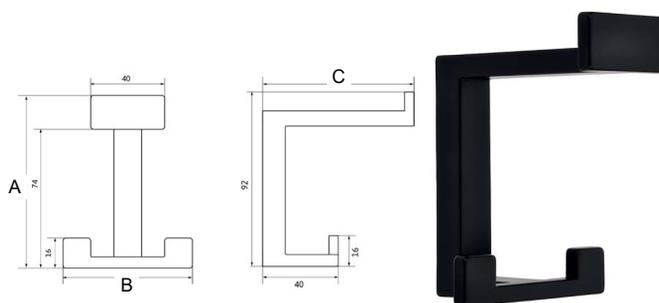

BAREVNÉ PŘÍKRYTÍ	B	A	C	KÓD
bílá lesklá	70	92	80	771030
černá mat	70	92	80	738080
chrom lesklý	70	92	80	572007
nikl jemně broušený	70	92	80	559814
železo broušené	70	92	80	711533

VIANA



Věšák VIANA můžete použít spolu s úchytkami a knopkami VIANA.

BAREVNÉ PŘÍKRYTÍ	B	A	C	KÓD
černá mat	26	34	40	787912
ušlechtilá ocel mat	26	34	40	787913



7.8 DĚTSKÉ A PLASTOVÉ ÚCHYTKY, KNOPKY A VĚŠÁKY

7 ÚCHYTKY, VĚŠÁKY A PROFILY

DĚTSKÉ A PLASTOVÉ ÚCHYTKY, KNOPKY A VĚŠÁKY

BELA

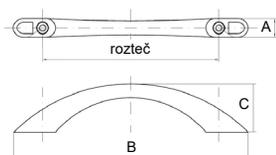

BAREVNÉ PROVEDENÍ	ROZTEČ	B	A	C	KÓD
modrá	96	129	10	25	364875
oranžová	96	129	10	25	364876
zelená	96	129	10	25	364877
žlutá	96	129	10	25	364874

BERRY

> knopka

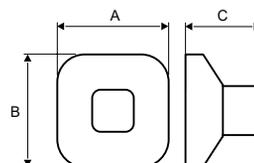
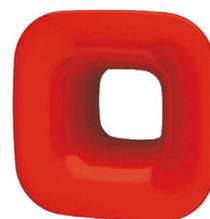

BAREVNÉ PROVEDENÍ	B	A	C	KÓD
červená	63	63	30	511624
zelená	63	63	30	511625

BIBI

> knopka

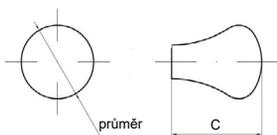

BAREVNÉ PROVEDENÍ	PRŮMĚR	C	KÓD
oranžová matná	22	28	364898
stříbrná matná	22	28	364897
zelená matná	22	28	364899

BRITA

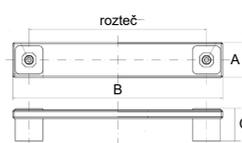

POVRCH	ROZTEČ	B	A	C	KÓD
červená hladká/stříbrná	128	150	25	24	364972
modrá hladká/stříbrná	128	150	25	24	364973

DIGI

> knopka

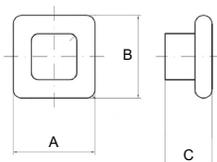

BAREVNÉ PROVEDENÍ	B	A	C	KÓD
červená matná/stříbrná	36	36	21	364905
červená poloprůsvitná/stříbrná	36	36	21	364907
světle modrá matná/stříbrná	36	36	21	364904
světle modrá poloprůsvitná/stříbrná	36	36	21	364906

BOLTA

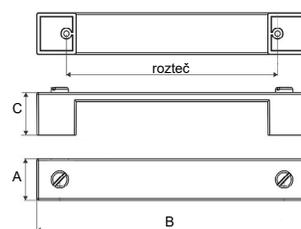

BAREVNÉ PROVEDENÍ	ROZTEČ	B	A	C	KÓD
stříbrno antik	128	164	25	25	787516

7.8 DĚTSKÉ A PLASTOVÉ ÚCHYTKY, KNOPKY A VĚŠÁKY

7 ÚCHYTKY, VĚŠÁKY A PROFILY

HVĚZDIČKA

> věšák

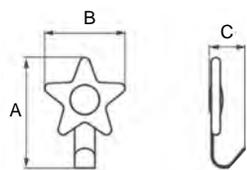

BAREVNÉ PROVEDENÍ	A	B	C	KÓD
modrá	100	77	30	692825
růžová	100	77	30	692824
žlutá	100	77	30	692823

JOLY

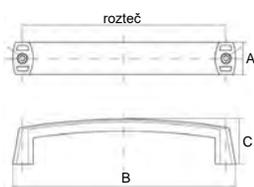

BAREVNÉ PROVEDENÍ	ROZTEČ	B	A	C	KÓD
hnědá	128	140	20	28	370770
modrá	128	140	20	28	364964
zelená	128	140	20	28	364965

JOY

> knopka

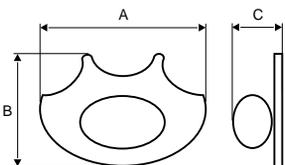

BAREVNÉ PROVEDENÍ	A	B	C	KÓD
oranžová/černá	70	55	30	511628
zelená/černá	70	55	30	511627

KNOFLÍK

> knopka

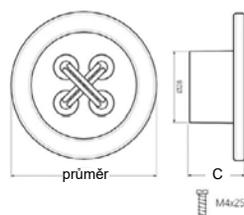

BAREVNÉ PROVEDENÍ	PRŮMĚR	C	KÓD
bílá	58	23	754606
modrá	58	23	751253
růžová	58	23	721063

KOČKA

> knopka

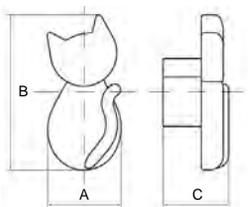

BAREVNÉ PROVEDENÍ	A	B	C	KÓD
červená	27	55	24	364895



KYTIČKA

> věšák

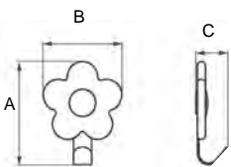

BAREVNÉ PROVEDENÍ	A	B	C	KÓD
růžová	100	77	30	692822
žlutá	100	77	30	692225

MEDVÍDEK

> věšák

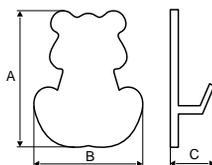

BAREVNÉ PROVEDENÍ	A	B	C	KÓD
oranžový	70	70	35	511623
zelený	70	70	35	511622

7.8 DĚTSKÉ A PLASTOVÉ ÚCHYTKY, KNOPKY A VĚŠÁKY

7 ÚCHYTKY, VĚŠÁKY A PROFILY

NOSOROŽEC

> věšák

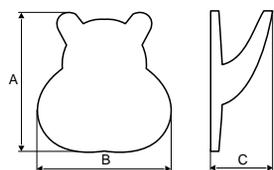

BAREVNÉ PROVEDENÍ	A	B	C	KÓD
červený	70	70	35	525623
zelený	70	70	35	525622

PIGI

> knopka

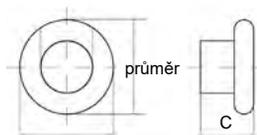

BAREVNÉ PROVEDENÍ	PRŮMĚR	C	KÓD
červená matná/stříbrná	36	21	364901
světle modrá matná/stříbrná	36	21	364900

PUMBA

> knopka

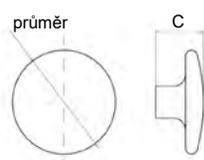

BAREVNÉ PROVEDENÍ	PRŮMĚR	C	KÓD
oranžová	52	24	364892
pistáciová	52	24	364894

PUPA

> knopka

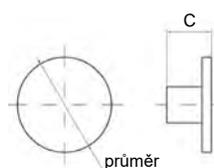

BAREVNÉ PROVEDENÍ	PRŮMĚR	C	KÓD
modrá	40	19	364969
oranžová	40	19	365423
pistáciová	40	19	364970
stříbrná	40	19	364966
zelená	40	19	364968
žlutá	40	19	364967

RELY

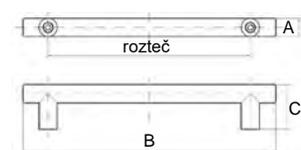

BAREVNÉ PROVEDENÍ	ROZTEČ	B	A	C	KÓD
modrá	128	160	11	28	364959
zelená	128	160	11	28	364960
žlutá	128	160	11	28	364958



VERA

> knopka

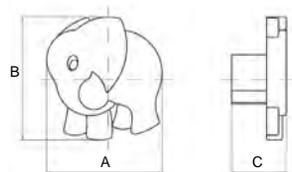

BAREVNÉ PROVEDENÍ	A	B	C	KÓD
modrá	52	55	25	364896

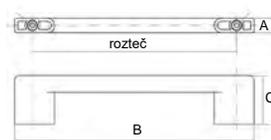

BAREVNÉ PROVEDENÍ	ROZTEČ	B	A	C	KÓD
červená	128	150	9	29	364879
	160	200	10	30	364882
	128	150	9	29	364878
fialová	160	200	10	30	364881
	228	317	12	34	364884
	128	150	9	29	364880
pistáciová	160	200	10	30	364883
	228	317	12	34	364886

PROFILOVÉ ÚCHYTKY

LAMEZIA

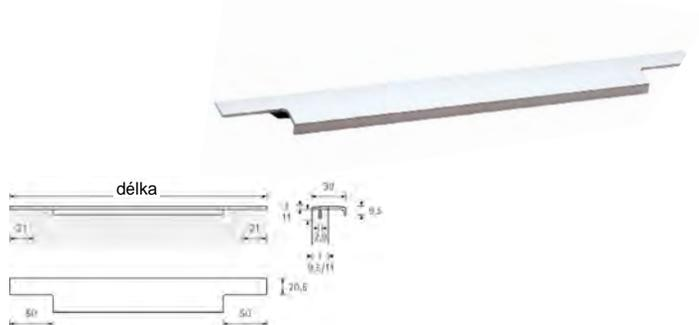

BAREVNÉ PROVEDENÍ	DĚLKA	KÓD
chrom lesklý	295	317360
	345	317361
	395	317362
	445	317363
	495	317364
	595	317365
	795	317366
nerez broušená	895	317367
	995	317368
	1 195	317369
	295	317370
	345	317371
	395	317372
	445	317373
nerez broušená	495	317374
	595	317375
	795	317376
	895	317377
	995	317378
	1 195	317379



SIMIA



BAREVNÉ PROVEDENÍ	DĚLKA	KÓD
černá mat	245	794933
	295	794935
	345	794937
	395	794939
	445	794941
	495	794943
	545	794945
	595	794947
	695	794949
	795	794951
nerezová ocel efekt	895	794953
	995	794955
	1 095	794957
	1 195	794959
	245	794932
	295	794934
	345	794936
	395	794938
	445	794940
	495	794942
545	794944	
595	794946	
695	794948	
795	794950	
895	794952	
995	794954	
1 095	794956	
1 195	794958	

THEA

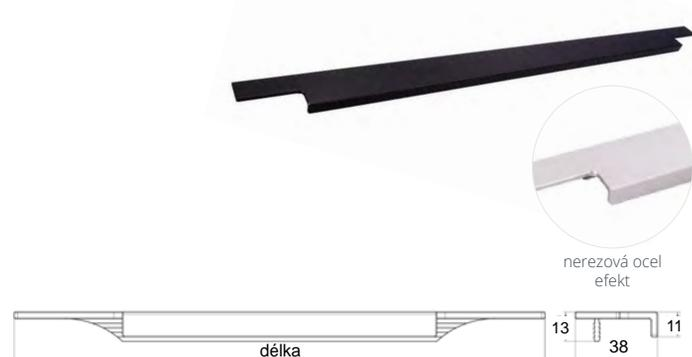

BAREVNÉ PROVEDENÍ	DĚLKA	KÓD
černá mat	295	802158
	395	802159
	495	802160
	595	802162
	695	802129
	795	802163
	895	802165
nerezová ocel efekt	995	802167
	295	802157
	395	789917
	495	789918
	595	802161
	695	802128
	795	789920
nerezová ocel efekt	895	802164
	995	802166



PROFILOVÉ ÚCHYTKY

Profilové úchytky jsou velmi oblíbené pro svou čistou linii. Úchytky se montují **naražením do hrany dveřík** do předem vyfrézované drážky.

V naší nabídce naleznete již **hotové úchytky s přesným rozměrem v délkách od 196 do 1 196 mm a s odřezaným stromečkem** k naražení do dveřík, případně s odřezovaným úchytem s přesně definovaným rádiusem vybrání úchyty. **Profilové úchytky lze rovněž připravit na míru** v libovolné délce až 6 m.



lakování
RAL

Všechny profilové úchytky lze lakovat do libovolné barvy dle dostupného RAL vzorníku.



lakování
IGP

V rámci lakování nabízíme rovněž **vysoce odolný povrch IGP v černé barvě**. Tato barva vyniká stálostí barvy, odolností vůči UV záření a je rovněž ořezu odolná.

UK 2

- > materiál hliník
- > barva hliník, černá mat



lakování
RAL



lakování
IGP

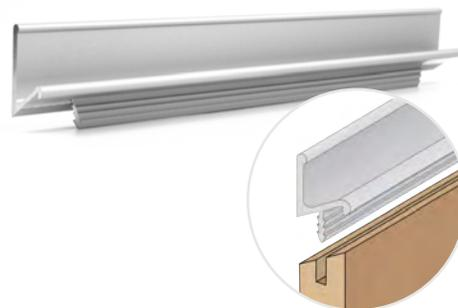
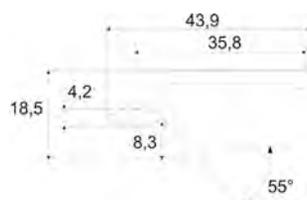

BARVA / DÉLKA (MM)	196	246	296	346	396	446	496	546	596	696	796	896	996	1 196
hliník	793648	793649	793650	793651	793652	793653	793654	793655	793656	793657	793658	793659	793660	793661
černá mat	793662	793663	793664	793665	793666	793667	793668	793669	793670	793671	793672	793673	793674	793675

UK 4

- > materiál hliník
- > barva hliník, černá mat



lakování
RAL



lakování
IGP

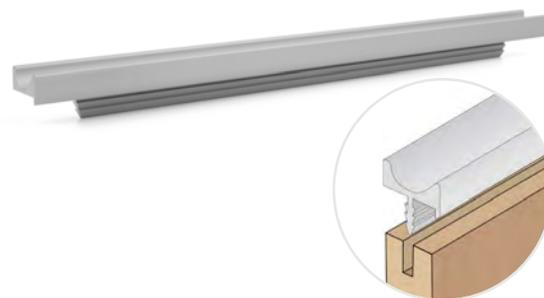
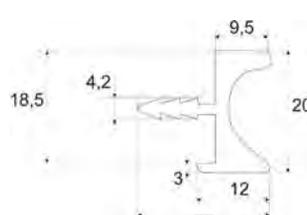

BARVA / DÉLKA (MM)	196	246	296	346	396	446	496	546	596	696	796	896	996	1 196
hliník	793676	793677	793678	793679	793680	793681	793682	793683	793684	793685	793686	793687	793688	793689
černá mat	793690	793691	793692	793693	793694	793695	793696	793697	793698	793699	793700	793701	793702	793703

UK 5

- > materiál hliník
- > barva hliník, nerez, černá mat



lakování
RAL



lakování
IGP

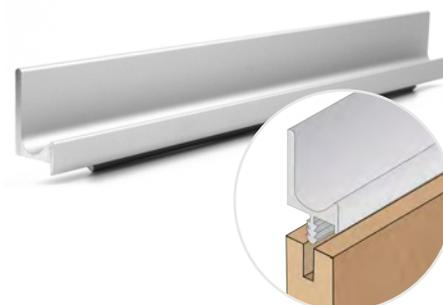
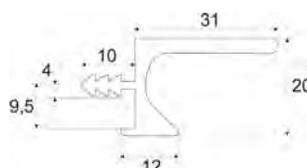

BARVA / DÉLKA (MM)	196	246	296	346	396	446	496	546	596	696	796	896	996	1 196
hliník	793704	793705	793706	793707	793708	793709	793710	793711	793712	793713	793714	793715	793716	793717
nerez	793718	793719	793720	793721	793722	793723	793724	793725	793726	793727	793728	793729	793730	793731
černá mat	793732	793733	793734	793735	793736	793737	793738	793739	793740	793741	793742	793743	793744	793745

UK 6

- > materiál hliník
- > barva hliník, černá mat

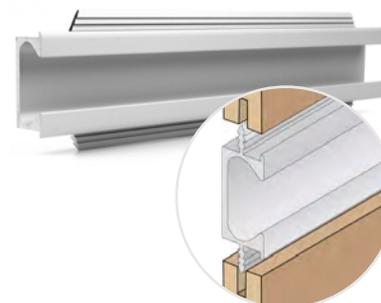
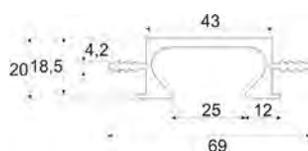
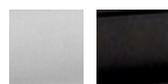

BARVA / DÉLKA (MM)	196	246	296	346	396	446	496	546	596	696	796	896	996	1 196
hliník	793746	793747	793748	793749	793750	793751	793752	793753	793754	793755	793756	793757	793758	793759
černá mat	793760	793761	793762	793763	793764	793765	793766	793767	793768	793769	793770	793771	793772	793773

UK 7

- > materiál hliník
- > barva hliník, nerez, nerez lakovaný, černá

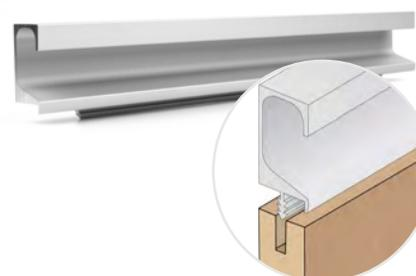
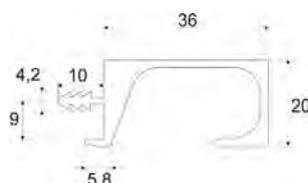

BARVA / DÉLKA (MM)	196	246	296	346	396	446	496	546	596	696	796	896	996	1 196
hliník	793774	793775	793776	793777	793778	793779	793780	793781	793782	793783	793784	793785	793786	793787
nerez	793788	793789	793790	793791	793792	793793	793794	793795	793796	793797	793798	793799	793800	793801
nerez lakovaný	793802	793803	793804	793805	793806	793807	793808	793809	793810	793811	793812	793813	793814	793815
černá	793816	793817	793818	793819	793820	793821	793822	793823	793824	793825	793826	793827	793828	793829

UK 8

- > materiál hliník
- > barva hliník, světlý nerez, tmavý nerez, chrom, černá

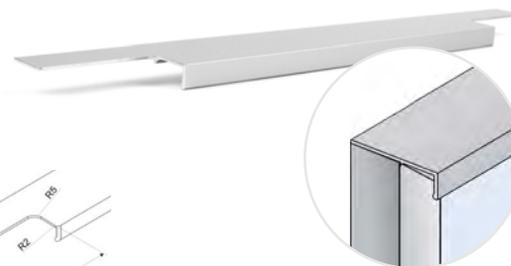
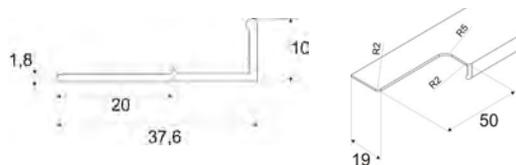

BARVA / DÉLKA (MM)	196	246	296	346	396	446	496	546	596	696	796	896	996	1 196
hliník	793830	793831	793832	793833	793834	793835	793836	793837	793838	793839	793840	793841	793842	793843
nerez světlý	793872	793873	793874	793875	793876	793877	793878	793879	793880	793881	793882	793883	793884	793885
nerez tmavý	793886	793887	793888	793889	793890	793891	793892	793893	793894	793895	793896	793897	793898	793899
chrom	793844	793845	793846	793847	793848	793849	793850	793851	793852	793853	793854	793855	793856	793857
černá	793858	793859	793860	793861	793862	793863	793864	793865	793866	793867	793868	793869	793870	793871



V případě, že potřebujete jiný rozměr profilové úchytky, obraťte se na naše obchodní oddělení. Vybrané druhy úchytek nabízíme také v provedení metráž, více informací na následující straně.

UK 8 N

- > materiál hliník
- > barva hliník, světlý nerez, tmavý nerez, chrom, černá



lakování RAL

lakování IGP

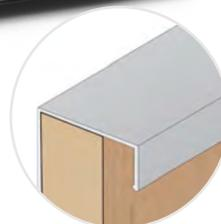
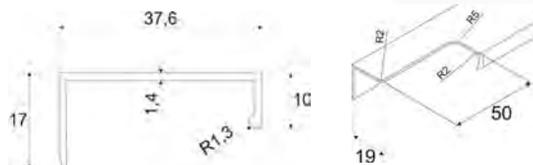

BARVA / DÉLKA (MM)	196	246	296	346	396	446	496	546	596	696	796	896	996	1 196
hliník	793900	793901	793902	793903	793904	793905	793906	793907	793908	793909	793910	793911	793912	793913
světlý nerez	793942	793943	793944	793945	793946	793947	793948	793949	793950	793951	793952	793953	793954	793955
tmavý nerez	793956	793957	793958	793959	793960	793961	793962	793963	793964	793965	793966	793967	793968	793969
chrom	793914	793915	793916	793917	793918	793919	793920	793921	793922	793923	793924	793925	793926	793927
černá	793928	793929	793930	793931	793932	793933	793934	793935	793936	793937	793938	793939	793940	793941

UK 9

- > materiál hliník
- > barva hliník, světlý nerez, tmavý nerez, šedý nerez, černá



lakování RAL

lakování IGP

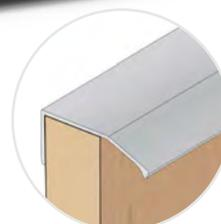
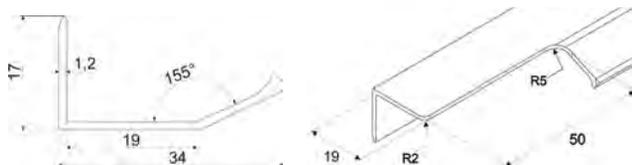

BARVA / DÉLKA (MM)	196	246	296	346	396	446	496	546	596	696	796	896	996	1 196
hliník	793970	793971	793972	793973	793974	793975	793976	793977	793978	793979	793980	793981	793982	793983
světlý nerez	793998	793999	794000	794001	794002	794003	794004	794005	794006	794007	794008	794009	794010	794011
tmavý nerez	794026	794027	794028	794029	794030	794031	794032	794033	794034	794035	794036	794037	794038	794039
šedý nerez	794012	794013	794014	794015	794016	794017	794018	794019	794020	794021	794022	794023	794024	794025
černá	793984	793985	793986	793987	793988	793989	793990	793991	793992	793993	793994	793995	793996	793997

UK 10

- > materiál hliník
- > barva hliník, černá



lakování RAL

lakování IGP

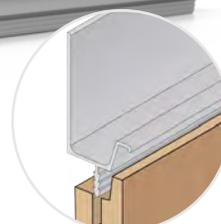
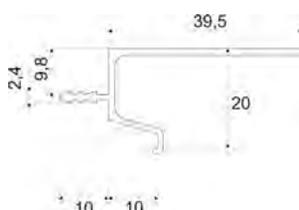

BARVA / DÉLKA (MM)	196	246	296	346	396	446	496	546	596	696	796	896	996	1 196
hliník	794040	794041	794042	794043	794044	794045	794046	794047	794048	794049	794050	794051	794052	794053
černá	794054	794055	794056	794057	794058	794059	794060	794061	794062	794063	794064	794065	794066	794067



V případě, že potřebujete jiný rozměr profilové úchytky, obraťte se na naše obchodní oddělení. Vybrané druhy úchytek nabízíme také v provedení metráž, více informací na následující straně.

7.9 PROFILOVÉ ÚCHYTKY - METRÁŽ

7 ÚCHYTKY, VĚŠÁKY A PROFILY



UK 11

- > materiál hliník
- > barva hliník, černá



lakování RAL lakování IGP

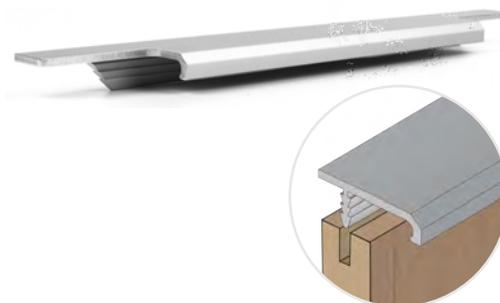
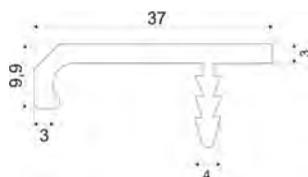

BARVA / DÉLKA (MM)	196	246	296	346	396	446	496	546	596	696	796	896	996	1 196
hliník	794068	794069	794070	794071	794072	794073	794074	794075	794076	794077	794078	794079	794080	794081
černá	794082	794083	794084	794085	794086	794087	794088	794089	794090	794091	794092	794093	794094	794095

PROFILOVÉ ÚCHYTKY - METRÁŽ

Úchytka lze rovněž zakoupit jako **úchytový profil v metráži v délce 3 m**. U této varianty není odfrézovaný stromeček k naražení do dveří. Profil je však zapotřebí zkrátit na potřebnou délku, odfrézovat stromeček profilu k naražení do dveří a začistit hranu profilu. Tato varianta je časově náročnější na přípravu a finální zpracování.

UK 2

- > délka 3 m
- > materiál hliník
- > barva hliník

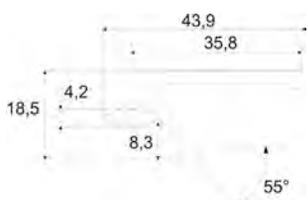
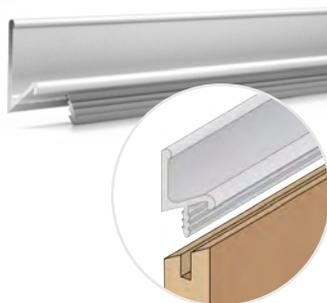

BARVA	KÓD
hliník	794096

UK 4

- > délka 3 m
- > materiál hliník
- > barva hliník

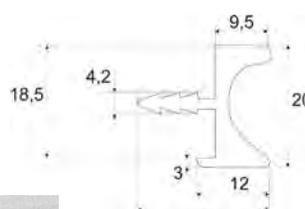
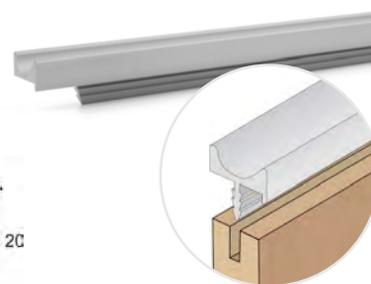

BARVA	KÓD
hliník	794097

UK 5

- > délka 3 m
- > materiál hliník
- > barva hliník, nerez

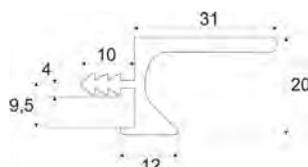
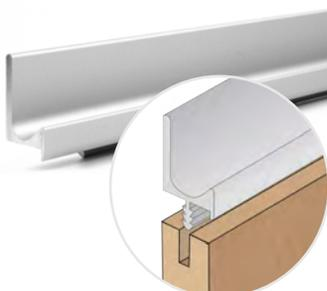

BARVA	KÓD
hliník	541585
nerez	794098

UK 6

- > délka 3 m
- > materiál hliník
- > barva hliník

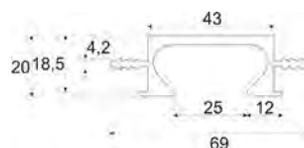
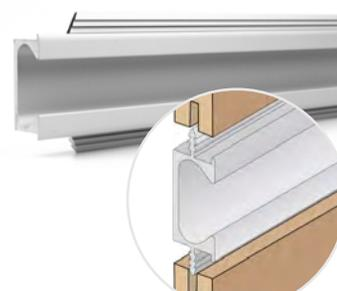

BARVA	KÓD
hliník	794099

dodání do 24 hodin dodání do 5 dní na objednávku / na dotaz

7.9 PROFILOVÉ ÚCHYTKY - METRÁŽ

7 ÚCHYTKY, VĚŠÁKY A PROFILY



UK 7

- > délka 3 m
- > materiál hliník
- > barva hliník, světlý nerez, tmavý nerez

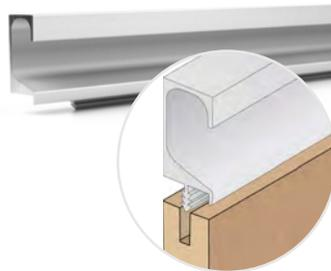
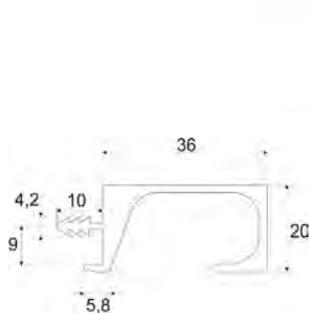

BARVA	KÓD
hliník	569249
nerez	683933



animadomus by Laguna®

LKW 5

- > délka 2,75 m
- > barva hliník

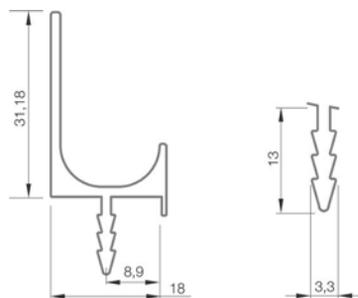

BARVA	KÓD
hliník	418653

LKW 7

- > délka 2,75 m
- > barva hliník

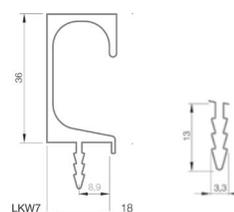

BARVA	KÓD
hliník	425389

PROFILY PRO BEZÚCHYTKOVÉ OTEVÍRÁNÍ

Profily pro bezúchytkové otevírání jsou velmi oblíbené pro **kuchyňská dvířka s čistou linií**.

Umístění profilu je vždy z vnitřní strany dvířek. Jsou upevňovány do lamina, 22 mm od horního okraje a 38,5 mm od bočního okraje. Otvor pro příchytka – plast 5 mm, kov 8 mm. Rozteč mezi otvory je 32 mm.

ÚPEVNĚNÍ PROFILŮ:

- > **Plastovou příchytka (vodorovné)** - příchytka se naráží přímo do vyvrtaných otvorů. Profil je přichycen zářezkou ve tvaru „H“.
- > **Kovovou příchytka (vodorovné)** - do vyvrtaných otvorů jsou vloženy plastové hmoždinky (M4), do kterých se příchytka montuje napevno pomocí šroubků. Profil je přichycen zářezkou se šroubkem.
- > **Vrtáním (svislý)** - profil je upevněn zápusťnými vruty do plechu (4,2 x 25) přes lamino, 20 mm od hrany.



MONTÁŽNÍ NÁVOD
profil J a C



FRÉZOVÁNÍ DO KORPUSU
profil J a C



Profil „C“ a „J“ vertikální hranový

Profil „C“ a „J“ vertikální

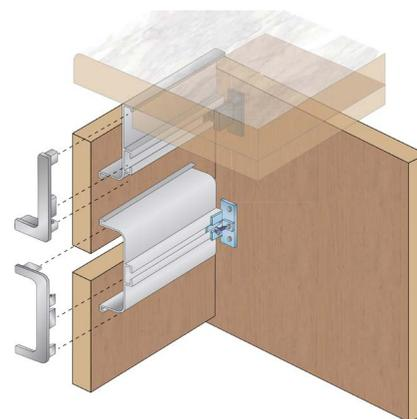
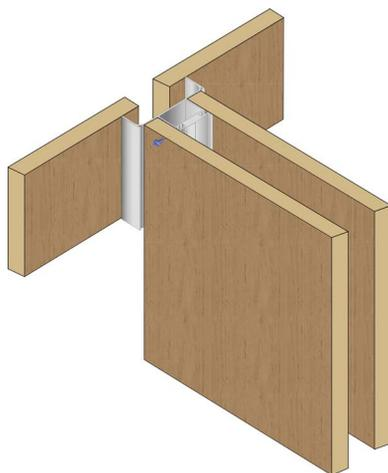
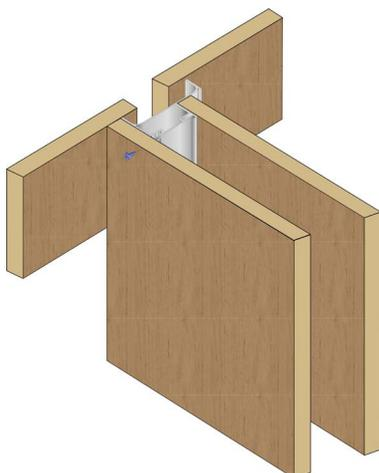

Úchytkový profil „C“

- > vodorovný profil pod pracovní desku
- > tvar profilu C
- > délka 3 m
- > materiál hliník
- > pov. úprava elox (hliník, nerez šedý), komaxit (černá)
- > barva bílá, hliník, nerez šedý, nerez světlý nebo černá



BARVA	KÓD
bílá	818979
hliník	789395
nerez šedý	789396
nerez světlý	818980
černá	801195



Úchytkový profil „J“

- > vodorovný profil pod pracovní desku
- > tvar profilu J
- > délka 3 m
- > materiál hliník
- > pov. úprava elox (hliník, nerez šedý), komaxit (černá)
- > barva bílá, hliník, nerez šedý, nerez světlý nebo černá



BARVA	KÓD
bílá	818981
hliník	789403
nerez šedý	789404
nerez světlý	818982
černá	801199



Úchytový profil svislý hranový

- > svislý profil pro montáž na hranu (profil slouží rovněž jako ukončovací profil)
- > délka 3 m
- > materiál hliník
- > pov. úprava elox (hliník, nerez šedý), komaxit (černá)
- > barva bílá, hliník, nerez šedý, nerez světlý nebo černá

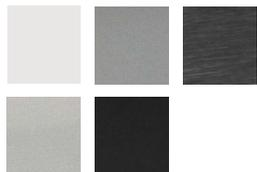

BARVA	KÓD
bílá	818985
hliník	789408
nerez šedý	789410
nerez světlý	818986
černá	801203



Úchytový profil svislý

- > svislý profil
- > délka 3 m
- > materiál hliník
- > pov. úprava elox (hliník, nerez šedý), komaxit (černá)
- > barva bílá, hliník, nerez šedý, nerez světlý nebo černá



BARVA	KÓD
bílá	818983
hliník	789411
nerez šedý	789412
nerez světlý	818984
černá	801204



DOPORUČENÉ PŘÍSLUŠENSTVÍ

Vnější roh

- > vnější roh pro úchytové profily „C“ nebo „J“
- > materiál hliník
- > pov. úprava elox (hliník), komaxit (černá)
- > barva hliník nebo černá



PRO PROFIL	BARVA	KÓD
„C“	elox	789400
	černá	801196
„J“	elox	789406
	černá	801200



Vnitřní roh

- > vnitřní roh pro úchytové profily „C“ nebo „J“
- > materiál hliník
- > pov. úprava elox (hliník), komaxit (černá)
- > barva hliník nebo černá



PRO PROFIL	BARVA	KÓD
„C“	elox	789401
	černá	801197
„J“	elox	789407
	černá	801201



Záslepka

- > záslepka pro úchytové profily „C“ nebo „J“
- > materiál hliník
- > pov. úprava elox (hliník), komaxit (černá)
- > barva hliník nebo černá

PRO PROFIL	BARVA	KÓD
„C“	elox	789402
	černá	801198
„J“	elox	789409
	černá	801202



Kovový úchyt profilu

- > kovový příchyt (vodorovný) pro úchytové profily „C“ nebo „J“
- > materiál ocel

PRODUKT	KÓD
úchyt profilu	789398



Plastový úchyt profilu

- > plastový příchyt (vodorovný) pro úchytové profily „C“ nebo „J“
- > materiál plast

PRODUKT	KÓD
úchyt profilu	789399



Spojovací úhelník

- > spojovací úhelník pro úchytový profil „C“ a „J“
- > materiál ocel

PRODUKT	KÓD
spojovací úhelník	789397





ÚCHYTKY

ALINA



chrom lesklý bronz broušený nikel broušený

BAREVNÉ PROVEDENÍ	ROZTEČ	KÓD
bronz broušený	128	825672
	160	825673
	320	825674
černá mat	128	825666
	160	825667
	320	825668
chrom lesklý	128	825669
	160	825670
	320	825671
nikel broušený	128	825675
	160	825676
	320	825677

JULIE



chrom lesklý nikel broušený

BAREVNÉ PROVEDENÍ	ROZTEČ	KÓD
černá mat	160	825687
chrom lesklý	160	825688
nikel broušený	160	825689

KORINA



nikel broušený

BAREVNÉ PROVEDENÍ	ROZTEČ	KÓD
černá mat	32	825653
	128	825654
	224	825655
	320	825656
nikel broušený	32	825649
	128	825650
	224	825651
	320	825652

LORA



hliník chrom lesklý nikel broušený matný nikel satén

BAREVNÉ PROVEDENÍ	ROZTEČ	KÓD
černá mat	160	825725
	256	825726
	320	825727
	160	825713
hliník	256	825714
	320	825715
chrom lesklý	160	825722
	256	825723
nikel broušený-matný	320	825724
	160	825719
	256	825720
nikel satén	320	825721
	160	825716
	256	825717
	320	825718

NIKOLETA



nikel broušený / černá nikel broušený / bílá

BAREVNÉ PROVEDENÍ	ROZTEČ	KÓD
černá mat	160	825690
	224	825691
	320	825692
nikel broušený/bílá	160	825696
	224	825697
	320	825698
nikel broušený/černá	160	825693
	224	825694
	320	825695



Julie

NORA



BAREVNÉ PROVEDENÍ	ROZTEČ	KÓD
černá mat-broušená	128	825744
	160	825745
	192	825746
	320	825747
	128	825728
hliník	160	825729
	192	825730
	320	825731
	128	825740
chrom lesklý	160	825741
	192	825742
	320	825743
	128	825736
nikl broušený-matný	160	825737
	192	825738
	320	825739
	128	825732
nikl satén	160	825733
	192	825734
	320	825735

SALMA



BAREVNÉ PROVEDENÍ	ROZTEČ	KÓD
černá mat	128	825657
	224	825658
	320	825659
chrom lesklý	128	825660
	224	825661
	320	825662
	128	825663
nikl broušený	224	825664
	320	825665



Nora

PORTOS



BAREVNÉ PROVEDENÍ	ROZTEČ	KÓD
černá mat	96	825772
	128	825773
	160	825774
	192	825775
	224	825776
	320	825777
	448	825778
	544	825779
	640	825780
	736	825781
	96	553014
hliník	128	344298
	160	344300
	192	344302
	224	344304
	320	344306
	448	344308
	544	344310
	640	344312
	736	344314
	96	553015
	128	344299
nerez	160	344301
	192	344303
	224	344305
	320	344307
	448	344309
	544	344311
	640	344313
	736	344315

SALOME



BAREVNÉ PROVEDENÍ	ROZTEČ	KÓD
černá mat-broušená	160	825710
	256	825711
	320	825712
chrom lesklý	160	825707
	256	825708
	320	825709
	160	825704
nikl satén	256	825705
	320	825706

SANDY II



BAREVNÉ PROVEDENÍ	ROZTEČ	KÓD
chrom lesklý/nerez	160	825646
	256	825647
	384	825648



Sheila

SHEILA



BAREVNÉ PROVEDENÍ	ROZTEČ	KÓD
černá mat-broušená	128	825764
	160	825765
	192	825766
	320	825767
	128	825748
hliník	160	825749
	192	825750
	320	825751
chrom lesklý	128	825760
	160	825761
	192	825762
nikl broušený	320	825763
	128	825768
	160	825769
nikl broušený-matný	192	825770
	320	825771
	128	825756
nikl satén	160	825757
	192	825758
	320	825759
nikl broušený	128	825752
	160	825753
	192	825754
nikl broušený-matný	320	825755

TABITA



BAREVNÉ PROVEDENÍ	ROZTEČ	KÓD
černá mat	128	825678
	224	825679
	320	825680
chrom lesklý	128	825681
	224	825682
	320	825683
nikl broušený	128	825684
	224	825685
	320	825686



Tabita

ZORA



BAREVNÉ PROVEDENÍ	ROZTEČ	KÓD
černá mat-broušená	160	825703
hliník	160	825699
chrom lesklý	160	825702
nikl broušený-matný	160	825701
nikl satén	160	825700

LIMA



nikl jemně broušený antracit lesklý

BAREVNÉ PROVEDENÍ	ROZTEČ	KÓD
antracit lesklý	160	787884
nikl jemně broušený	160	787885
železo broušené	160	787886

JOLANA



chrom satén nikl jemně broušený

BAREVNÉ PROVEDENÍ	ROZTEČ	KÓD
chrom satén	96	823017
nikl jemně broušený	96	823018
nikl mat	96	823019

KAROLINA



mosaz lesk chrom lesklý

BAREVNÉ PROVEDENÍ	ROZTEČ	KÓD
chrom lesklý	96	823046
	128	823048
mosaz lesk	128	823050
	96	823047
nikl mat	128	823049

KAIRA



chrom lesklý nikl jemně broušený

BAREVNÉ PROVEDENÍ	ROZTEČ	KÓD
	160	787870
černá mat	320	787875
	640	787879
	160	787871
chrom lesklý	320	787876
	640	787880
	160	787872
nikl jemně broušený	320	787877
	640	787881

DORA II



chrom lesklý chrom satén

BAREVNÉ PROVEDENÍ	ROZTEČ	KÓD
	64	823040
černá matná	96	823020
	128	823026
	64	823041
chrom lesklý	96	823021
	128	823027
	160	823032
	64	823042
chrom satén	96	823022
	128	823028
	192	823036
	64	823045
	96	823025
mosaz lesk	128	823031
	160	823035
	192	823039
nerezová ocel černá	96	859440
	128	859439
	64	823043
nikl jemně broušený	96	823023
	128	823029
	160	823033
	192	823037
	64	823044
	96	823024
nikl mat	128	823030
	160	823034
	192	823038



mosaz lesk nerezová ocel černá



nikl jemně broušený nikl mat

ABUDA



chrom

BAREVNÉ PROVEDENÍ	ROZTEČ	KÓD
chrom	128	767630
chrom satén	128	767629

VALEDA



železo broušené

BAREVNÉ PROVEDENÍ	ROZTEČ	KÓD
černá mat	288	831575
železo broušené	288	845230

7.1 KOVOVÉ ÚCHYTKY 7 ÚCHYTKY, VĚŠÁKY A PROFILY

MEDILA



černá mat

BAREVNÉ PŘÍKRYTÍ	ROZTEČ	KÓD
černá mat	192	843445
	448	843446
	576/704	836288
chrom lesklý	192	802113
	448	802114
	576/704	802115

BALDONE



chrom
matný nerez
finiš

BAREVNÉ PŘÍKRYTÍ	ROZTEČ	KÓD
černá mat	96	808812
	160	808810
	256	808811
	96	350962
	128	350986
chrom matný	160	351032
	256	351233
	96	350995
nerez finiš	128	351016
	160	351056
	256	351269

NURSIA

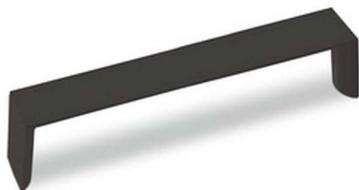

BAREVNÉ PŘÍKRYTÍ	ROZTEČ	KÓD
černá mat	160	808922

TORNEA



chrom
lesklý imitace
nerezi

BAREVNÉ PŘÍKRYTÍ	ROZTEČ	KÓD
černá mat	160	808946
	128	351074
chrom lesklý	192	351159
	128	351134
imitace nerezí	192	351198

STABIA



elox nerez
kartáčovaná

BAREVNÉ PŘÍKRYTÍ	ROZTEČ	KÓD
chrom lesk	224/236	665095
	64	664636
	96	058847
elox	128	071280
	160	063409
	192	664637
	224	044979
	64	724075
nerez kartáčovaná	96	664640
	128	664641
	160	664642
	192	664639
	224	665094

FORLI



BAREVNÉ PŘÍKRYTÍ	ROZTEČ	KÓD
nerez broušený	160	665121

PONZONE



BAREVNÉ PŘÍKRYTÍ	ROZTEČ	KÓD
čínový vzhled	128	666285

TEMPE

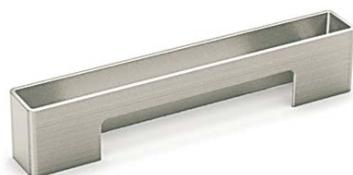

BAREVNÉ PROVEDENÍ	ROZTEČ	KÓD
nerez broušený	192	666502

ROVIGO



BAREVNÉ PROVEDENÍ	ROZTEČ	KÓD
nerez broušený	224	666633

SANTIAGO



BAREVNÉ PROVEDENÍ	ROZTEČ	KÓD
provazová úchytka	optimálně 64	793135
plastová s flexibilní roztečí	optimálně 128	721488
	optimálně 192	820130

NARNI



BAREVNÉ PROVEDENÍ	ROZTEČ	KÓD
nerezová ocel kartáčovaná	50	664993

KNOPKY

GALLENO



BAREVNÉ PROVEDENÍ	PRŮMĚR	KÓD
nerez broušený	35	666296

ISSA



BAREVNÉ PROVEDENÍ	PRŮMĚR	KÓD
černá mat	40	808889
chrom lesk	40	666591

chrom lesk

BONA



BAREVNÉ PROVEDENÍ	PRŮMĚR	KÓD
chrom lesk	30	690805

LONDA

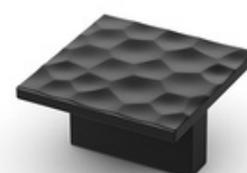

BAREVNÉ PROVEDENÍ	ROZMĚR	KÓD
černá matná	50x50	808912

VIANA



BAREVNÉ PROVEDENÍ	PRŮMÉR	KÓD
černá mat	16	784090
ušlechtilá ocel mat	16	787862
starozlatá	16	821477

ušlechtilá
ocel mat

černá
mat

VĚŠÁKY

TEXON malý



BAREVNÉ PROVEDENÍ	KÓD
bílá lesk	794357
černá mat	739039

bílá lesk

TEXON velký



BAREVNÉ PROVEDENÍ	KÓD
bílá lesk	794342
černá mat	724055

bílá lesk

KUBO malý



BAREVNÉ PROVEDENÍ	KÓD
černá (plast)	823013
hnědá (plast)	823014
nikl (plast)	823016
tmavě hnědá (plast)	823015

nikl

KUBO velký



BAREVNÉ PROVEDENÍ	KÓD
černá (plast)	823009
hnědá (plast)	823010
nikl (plast)	823012
tmavě hnědá (plast)	823011

nikl