

KOVOVÉ ÚCHYTKY

LILA

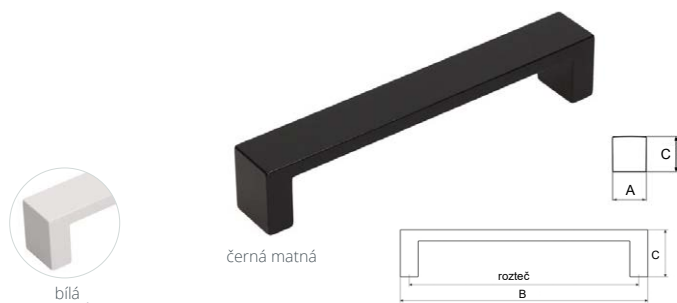

BAREVNÉ PŘÍKRYTÍ	ROZTEČ	B	A	C	KÓD
bílá matná	160	170	20	26	757689
	192	202	20	26	757690
	320	330	20	26	759762
černá mat	160	170	20	26	757687
	192	202	20	26	757688
	320	330	20	26	759763

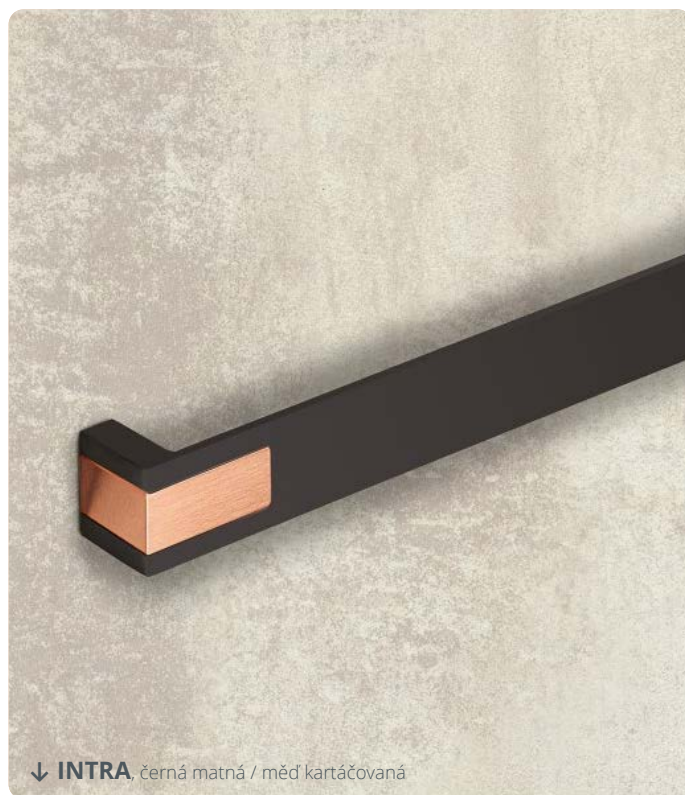

↓ INTRA, černá matná / měď kartáčovaná

INTRA



BAREVNÉ PŘÍKRYTÍ	ROZTEČ	B	A	C	KÓD
bílá matná / měď kartáčovaná	192	204	25	26	665058
černá matná / měď kartáčovaná	192	204	25	26	806040
černá matná / nerez	192	204	25	26	665056
chrom lesklý / chrom satén	192	204	25	26	351235
chrom satén / chrom lesklý	192	204	25	26	317409
nerez / chrom lesklý	192	204	25	26	317410
nerez / měď kartáčovaná	192	204	25	26	665055

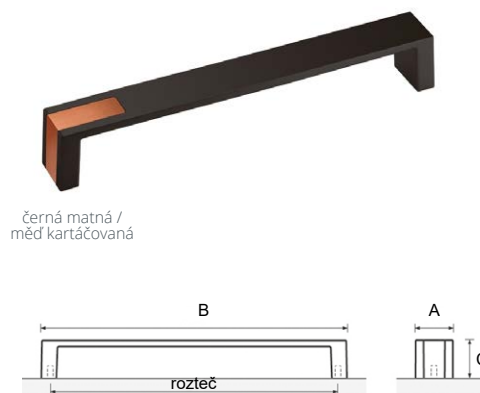

černá matná / měď kartáčovaná

ADEL



černá matná



nikl matný

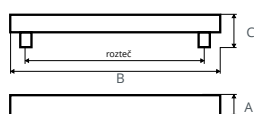

BAREVNÉ PŘÍKRYTÍ	ROZTEČ	B	A	C	KÓD
černá matná	160	168	19	27	756510
nikl matný	160	168	19	27	657410

NURSIA



černá matná



chrom matný nerez kartáčovaný



BAREVNÉ PŘÍKRYTÍ	ROZTEČ	B	A	C	KÓD
černá matná	160	168	25	30	808922
chrom matný	160	168	25	30	369570
nerez kartáčovaný	160	168	25	30	369565

7.1 KOVOVÉ ÚCHYTKY

7 ÚCHYTKY, VĚŠÁKY A PROFILY

JULI



antracit



chrom lesklý měď černá nikl jemně broušený nikl matný

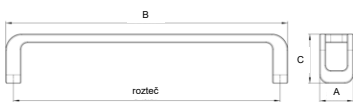

BAREVNÉ PROVEDENÍ	ROZTEČ	B	A	C	KÓD
antracit	160	169	20	29	802108
chrom lesklý	160	169	20	29	825688
měď černá	160	169	20	29	802112
nikl jemně broušený	160	169	20	29	802110
nikl matný	160	169	20	29	802111



← JULI, měď černá

REGINA



antik ocel efekt chrom lesklý chrom matný nikl jemně broušený starozlatá železo černé patina



železo broušené

BAREVNÉ PROVEDENÍ	ROZTEČ	B	A	C	KÓD
antik ocel efekt	128	161	20	27	703748
chrom lesklý	128	161	20	27	677978
chrom matný	128	161	20	27	697246
nikl jemně broušený	128	161	20	27	710503
starozlatá	128	161	20	27	794178
železo broušené	128	161	20	27	700740
železo černé patina	128	161	20	27	786253

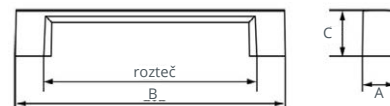

SIMA



železo černá patina



černá matná nikl jemně broušený



BAREVNÉ PROVEDENÍ	ROZTEČ	B	A	C	KÓD
černá matná	160/192	205	25	25	011664
nikl jemně broušený	160/192	205	25	25	750088
železo černá patina	160/192	205	25	25	723805

KRIS

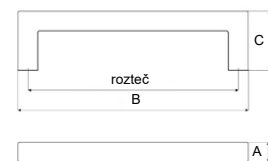

BAREVNÉ PROVEDENÍ	ROZTEČ	B	A	C	KÓD
nerez	160	180	12	22	512698
	320	340	12	22	512699

7.1 KOVOVÉ ÚCHYTKY 7 ÚCHYTKY, VĚŠÁKY A PROFILY

PORTOS



černá matná

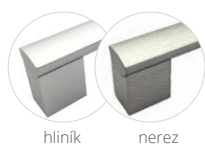

hliník nerez

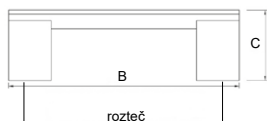

BAREVNÉ PROVEDENÍ	ROZTEČ					KÓD
černá matná	96	105	17	30	825772	
	128	137	17	30	825773	
	160	169	17	30	825774	
	192	201	17	30	825775	
	224	233	17	30	825776	
	320	329	17	30	825777	
	448	457	17	30	825778	
	544	553	17	30	825779	
	640	649	17	30	825780	
	736	745	17	30	825781	
hliník	96	105	17	30	553014	
	128	137	17	30	344298	
	160	169	17	30	344300	
	192	201	17	30	344302	
	224	233	17	30	344304	
	320	329	17	30	344306	
	448	457	17	30	344308	
	544	553	17	30	344310	
	640	649	17	30	344312	
	736	745	17	30	344314	
nerez	96	105	17	30	553015	
	128	137	17	30	344299	
	160	169	17	30	344301	
	192	201	17	30	344303	
	224	233	17	30	344305	
	320	329	17	30	344307	
	448	457	17	30	344309	
	544	553	17	30	344311	
	640	649	17	30	344313	
	736	745	17	30	344315	

PABLOS



imitace nerez

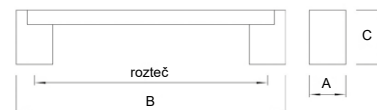

hliník / chrom lesklý hliník / chrom satén imitace nerez / chrom

BAREVNÉ PROVEDENÍ	ROZTEČ	B	A	C	KÓD	
hliník/chrom lesklý	160	180	20	30	344235	
	224	244	20	30	344237	
	320	340	20	30	344239	
	416	436	20	30	344241	
	512	532	20	30	344243	
	640	660	20	30	344245	
	736	756	20	30	344247	
	160	180	20	30	377280	
	224	244	20	30	375794	
	320	340	20	30	375795	
hliník/chrom satén	416	436	20	30	375796	
	512	532	20	30	375797	
	640	660	20	30	375798	
	736	756	20	30	375799	
	160	180	20	30	391023	
	224	244	20	30	391024	
	320	340	20	30	391025	
	imitace nerez	416	436	20	30	394637
		512	532	20	30	395739
		640	660	20	30	395740
736		756	20	30	395741	
160		180	20	30	344236	
224		244	20	30	344238	
320		340	20	30	344240	
imitace nerez/chrom		416	436	20	30	344242
		512	532	20	30	344244
		640	660	20	30	344246
	736	756	20	30	344248	

SANDY II

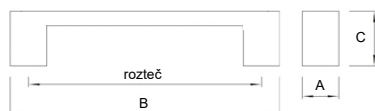

BAREVNÉ PROVEDENÍ	ROZTEČ	B	A	C	KÓD
chrom lesklý/nerez	160	179	16	25	825646
	224/256	275	16	25	825647
	352/384	403	16	25	825648

DARIA

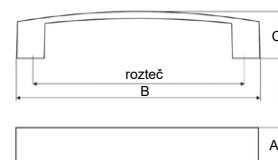

BAREVNÉ PROVEDENÍ	ROZTEČ	B	A	C	KÓD
hliník	128	146	25	28	063677

7.1 KOVOVÉ ÚCHYTKY

7 ÚCHYTKY, VĚŠÁKY A PROFILY

NOEMI



černá

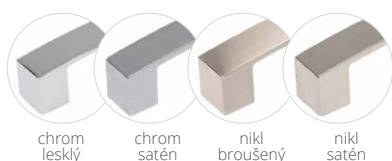
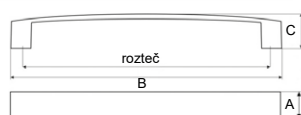

NOEMI

BAREVNÉ PROVEDENÍ	ROZTEČ	B	A	C	KÓD
černá	128	146	20	28	762445
	160	178	20	28	763002
	192	210	20	28	763003
	256	274	20	28	763004
	320	338	20	28	763005
chrom lesklý	416	434	20	28	851536
	128	146	20	28	310091
	160	178	20	28	683331
	192	210	20	28	310097
	256	274	20	28	310098
chrom satén	320	338	20	28	310099
	128	146	20	28	293899
	160	178	20	28	219554
	192	210	20	28	224267
	256	274	20	28	224270
nikl broušený	320	338	20	28	224271
	416	434	20	28	671630
	128	146	20	28	689542
	160	178	20	28	689543
	192	210	20	28	667614
nikl satén	256	274	20	28	689546
	320	338	20	28	689549
	416	434	20	28	712543
	128	146	20	28	310100
	160	178	20	28	219552
nikl satén	192	210	20	28	223176
	256	274	20	28	224266
	320	338	20	28	223732

DENY



nerez broušený

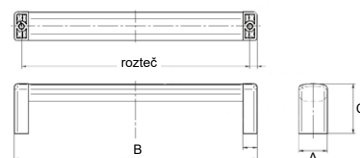

nerez / antracit

BAREVNÉ PROVEDENÍ	ROZTEČ	B	A	C	KÓD
nerez broušený	160	170	20	35	581307
	320	330	20	35	581308
nerez/antracit	160	170	20	35	581309
	320	330	20	35	581310

KORINA



černá matná



chrom lesk

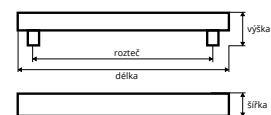

BAREVNÉ PROVEDENÍ	ROZTEČ	B	A	C	KÓD
černá matná	32	55	23	25	825653
	128	167	23	28	825654
	224	263	23	28	825655
nikl broušený	320	359	23	28	825656
	32	55	23	25	825649
	128	167	23	28	825650
	224	263	23	28	825651
	320	359	23	28	825652

SEBI



černá / chrom



bílá / chrom

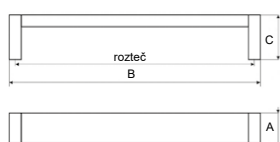

BAREVNÉ PROVEDENÍ	ROZTEČ	B	A	C	KÓD
bílá/chrom	96	104	20	30	511009
	128	136	20	30	511010
	256	264	20	30	511011
černá/chrom	96	104	20	30	511012
	128	136	20	30	511013
	256	264	20	30	511014

LORENZA



chrom satén

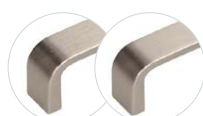

nikl broušený / nikl satén

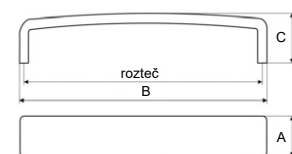

BAREVNÉ PROVEDENÍ	ROZTEČ	B	A	C	KÓD
chrom satén	128	134	20	28	410190
nikl broušený	128	134	20	28	662656
nikl satén	128	134	20	28	514624

NORA

BAREVNÉ PŘÍKRYTÍ	ROZTEČ	B	A	C	KÓD
černá matná	128	135	25	30	825744
	160	167	25	30	825745
	192	199	25	30	825746
	320	327	25	30	825747
hliník	128	135	25	30	825728
	160	167	25	30	825729
	192	199	25	30	825730
	320	327	25	30	825731
chrom lesklý	128	135	25	30	825740
	160	167	25	30	825741
	192	199	25	30	825742
	320	327	25	30	825743
nikl broušený-matný	128	135	25	30	825736
	160	167	25	30	825737
	192	199	25	30	825738
	320	327	25	30	825739
nikl satén	128	135	25	30	825732
	160	167	25	30	825733
	192	199	25	30	825734
	320	327	25	30	825735

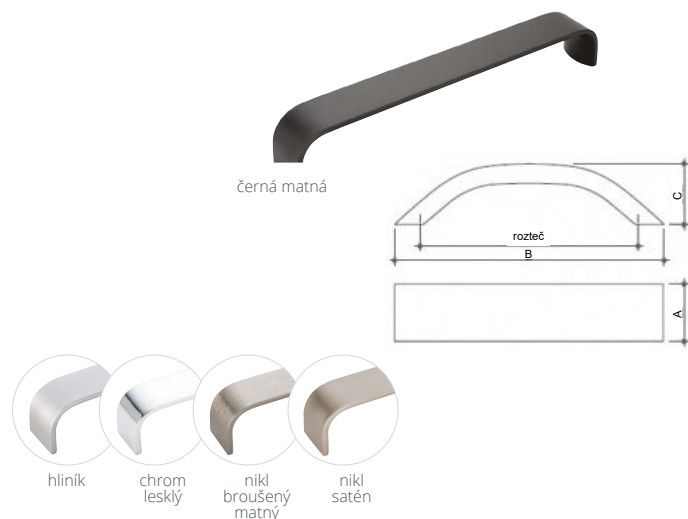

SHEILA

BAREVNÉ PŘÍKRYTÍ	ROZTEČ	B	A	C	KÓD
černá matná	128	144	24	34	825764
	160	178	24	34	825765
	192	209	24	34	825766
	320	352	24	34	825767
hliník	128	144	24	34	825748
	160	178	24	34	825749
	192	209	24	34	825750
	320	352	24	34	825751
chrom lesklý	128	144	24	34	825760
	160	178	24	34	825761
	192	209	24	34	825762
	320	352	24	34	825763
nikl broušený	128	144	24	34	825768
	160	178	24	34	825769
	192	209	24	34	825770
	320	352	24	34	825771
nikl broušený-matný	128	144	24	34	825756
	160	178	24	34	825757
	192	209	24	34	825758
	320	352	24	34	825759
nikl satén	128	144	24	34	825752
	160	178	24	34	825753
	192	209	24	34	825754
	320	352	24	34	825755

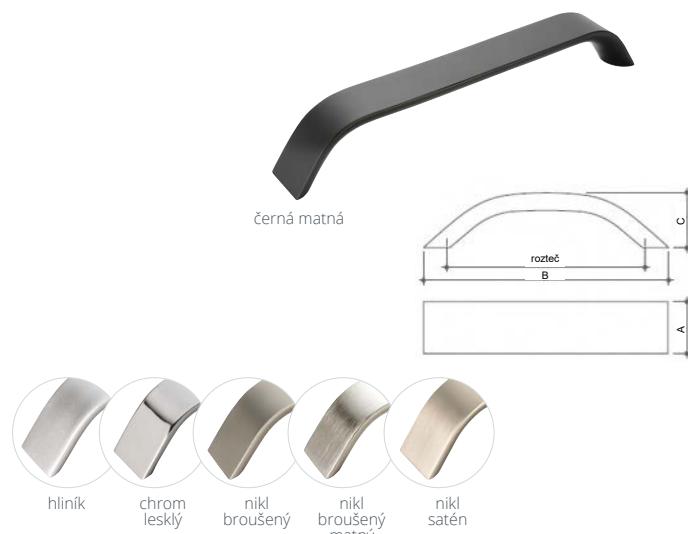

↑ SHEILA, chrom lesklý, nikl broušený matný, černá matná, nikl satén, hliník

FERIA

BAREVNÉ PŘÍKRYTÍ	ROZTEČ	B	A	C	KÓD
černá matná	96	116	25	26,5	790124
	128	146	25	26,5	790125
	160	180	25	26,5	790126
	192	212	25	26,5	761654
	224	244	25	26,5	790127
	256	275	25	26,5	790128
	320	340	25	26,5	790129

7.1 KOVOVÉ ÚCHYTKY

7 ÚCHYTKY, VĚŠÁKY A PROFILY

ANDREW



chrom satén



nikl satén

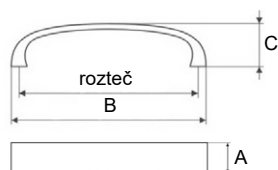

BAREVNÉ PROVEDENÍ	ROZTEČ	B	A	C	KÓD
chrom satén	96	105	12	22	063612
nikl satén	128	137	12	25	063617
	96	105	12	22	011458
	128	137	12	25	011832

BÁRA



nerez broušený/
chrom lesklý



nerez broušený /
šampaň

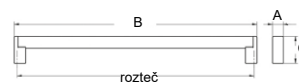

BAREVNÉ PROVEDENÍ	ROZTEČ	B	A	C	KÓD
nerez broušený/ chrom lesklý	128	138	14,5	35	581240
	160	170	14,5	35	581241
	256	266	14,5	35	581242
	320	330	14,5	35	581243
nerez broušený/ šampaň	128	138	14,5	35	581235
	160	170	14,5	35	581236
	256	266	14,5	35	581237
	320	330	14,5	35	581238

BERITA



chrom lesklý /
bílá



chrom lesklý /
černá

nikl jemně broušený /
bílá

nikl jemně broušený /
černá

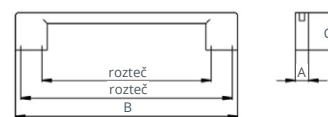

BAREVNÉ PROVEDENÍ	ROZTEČ	B	A	C	KÓD
chrom lesklý / bílá	128/160	168	10	28	687520
chrom lesklý / černá	128/160	168	10	28	644302
nikl jemně broušený / bílá	128/160	168	10	28	689517
nikl jemně broušený / černá	128/160	168	10	28	689520



↓ SAMARA, hliník černý broušený

SAMARA

BAREVNÉ PROVEDENÍ	ROZTEČ	B	A	C	KÓD
hliník černý broušený	128/224	252	10	29	873462
	224/320	348	10	29	873463
	384/480	508	10	29	873464
	640/736	764	10	29	873465
	128/224	252	10	29	298327
	160/256	284	10	29	638089
	192/288	316	10	29	357322
	224/320	348	10	29	342733
	288/384	412	10	29	541867
	320/416	444	10	29	370609
	352/448	476	10	29	708259
	384/480	508	10	29	749854
	480/576	604	10	29	381360
	640/736	764	10	29	342732
chrom lesklý	128/224	252	10	29	298328
	160/256	284	10	29	353452
	192/288	316	10	29	353449
	224/320	348	10	29	314724
	288/384	412	10	29	366844
	320/416	444	10	29	295976
	352/448	476	10	29	353446
	384/480	508	10	29	362868
	480/576	604	10	29	364772
	640/736	764	10	29	314723



hliník černý broušený



chrom lesklý

nikl jemně broušený

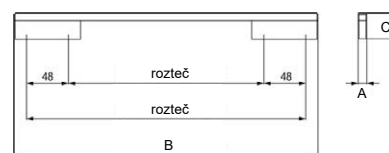

VIOLETA

BAREVNÉ PŘÍKRYTÍ	ROZTEČ	B	A	C	KÓD
antik ocel efekt	128	140	9	30	638254
	160	172	9	30	683197
	192	204	9	30	672161
bílá lesk	128	140	9	30	766454
	192	204	9	30	786704
černá matná	128	140	9	30	754951
	160	172	9	30	794407
černá měď	192	204	9	30	710900
	160	172	9	30	860440
chrom lesklý	96	108	9	30	780009
	128	140	9	30	356626
	160	172	9	30	355827
nikl jemně broušený	192	204	9	30	292275
	320	332	9	30	736378
	96	108	9	30	739290
železo broušené	128	140	9	30	351943
	160	172	9	30	366265
	192	204	9	30	387865
	320	332	9	30	741079
	160	172	9	30	678926
	192	204	9	30	688213

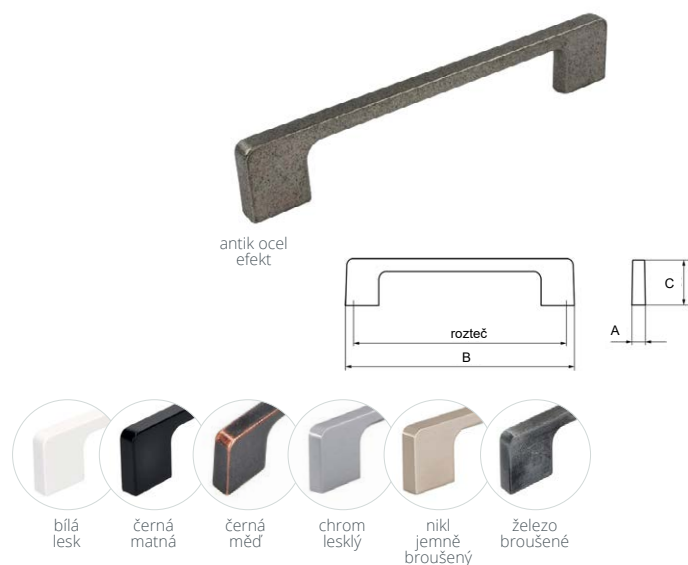

BELLUNO

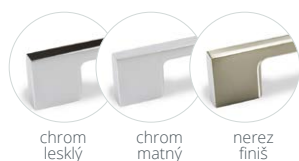

BAREVNÉ PŘÍKRYTÍ	ROZTEČ	B	A	C	KÓD
černá matná	96	130	9	28	808815
	160/192	200	9	30	808813
	224/256	267	9	30	808814
chrom lesklý	96	130	9	28	036856
	160/192	200	9	30	071236
chrom matný	224/256	267	9	30	071477
	96	130	9	28	696405
nerez finiš	160/192	200	9	30	696408
	224/256	267	9	30	040317
	96	130	9	28	351061
	160/192	200	9	30	351142
	224/256	267	9	30	351194



VIANA



BAREVNÉ PŘÍKRYTÍ	ROZTEČ	B	A	C	KÓD
černá matná	96	110	12	32	787903
	128	142	12	32	787898
	160	174	12	32	343214
	192	206	12	32	124603
	320	334	12	32	786991
	480	494	12	32	853028
ušlechtilá ocel mat	2x 368	750	12	32	855959
	96	110	12	32	787904
	128	142	12	32	787899
	160	174	12	32	787900
	192	206	12	32	787901
	320	334	12	32	787902
starozlatá	2x 368	750	12	32	864310
	160	174	12	32	873443
	320	334	12	32	020008

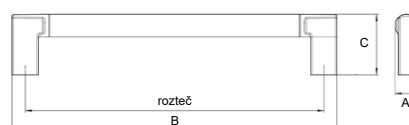

7.1 KOVOVÉ ÚCHYTKY 7 ÚCHYTKY, VĚŠÁKY A PROFILY

DARA

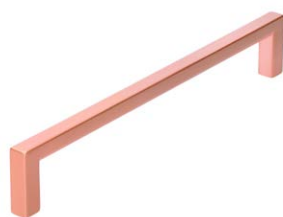

měď broušená

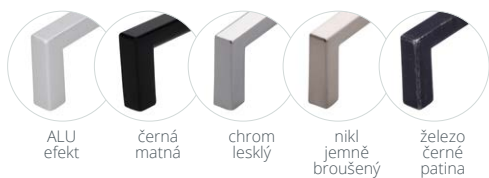
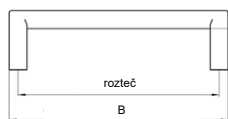

BAREVNÉ PROVEDENÍ	ROZTEČ	B	A	C	KÓD
ALU efekt	96	104	9	28	540853
	128	136	9	28	532591
	160	168	9	28	528447
	192	200	9	28	546442
	224	232	9	28	676459
černá matná	320	328	9	28	626087
	96	104	9	28	768239
	128	136	9	28	787866
	160	168	9	28	768241
	192	200	9	28	755694
chrom lesklý	224	232	9	28	208491
	320	328	9	28	787868
	96	104	9	28	522345
	128	136	9	28	571472
	160	168	9	28	528473
měď broušená	192	200	9	28	522340
	224	232	9	28	522341
	320	328	9	28	524730
	160	168	9	28	802098
	224	232	9	28	802099
nikel jemně broušený	96	104	9	28	533192
	128	136	9	28	628489
	160	168	9	28	571660
	192	200	9	28	522342
	224	232	9	28	571659
železo černá patina	320	328	9	28	516002
	128	136	9	28	787867
	160	168	9	28	738607
	320	328	9	28	787869

MILY



nikel broušený



chrom satén

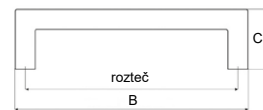

BAREVNÉ PROVEDENÍ	ROZTEČ	B	A	C	KÓD
chrom satén	192	200	8	27	376092
	320	328	8	27	376093
	448	459	8	27	376094
	96	104	8	27	376095
	128	136	8	27	376096
nikel broušený	160	168	8	27	376097
	192	200	8	27	376098
	320	328	8	27	376099
	448	459	8	27	376100

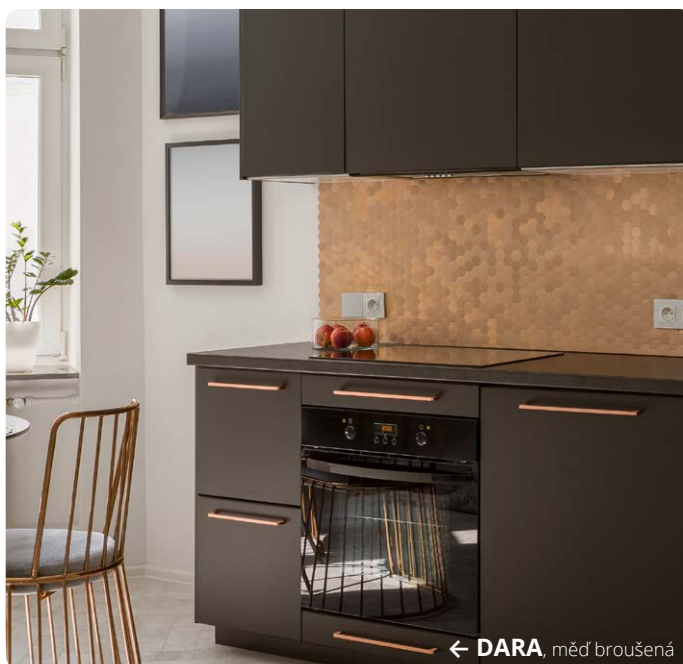

← DARA, měď broušená

TORNEA



černá matná

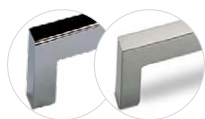

chrom lesklý
imitace nerez

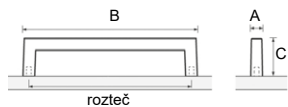

BAREVNÉ PROVEDENÍ	ROZTEČ	B	A	C	KÓD
černá matná	128	138	10	32	808946
	192	202	10	32	808947
chrom lesklý	128	138	10	32	351074
	192	202	10	32	351159
imitace nerez	128	138	10	32	351134
	192	202	10	32	351198

LENNY

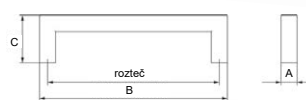

LENNY

BAREVNÉ PROVEDENÍ	ROZTEČ	B	A	C	KÓD
nerez	96	108	12	35	695707
	128	140	12	35	702222
	160	172	12	35	696857
	320	332	12	35	680663

7.1 KOVOVÉ ÚCHYTKY

7 ÚCHYTKY, VĚŠÁKY A PROFILY

ANZIO

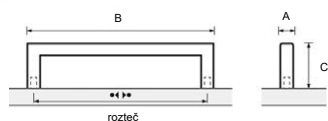

BAREVNÉ PROVEDENÍ	ROZTEČ	B	A	C	KÓD
nerez kartáčovaný	96	106	10	32	664643
	128	138	10	32	351141
	160	170	10	32	351185
	192	202	10	32	664644
	224	234	10	32	351227
	288	298	10	32	351274
	320	330	10	32	664646
	352	362	10	32	351304
	480	490	10	32	351363
	608	618	10	32	351557
736	746	10	32	351607	



BALDONE

BAREVNÉ PROVEDENÍ	ROZTEČ	B	A	C	KÓD
černá matná	96	104	11	26	808812
	128	136	11	26	808809
	160	168	11	26	808810
	256	264	15	29	808811
chrom lesklý	96	104	11	26	350963
	128	168	11	26	738015
	160	136	11	26	351031
chrom matný	256	264	15	29	351234
	96	104	11	26	350962
	160	136	11	26	351032
	256	168	11	26	351233
nerez finiš	128	264	15	29	350986
	96	104	11	26	350995
	128	136	11	26	351016
	160	168	11	26	351056
	256	264	15	29	351269



černá matná

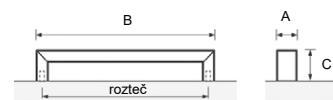

RADOS

BAREVNÉ PROVEDENÍ	ROZTEČ	B	A	C	KÓD
hliník	128	140	8	34	344263
	160	172	8	34	344266
	224	236	8	34	344269
	320	332	8	34	344272
	416 (3závitová)	428	8	34	344275
chrom lesklý	128	140	8	34	344264
	160	172	8	34	344267
	224	236	8	34	344270
	320	332	8	34	344273
	416 (3závitová)	428	8	34	344276
imitace nerezí	128	140	8	34	344265
	160	172	8	34	344268
	224	236	8	34	344271
	320	332	8	34	344274
	416 (3závitová)	428	8	34	344277



hliník

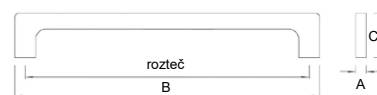

7.1 KOVOVÉ ÚCHYTKY

7 ÚCHYTKY, VĚŠÁKY A PROFILY

CHALCIS

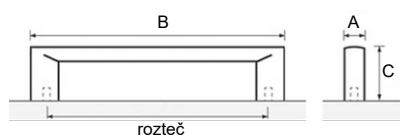

BAREVNÉ PŘÍMĚŘENÍ	ROZTEČ	B	A	C	KÓD
imitace nerezí	128	147	11	31	351039
	288	301	11	31	351238

NICOLE

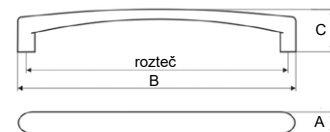

BAREVNÉ PŘÍMĚŘENÍ	ROZTEČ	B	A	C	KÓD
nikl satén	128	138	13	25	011457

IDA



chrom satén



chrom lesklý

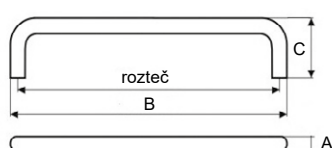

BAREVNÉ PŘÍMĚŘENÍ	ROZTEČ	B	A	C	KÓD
chrom lesklý	96	104	8	30	349277
chrom satén	96	104	8	30	349278

DORA



BAREVNÉ PŘÍMĚŘENÍ	ROZTEČ	B	A	C	KÓD
	128	136	8	30	581179
chrom lesklý	256	264	8	30	581181
	320	264	8	28	581182

DORA II

BAREVNÉ PŘÍMĚŘENÍ	ROZTEČ	B	A	C	KÓD
černá matná	64	74	10	29	823040
	96	106	10	29	823020
	128	138	10	29	823026
chrom lesklý	64	74	10	29	823041
	96	106	10	29	823021
	128	138	10	29	823027
chrom satén	160	170	10	29	823032
	64	74	10	29	823042
	96	106	10	29	823022
mosaz lesk	128	138	10	29	823028
	192	202	10	29	823036
	96	106	10	29	823025
nerezová ocel černá	128	138	10	29	823031
	160	170	10	29	823035
	192	202	10	29	823039
nikl jemně broušený	96	106	10	29	859440
	128	138	10	29	859439
	64	74	10	29	823043
nikl mat	96	106	10	29	823023
	128	138	10	29	823029
	160	170	10	29	823033
nikl mat	64	74	10	29	823044
	96	106	10	29	823024
	128	138	10	29	823030
	160	170	10	29	823034
	192	202	10	29	823038



černá matná

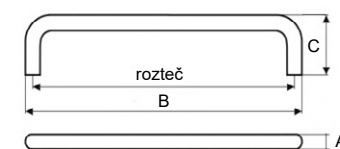

7.1 KOVOVÉ ÚCHYTKY 7 ÚCHYTKY, VĚŠÁKY A PROFILY

ARIA

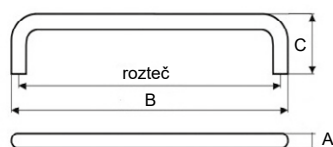

BAREVNÉ PROVEDENÍ	ROZTEČ	B	A	C	KÓD
železo broušené	160	170	10	31	047379
	320	330	10	31	873830

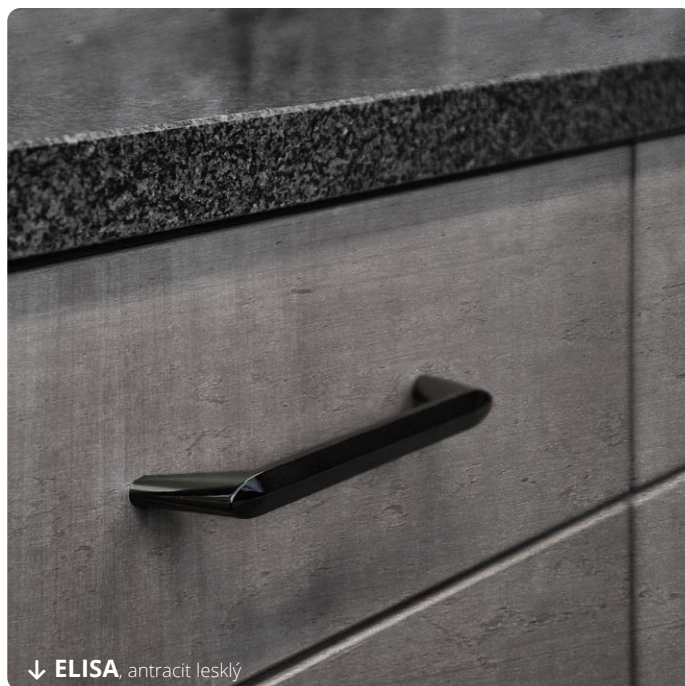

LIMA



železo broušené



nikl jemně broušený antracit lesklý

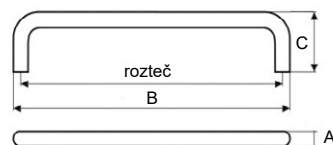

BAREVNÉ PROVEDENÍ	ROZTEČ	B	A	C	KÓD
antracit lesklý	160	171	15	31	787884
nikl jemně broušený	160	171	15	31	787885
železo broušené	160	171	15	31	787886

ELISA



antracit lesklý



chrom lesklý nikl jemně broušený

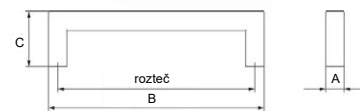

BAREVNÉ PROVEDENÍ	ROZTEČ	B	A	C	KÓD
antracit lesklý	160	174	13	31	859441
	320	335	13	31	859444
chrom lesklý	160	174	13	31	859442
	320	335	13	31	859445
nikl jemně broušený	160	174	13	31	859443
	320	335	13	31	859446

NANCY



železo černá patina



antracit lesklý

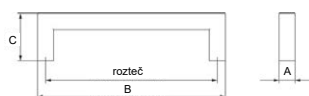

BAREVNÉ PROVEDENÍ	ROZTEČ	B	A	C	KÓD
antracit lesklý	160	190	8	34	881377
	320	350	8	34	881378
železo černá patina	160	190	8	34	491354
	320	350	8	34	829545

SALMA



černá matná



chrom lesklý nikl broušený

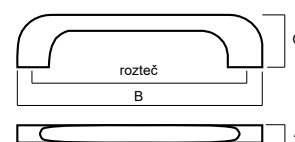

BAREVNÉ PROVEDENÍ	ROZTEČ	B	A	C	KÓD
černá matná	128	137	16	31	825657
	224	233	16	31	825658
	320	329	16	31	825659
chrom lesklý	128	137	16	31	825660
	224	233	16	31	825661
	320	329	16	31	825662
nikl broušený	128	137	16	31	825663
	224	233	16	31	825664
	320	329	16	31	825665

7.1 KOVOVÉ ÚCHYTKY

7 ÚCHYTKY, VĚŠÁKY A PROFILY

RAVENA



černá matná



nerez

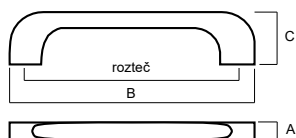

BAREVNÉ PŘÍKRYTÍ	ROZTEČ	B	A	C	KÓD
černá matná	160	184	12	28	774524
nerez	160	184	12	28	774525

TABITA



černá matná



chrom lesklý
nikl broušený

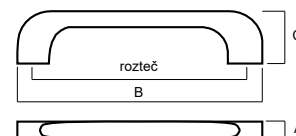

BAREVNÉ PŘÍKRYTÍ	ROZTEČ	B	A	C	KÓD
černá matná	128	158	13	25	825678
	224	255	13	25	825679
	320	351	13	25	825680
chrom lesklý	128	158	13	25	825681
	224	255	13	25	825682
	320	351	13	25	825683
nikl broušený	128	158	13	25	825684
	224	255	13	25	825685
	320	351	13	25	825686

NEIVA



antracit lesklý
chrom lesklý
nikl jemně broušený



antracit matný

BAREVNÉ PŘÍKRYTÍ	ROZTEČ	B	A	C	KÓD
antracit lesklý	160	177	15	30	655806
	320	337	15	30	754619
antracit matný	160	177	15	30	642404
	320	337	15	30	660995
chrom lesklý	128	145	15	30	519007
	160	177	15	30	748779
	320	337	15	30	519006
nikl jemně broušený	128	145	15	30	542710
	160	177	15	30	539594
	320	337	15	30	532153

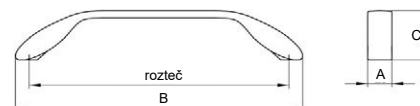

LIA



antracit



chrom lesklý
nikl jemně broušený



BAREVNÉ PŘÍKRYTÍ	ROZTEČ	B	A	C	KÓD
antracit	160	192	12	33	802123
	320	352	12	33	802126
chrom lesklý	160	192	12	33	802122
	320	352	12	33	802125
nikl jemně broušený	160	192	12	33	802124
	320	352	12	33	802127

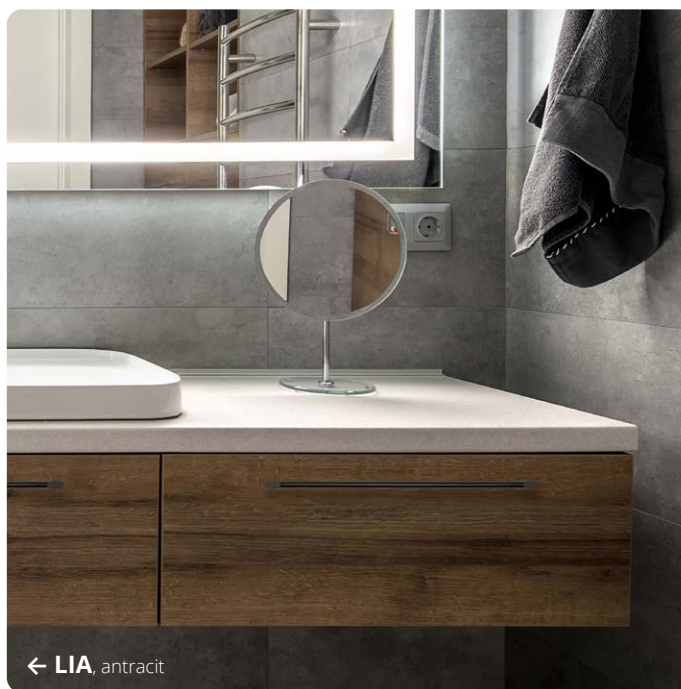

← LIA, antracit

7.1 KOVOVÉ ÚCHYTKY

7 ÚCHYTKY, VĚŠÁKY A PROFILY

LESA

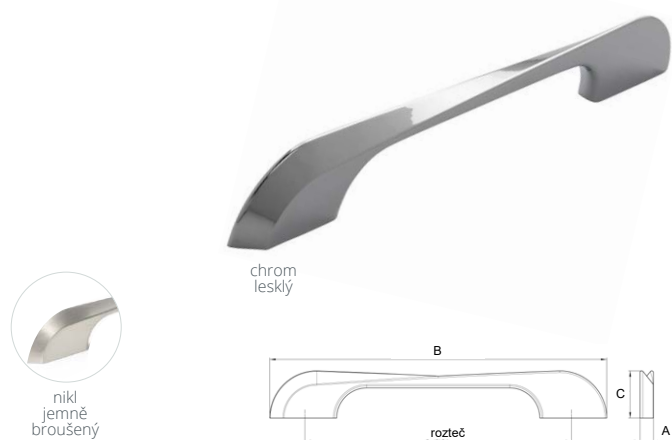

BAREVNÉ PŘÍKRYTÍ	ROZTEČ	B	A	C	KÓD
chrom lesklý	160	203	8	28	802104
chrom lesklý	224	267	8	28	802106
níkl jemně broušený	160	203	8	28	802105
níkl jemně broušený	224	267	8	28	802107

ALBA

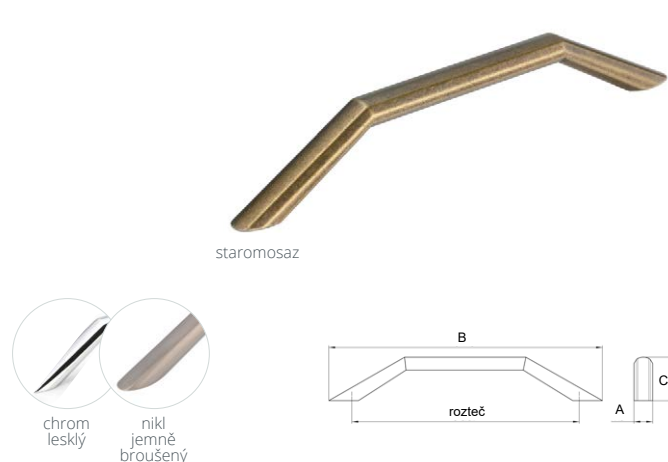

BAREVNÉ PŘÍKRYTÍ	ROZTEČ	B	A	C	KÓD
chrom lesklý	128	154	11	25	802074
níkl jemně broušený	128	154	11	25	802076
staromosaž	128	154	11	25	802075

HRAZDA 12

BAREVNÉ PŘÍKRYTÍ	ROZTEČ	B	A	C	KÓD
černá	96	156	12	31	763585
	128	188	12	31	763586
	160	220	12	31	762447
	192	272	12	31	763587
	224	304	12	31	763589
	320	400	12	31	763593
chrom lesklý	448	528	12	31	763595
	576	656	12	31	763596
	96	156	12	31	473948
	128	188	12	31	473949
	160	220	12	31	473950
	192	272	12	31	473951
chrom matný	224	304	12	31	473952
	320	400	12	31	473953
	448	528	12	31	473954
	640	720	12	31	696584
	96	156	12	31	471837
	128	188	12	31	471839
níkl broušený	160	220	12	31	471841
	192	272	12	31	471843
	224	304	12	31	471845
	320	400	12	31	471847
	448	528	12	31	471849
	576	656	12	31	471851
níkl satén	640	720	12	31	471853
	736	856	12	31	471855
	800	920	12	31	471859
	96	156	12	31	473955
	128	188	12	31	473956
	160	220	12	31	473957
níkl satén	192	272	12	31	473958
	224	304	12	31	473959
	320	400	12	31	473960
	416	496	12	31	581280
	448	528	12	31	473961
	480	560	12	31	581282
níkl satén	576	656	12	31	473962
	640	720	12	31	473963
	736	856	12	31	473964
	800	920	12	31	473965
	96	156	12	31	471838
	128	188	12	31	471840
níkl satén	160	220	12	31	471842
	192	272	12	31	471844
	224	304	12	31	471846
	320	400	12	31	471848
	448	528	12	31	471850
	576	656	12	31	471852
níkl satén	640	720	12	31	471854
	736	856	12	31	471857
800	920	12	31	471858	

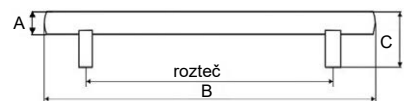

7.1 KOVOVÉ ÚCHYTKY

7 ÚCHYTKY, VĚŠÁKY A PROFILY

HRAZDA 10

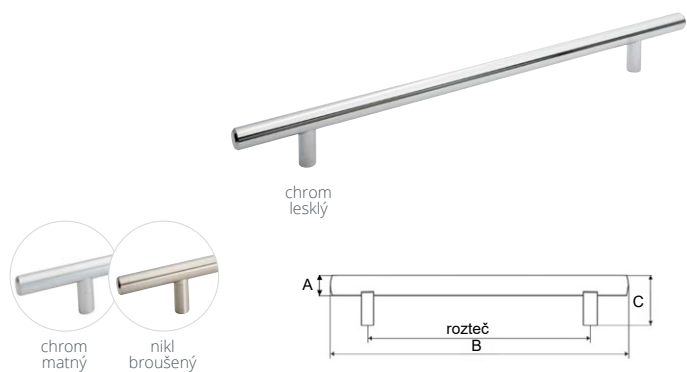

BAREVNÉ PROVEDENÍ	ROZTEČ	B	A	C	KÓD
chrom lesklý	96	156	10	32	D518853
	128	188	10	32	D518854
	160	220	10	32	D518855
chrom matný	96	156	10	32	D518850
	128	188	10	32	D518851
nikl broušený	96	156	10	32	D518847
	128	188	10	32	D518848

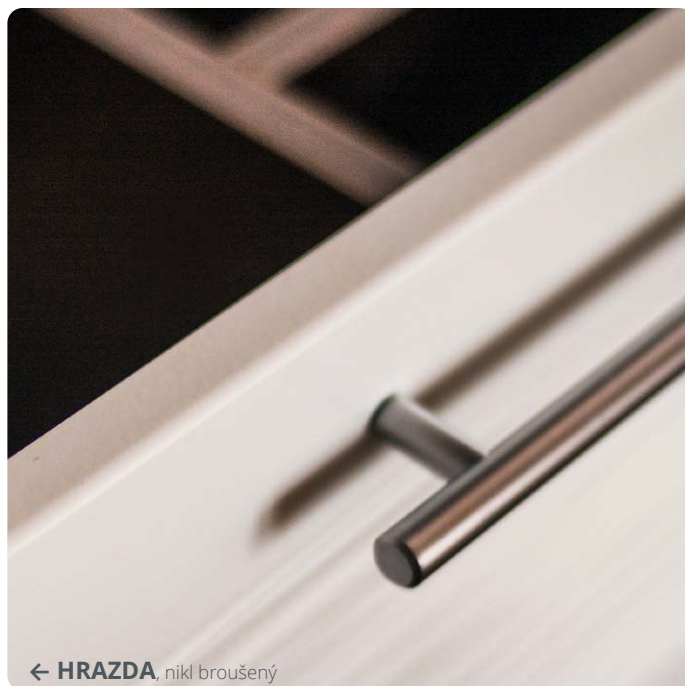

REBEKA

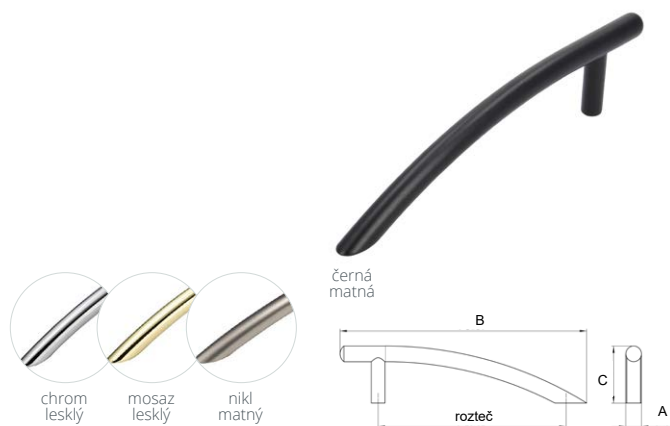

BAREVNÉ PROVEDENÍ	ROZTEČ	B	A	C	KÓD
černá matná	96	126	8	29	802133
chrom lesklý	96	126	8	29	802134
mosaz lesklý	96	126	8	29	802136
nikl matný	96	126	8	29	802135

JOVANA

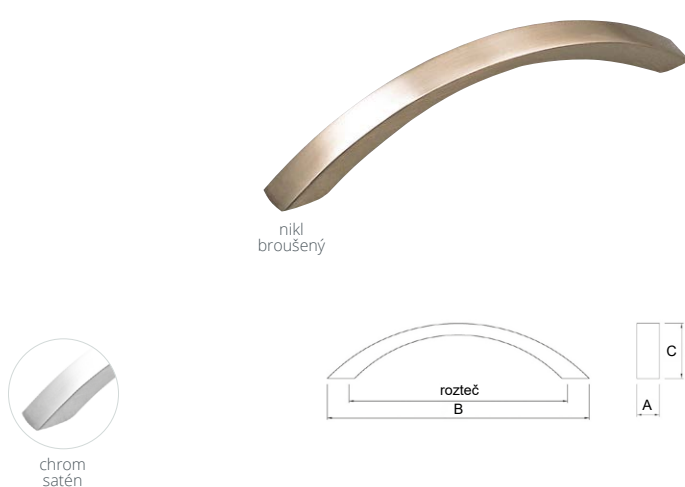

BAREVNÉ PROVEDENÍ	ROZTEČ	B	A	C	KÓD
chrom satén	128	150	10	27	344329
nikl broušený	128	150	10	27	344328

LORA

BAREVNÉ PROVEDENÍ	ROZTEČ	B	A	C	KÓD
černá matná	160	180	11	34	825725
	256	278	11	34	825726
	320	340	11	34	825727
hliník	160	180	11	34	825713
	256	278	11	34	825714
	320	340	11	34	825715
chrom lesklý	160	180	11	34	825722
	256	278	11	34	825723
	320	340	11	34	825724
nikl broušený matný	160	180	11	34	825719
	256	278	11	34	825720
	320	340	11	34	825721
nikl satén	160	180	11	34	825716
	256	278	11	34	825717
	320	340	11	34	825718

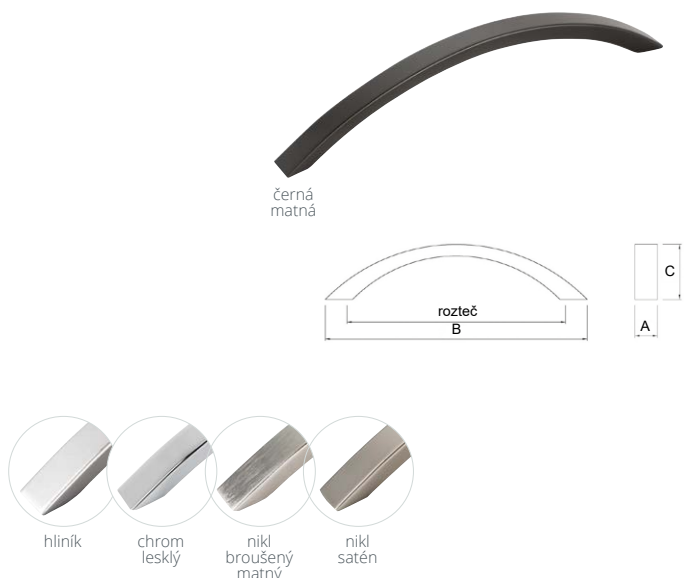

7.1 KOVOVÉ ÚCHYTKY

7 ÚCHYTKY, VĚŠÁKY A PROFILY

UGO

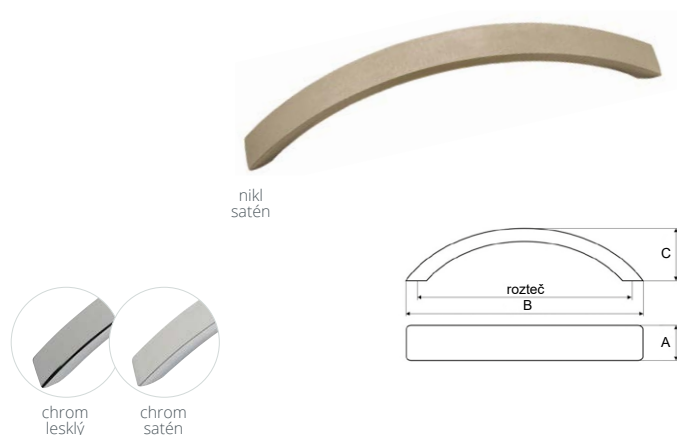

BAREVNÉ PROVEDENÍ	ROZTEČ	B	A	C	KÓD
chrom lesklý	128	145	20	30	676918
chrom satén	128	145	20	30	413452
nikl satén	128	145	20	30	063601

BALMO

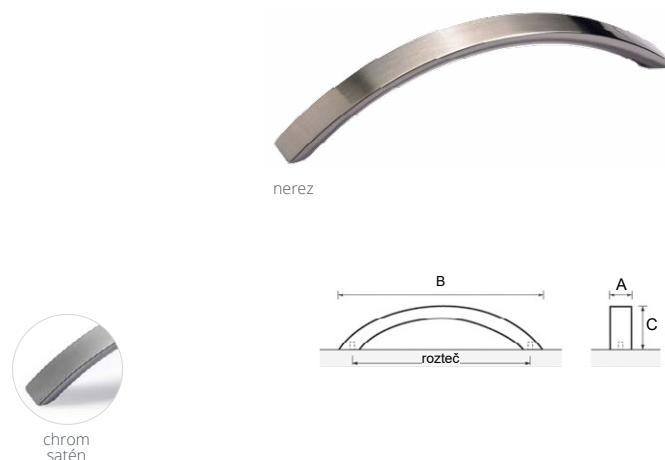

BAREVNÉ PROVEDENÍ	ROZTEČ	B	A	C	KÓD
chrom satén	128	149	15	32	062518
nerez	128	149	15	32	071527

ZORA

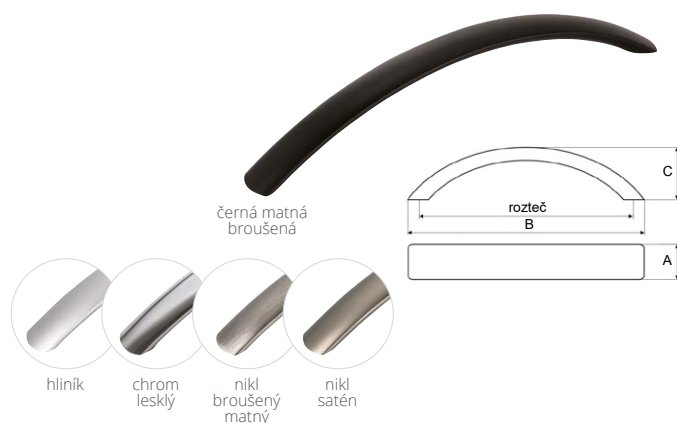

BAREVNÉ PROVEDENÍ	ROZTEČ	B	A	C	KÓD
černá matná broušená	160	180	15	32	825703
hliník	160	180	15	32	825699
chrom lesklý	160	180	15	32	825702
nikl broušený-matný	160	180	15	32	825701
nikl satén	160	180	15	32	825700

DALIA

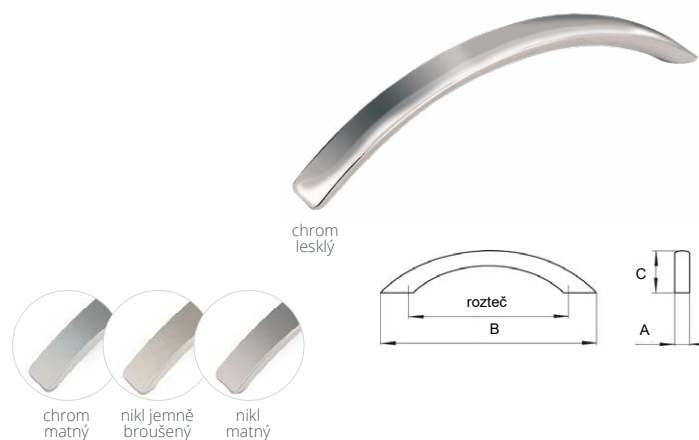

BAREVNÉ PROVEDENÍ	ROZTEČ	B	A	C	KÓD
chrom lesklý	128	146	15	30	047387
chrom matný	128	146	15	30	011655
nikl jemně broušený	128	146	15	30	038940
nikl matný	128	146	15	30	054981

VERONICA



BAREVNÉ PROVEDENÍ	ROZTEČ	B	A	C	KÓD
nikl broušený	128	144	15	30	365353

PARMA

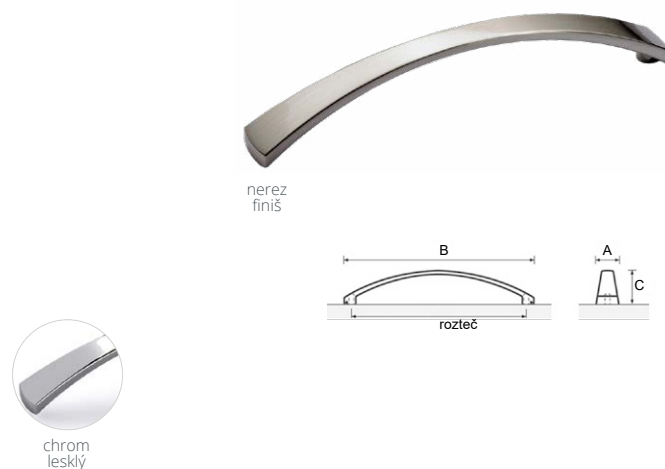

BAREVNÉ PROVEDENÍ	ROZTEČ	B	A	C	KÓD
chrom lesklý	128	138	17	25	351045
nerez finiš	128	138	17	25	351075

7.1 KOVOVÉ ÚCHYTKY

7 ÚCHYTKY, VĚŠÁKY A PROFILY

SÁRA

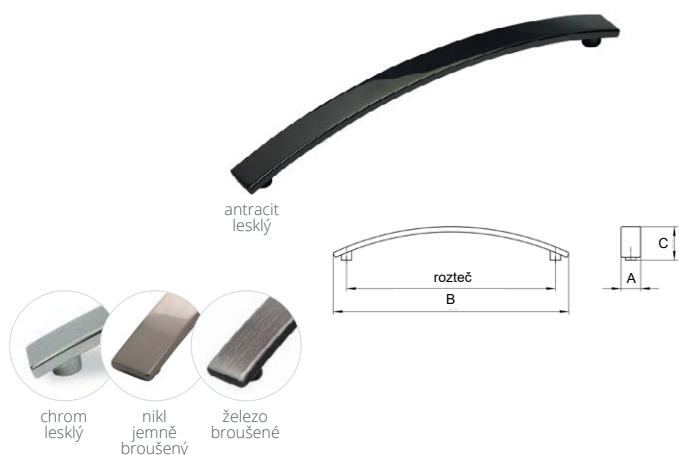

BAREVNÉ PROVEDENÍ	ROZTEČ	B	A	C	KÓD
antracit lesklý	160	181	15	25,5	647892
chrom lesklý	160	181	15	25,5	772698
nikl jemně broušený	160	181	15	25,5	567343
železo broušené	160	181	15	25,5	723340



← SÁRA, antracit lesklý

MIA

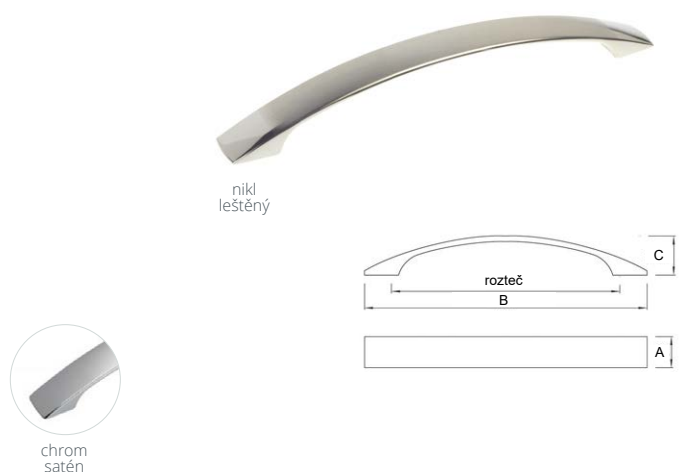

BAREVNÉ PROVEDENÍ	ROZTEČ	B	A	C	KÓD
chrom satén	160	180	21	25	413558
nikl leštěný	160	180	21	25	413560

MARINA

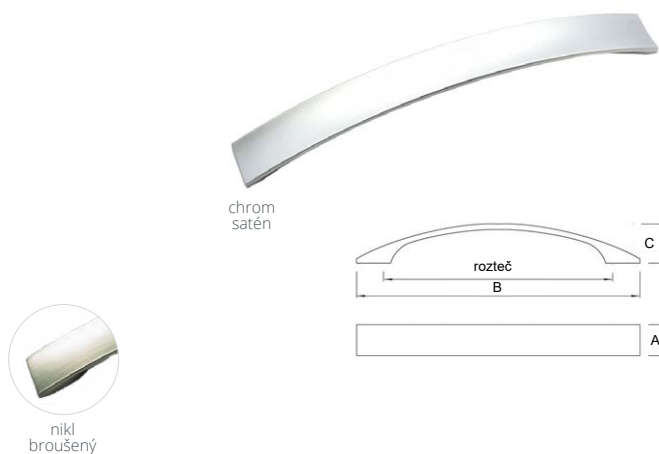

BAREVNÉ PROVEDENÍ	ROZTEČ	B	A	C	KÓD
chrom satén	160	198	22	27,5	344327
nikl broušený	160	198	22	27,5	344326

MONICA



BAREVNÉ PROVEDENÍ	ROZTEČ	B	A	C	KÓD
černá matná	96	138	20	24	861427
	128	184	20	24	861426
	96	138	20	24	011443
chrom lesklý	128	184	20	24	103439
	96	138	20	24	011444
chrom satén	128	184	20	24	063629
	96	138	20	24	035251
nikl broušený	128	184	20	24	011445
	96	138	20	24	011513
nikl satén	128	184	20	24	021520



černá matná

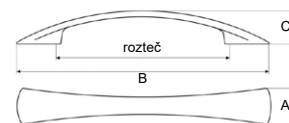

7.1 KOVOVÉ ÚCHYTKY

7 ÚCHYTKY, VĚŠÁKY A PROFILY

CRISTINA

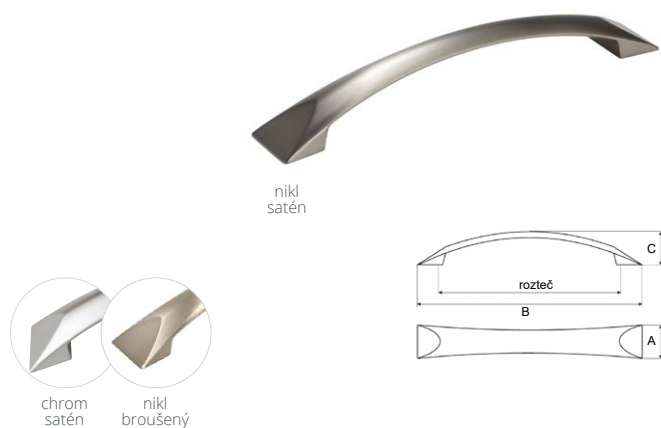

BAREVNÉ PROVEDENÍ	ROZTEČ	B	A	C	KÓD
chrom satén	128	156	23	23	185738
nikl broušený	128	156	23	23	365350
nikl satén	128	156	23	23	145966

LAURA

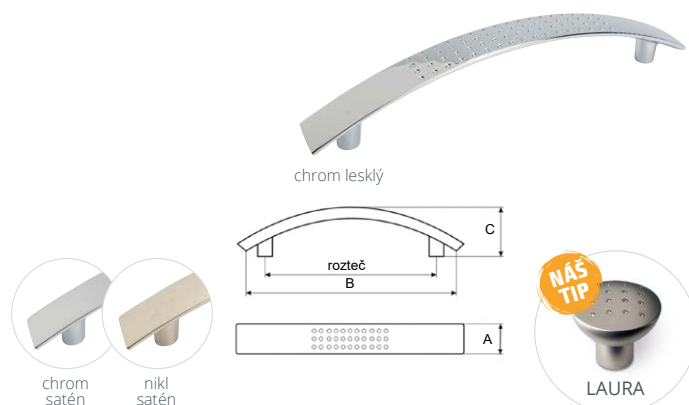

BAREVNÉ PROVEDENÍ	ROZTEČ	B	A	C	KÓD
chrom lesklý	96	124	17,5	27	037986
chrom satén	128	156	17,5	27	056895
chrom satén	96	124	17,5	27	063622
nikl satén	128	156	17,5	27	063624
nikl satén	96	124	17,5	27	011512
nikl satén	128	156	17,5	27	063623

KAROLÍNA

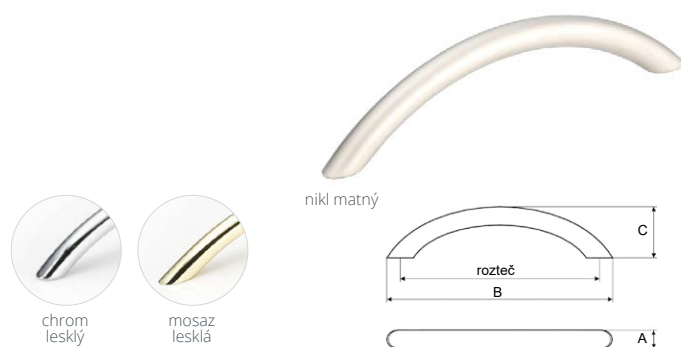

BAREVNÉ PROVEDENÍ	ROZTEČ	B	A	C	KÓD
chrom lesklý	96	108	8	24	823046
chrom lesklý	128	154	10	28	823048
nikl matný	96	108	8	24	823047
nikl matný	128	154	10	28	823049
mosaz lesklá	128	154	10	28	823050

BETA

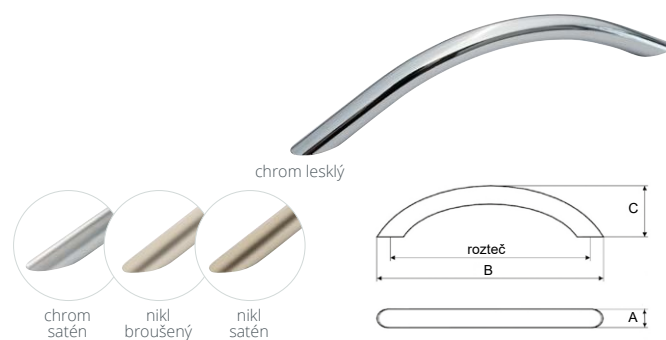

BAREVNÉ PROVEDENÍ	ROZTEČ	B	A	C	KÓD
chrom lesklý	96	113	10	30	349279
chrom lesklý	128	152	10	30	349280
chrom satén	96	113	10	30	349283
chrom satén	128	152	10	30	349284
nikl broušený	96	113	10	30	349281
nikl broušený	128	152	10	30	349282
nikl satén	96	113	10	30	349285
nikl satén	128	152	10	30	349286

ANABEL



BAREVNÉ PROVEDENÍ	ROZTEČ	B	A	C	KÓD
nerezová ocel černá	128	145	10	35	859436
nerezová ocel černá	192	223	10	35	859437
nerezová ocel černá	320	371	10	35	859438

BASILIA

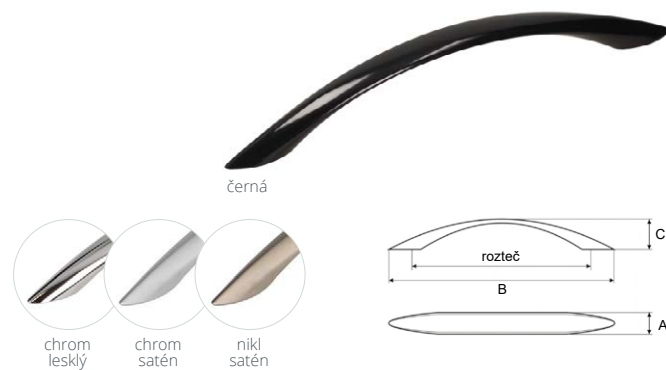

BAREVNÉ PROVEDENÍ	ROZTEČ	B	A	C	KÓD
černá	96	127	12	24	762449
černá	128	164	12	25	762783
chrom lesklý	96	127	12	24	078123
chrom lesklý	128	164	12	25	034463
chrom satén	96	127	12	24	011439
chrom satén	128	164	12	25	021504
nikl satén	96	127	12	24	011518
nikl satén	128	164	12	25	011519

7.1 KOVOVÉ ÚCHYTKY

7 ÚCHYTKY, VĚŠÁKY A PROFILY

SALOME

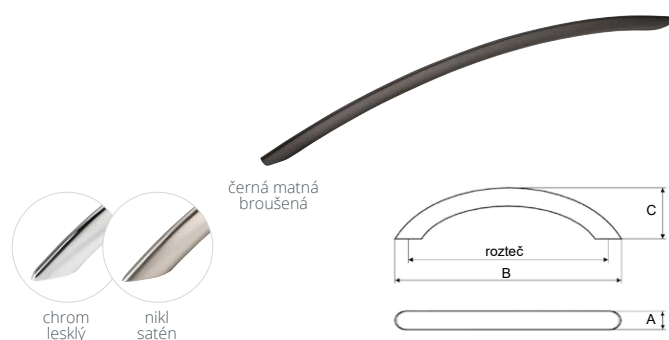

BAREVNÉ PROVEDENÍ	ROZTEČ	B	A	C	KÓD
černá matná - broušená	160	190	9	38	825710
	256	292	9	38	825711
	320	356	9	38	825712
chrom lesklý	160	190	9	38	825707
	256	292	9	38	825708
	320	356	9	38	825709
nikl satén	160	190	9	38	825704
	256	292	9	38	825705
	320	356	9	38	825706

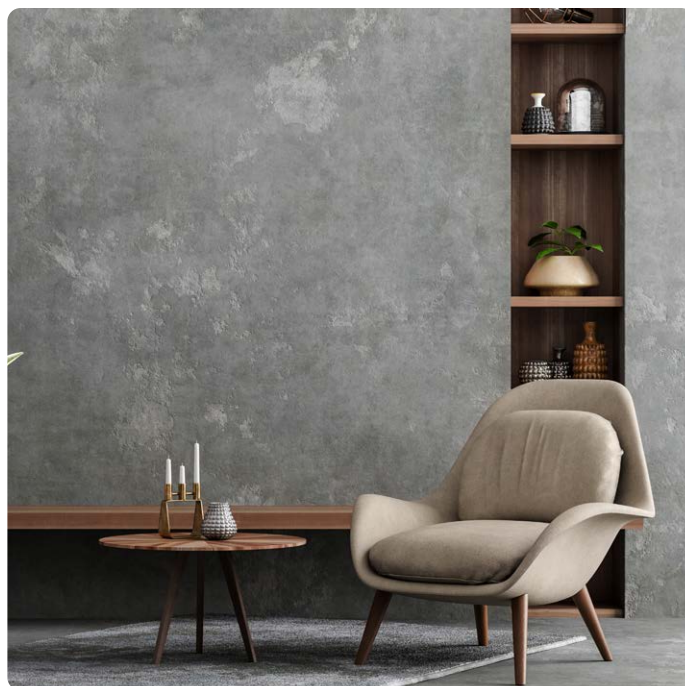

MARIA

BAREVNÉ PROVEDENÍ	ROZTEČ	B	A	C	KÓD
bílá	96	115	8	23	063635
černá	96	115	8	23	063634
	128	156	8	23	391043
chrom lesklý	96	115	8	23	063631
	128	156	8	23	056942
chrom satén	96	115	8	23	063633
	128	156	8	23	063630
mosaz	96	115	8	23	011514
	128	156	8	23	078124
nikl broušený	96	115	8	23	063632
	128	156	8	23	117401
nikl satén	96	115	8	23	011515
	128	156	8	23	097443

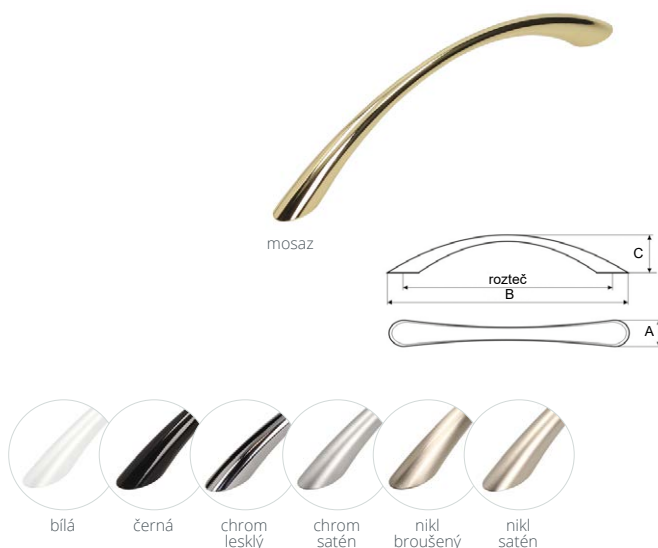

CORIA

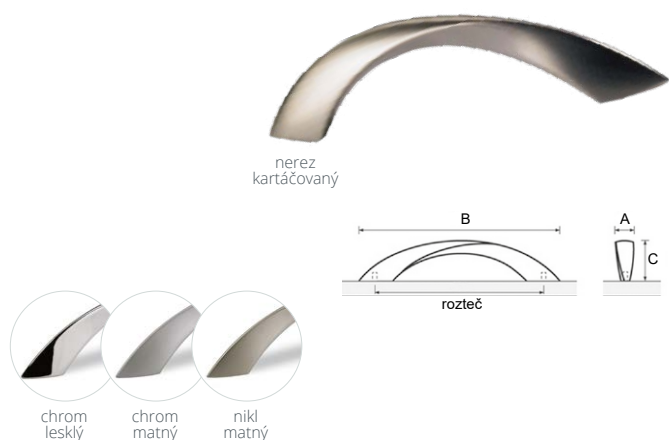

BAREVNÉ PROVEDENÍ	ROZTEČ	B	A	C	KÓD
chrom lesklý	128	151	16	34	714295
chrom matný	128	151	16	34	351151
nerez kartáčovaný	128	151	16	34	344713
nikl matný	128	151	16	34	351150

GABRIELLA

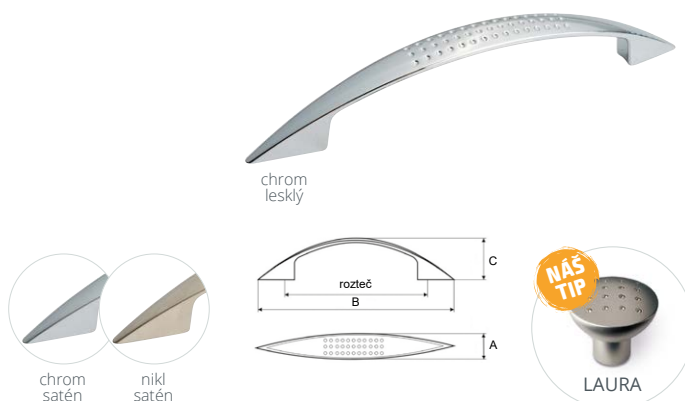

BAREVNÉ PROVEDENÍ	ROZTEČ	B	A	C	KÓD
chrom lesklý	96	132	15	28	063627
	128	164	15	28	042639
chrom satén	96	132	15	28	011460
	128	164	15	28	063628
nikl satén	96	132	15	28	043673
	128	164	15	28	035553

7.1 KOVOVÉ ÚCHYTKY 7 ÚCHYTKY, VĚŠÁKY A PROFILY

JULIE



černá
matná



chrom
lesklý nikl
broušený



BAREVNÉ PROVEDENÍ	ROZTEČ	B	A	C	KÓD
černá matná	160	230	18	27	825687
chrom lesklý	160	230	18	27	825688
nikl broušený	160	230	18	27	825689



GENOA



neroz
finiš



chrom
lesklý



BAREVNÉ PROVEDENÍ	ROZTEČ	B	A	C	KÓD
chrom lesklý	128	170	23	26	160772
neroz finiš	128	170	23	26	160796

LORI



ALU efekt



chrom
lesklý nikl
jemně
broušený

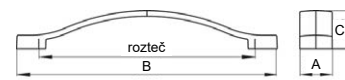

BAREVNÉ PROVEDENÍ	ROZTEČ	B	A	C	KÓD
ALU efekt	160	193	24	28	118448
chrom lesklý	160	193	24	28	571475
nikl jemně broušený	160	193	24	28	117939

ANGELA



chrom
lesklý



chrom
satén nikl
satén

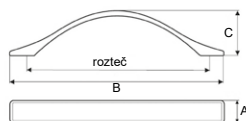

ANGELA

BAREVNÉ PROVEDENÍ	ROZTEČ	B	A	C	KÓD
chrom lesklý	96	115	13	25	365338
chrom satén	96	115	13	25	365340
nikl satén	96	115	13	25	365339

SERENA



chrom
satén

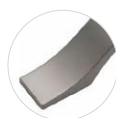

nikl
broušený

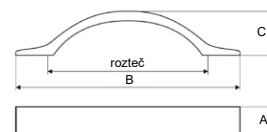

SERENA

BAREVNÉ PROVEDENÍ	ROZTEČ	B	A	C	KÓD
chrom satén	96	140	20	29	217250
nikl broušený	96	140	20	29	365349

7.1 KOVOVÉ ÚCHYTKY

7 ÚCHYTKY, VĚŠÁKY A PROFILY

LINE



ušlechtilá ocel
matná



antracit
matný

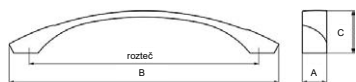

↓ NINA, železo broušené

BAREVNÉ PROVEDENÍ	ROZTEČ	B	A	C	KÓD
antracit matný	160	188	17	29	754617
	320	348	17	30	754615
ušlechtilá ocel matná	160	188	17	29	754616
	320	348	17	30	754614

NINA



černá měď
mosaz ručně broušená
nikl jemně broušený
železo broušené



ušlechtilá
ocel mat



BAREVNÉ PROVEDENÍ	ROZTEČ	B	A	C	KÓD
černá měď	160	180	25	29	875206
	320	340	25	29	870677
mosaz ručně broušená	160	180	25	29	770913
	320	340	25	29	751790
nikl jemně broušený	160	180	25	29	692227
	320	340	25	29	687655
ušlechtilá ocel mat	160	180	25	29	719958
	320	340	25	29	719957
železo broušené	160	180	25	29	737152
	320	340	25	29	707114

SALONA



BAREVNÉ PROVEDENÍ	ROZTEČ	B	A	C	KÓD
nerez finiš	160	180	19	27	351098

DINIA



nerez
finiš



chrom
satén

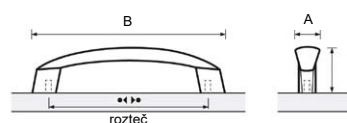

BAREVNÉ PROVEDENÍ	ROZTEČ	B	A	C	KÓD
chrom satén	96	118	16	28	029806
	128	143	18	29	029838
nerez finiš	96	118	16	28	029805
	128	143	18	29	029872

7.1 KOVOVÉ ÚCHYTKY 7 ÚCHYTKY, VĚŠÁKY A PROFILY

ALESSANDRA

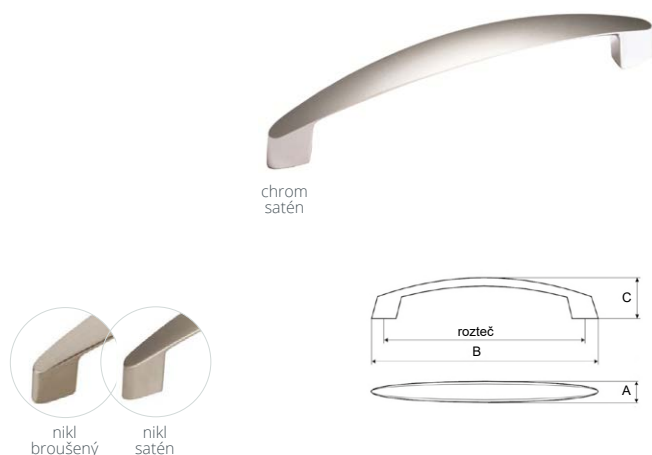

BAREVNÉ PROVEDENÍ	ROZTEČ	B	A	C	KÓD
chrom satén	128	140	17	25	011455
nikl broušený	128	140	17	25	063604
nikl satén	128	140	17	25	011582

BRIGITA

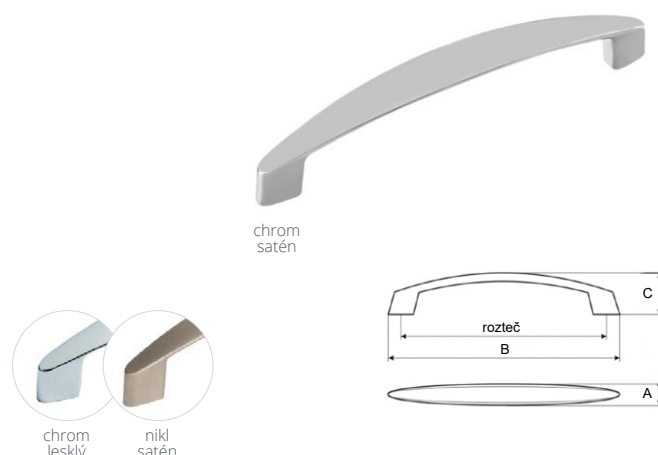

BAREVNÉ PROVEDENÍ	ROZTEČ	B	A	C	KÓD
chrom lesklý	96	108	17	25	063606
chrom satén	96	108	17	25	063607
nikl satén	96	108	17	25	011456

FECTIO

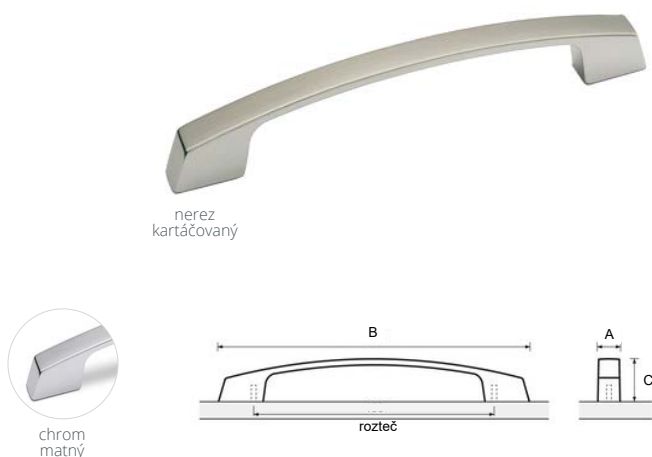

BAREVNÉ PROVEDENÍ	ROZTEČ	B	A	C	KÓD
chrom matný	160	210	15	29	351230
nerez kartáčovaný	160	210	15	29	351231

VANTANIA

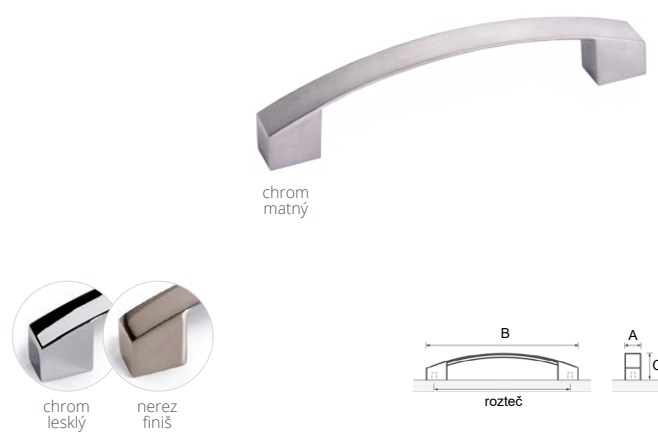

BAREVNÉ PROVEDENÍ	ROZTEČ	B	A	C	KÓD
chrom lesklý	128	144	14	27	350979
chrom matný	128	144	14	27	350990
nerez finiš	128	144	14	27	350989

SIERA

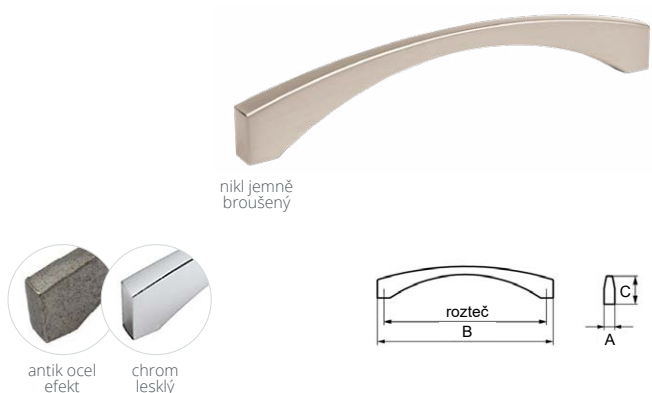

BAREVNÉ PROVEDENÍ	ROZTEČ	B	A	C	KÓD
antik ocel efekt	160	173	12	31	669891
chrom lesklý	320	333	12	31	662423
chrom lesklý	160	173	12	31	414307
chrom lesklý	320	333	12	31	426906
nikl jemně broušený	160	173	12	31	409755
nikl jemně broušený	320	333	12	31	409757



← SIERA, antik ocel efekt

7.1 KOVOVÉ ÚCHYTKY

7 ÚCHYTKY, VĚŠÁKY A PROFILY

VALEDA

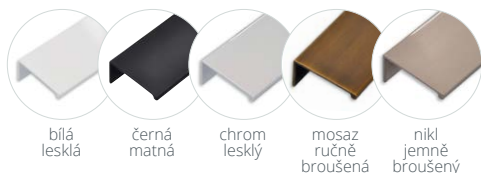

BAREVNÉ PROVEDENÍ	ROZTEČ	B	A	C	KÓD
bílá lesklá	48	70	40	20	763888
	128	145	40	20	787891
černá matná	48	70	40	20	763892
	128	145	40	20	787892
chrom lesklý	288	320	40	20	831575
	48	70	40	20	787897
mosaz ručně broušená	128	145	40	20	762151
	48	70	40	20	787894
nikl jemně broušený	48	70	40	20	755900
	128	145	40	20	787895
železo broušené	48	70	40	20	751451
	128	145	40	20	787896
	288	320	40	20	845230



železo broušené

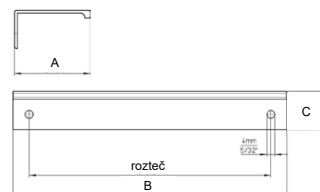

ZITA



nerez antracit světlý



nerez

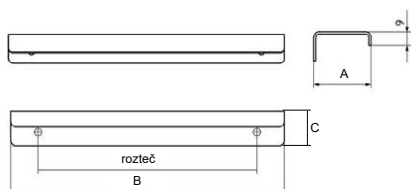

BAREVNÉ PROVEDENÍ	ROZTEČ	B	A	C	KÓD
	16	32	40	20	881411
nerez antracit světlý	64	96	40	20	868204
	160	192	40	20	862348
nerez	16	32	40	20	716126
	64	96	40	20	860030
	160	192	40	20	709488



↓ LEILA, antracit

LEILA



BAREVNÉ PROVEDENÍ	ROZTEČ	B	A	C	KÓD
antracit	160	185	18	23	751480
	320	339	18	24	751476
antracit matný	160	185	18	23	683359
	320	339	18	24	738532
chrom lesklý	160	185	18	23	698446
	320	339	18	24	681674
nikl jemně broušený	160	185	18	23	671386
	320	339	18	24	674187
ušlechtilá ocel efekt	160	185	18	23	674186
	320	339	18	24	693491



antracit

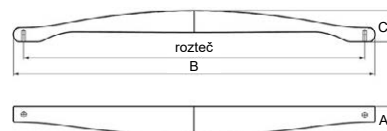

7.1 KOVOVÉ ÚCHYTKY 7 ÚCHYTKY, VĚŠÁKY A PROFILY

KAIRA

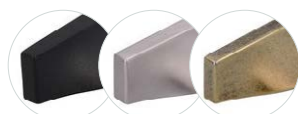

černá matná nikl jemně broušený starozlatá

BAREVNÉ PŘÍMĚŠENÍ	ROZTEČ	B	A	C	KÓD
černá matná	64	94	16	20	787879
	160	190	16	20	787870
	320	350	16	20	787875
nikl jemně broušený	64	94	16	20	787881
	160	190	16	20	787872
	320	350	16	20	787877
starozlatá	64	94	16	20	787882
	160	190	16	20	787873
	320	350	16	20	787878
železo broušené	64	94	16	20	787883
	160	190	16	20	787874



železo broušené

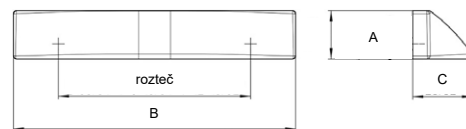

→ VIKI, černá matná

VIKI



černá matná



bílá matná ušlechtilá ocel mat

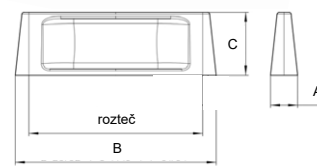

BAREVNÉ PŘÍMĚŠENÍ	ROZTEČ	B	A	C	KÓD
bílá matná	64	74	10	23	859459
	64	74	10	23	859460
černá matná	128	138	10	23	859455
	192	202	10	23	859457
ušlechtilá ocel mat	64	74	10	23	859461
	128	138	10	23	859456
	192	202	10	23	859458

ROVIGO

BAREVNÉ PŘÍMĚŠENÍ	ROZTEČ	B	A	C	KÓD
hliník eloxovaný	64	79	16	25	664650
	96	111	16	25	666623
	128	143	16	25	666625
	160	175	16	25	666627
	192	207	16	25	666629
	224	239	16	25	666631
8x 224 (ke krácení)	2 000	16	25	666633	
chrom lesklý	64	79	16	25	664648
	96	111	16	25	666613
	128	143	16	25	666614
	160	175	16	25	351149
	192	207	16	25	666615
	224	239	16	25	351295
nerez kartáčovaný	64	79	16	25	664649
	96	111	16	25	666617
	128	143	16	25	666619
	160	175	16	25	351112
	192	207	16	25	666621
	224	239	16	25	351205



chrom lesklý

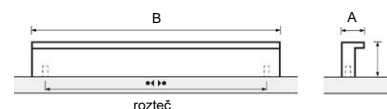

hliník eloxovaný nerez kartáčovaný

7.1 KOVOVÉ ÚCHYTKY

7 ÚCHYTKY, VĚŠÁKY A PROFILY

MEDILA



chrom
lesklý



černá
matná



← MEDILA, chrom lesklý

BAREVNÉ PŘÍKRYTÍ	ROZTEČ	B	A	C	KÓD
černá matná	192	250	10	25	843445
	448	500	10	25	843446
	576/704	760	10	25	836288
chrom lesklý	192	250	10	25	802113
	448	500	10	25	802114
	576/704	760	10	25	802115

ISANA

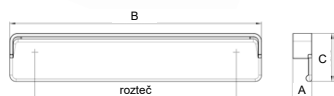

BAREVNÉ PŘÍKRYTÍ	ROZTEČ	B	A	C	KÓD
nikl jemně broušený	128	160	12	30	802088

SÁVA

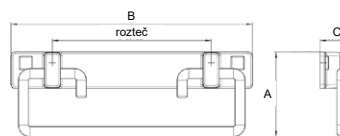

SÁVA

BAREVNÉ PŘÍKRYTÍ	ROZTEČ	B	A	C	KÓD
černá matná	96	146	51	20	787887

RUSTIKÁLNÍ ÚCHYTKY

SPARTA II



nikl patina



mosaz patina
nikl leštěný černý

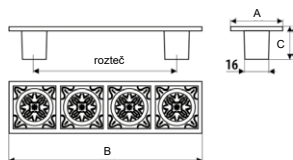

BAREVNÉ PŘÍKLEBY	ROZTEČ	B	A	C	KÓD
mosaz patina	96	130	35	22	861562
nikl leštěný černý	96	130	35	22	861563
nikl patina	96	130	35	22	861561

TORA



grafit
stříbro antik



měď antik

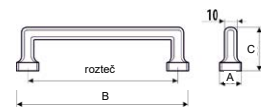

BAREVNÉ PŘÍKLEBY	ROZTEČ	B	A	C	KÓD
grafit	128	146	18	37	853574
	160	178	18	37	853577
	320	338	18	37	853579
měď antik	128	146	18	37	853572
	160	178	18	37	853575
stříbro antik	128	146	18	37	853573
	160	178	18	37	853576



→ ZAIRA, mosaz ručně broušená

ZAIRA



ZAIRA



železo černé patina



cínová
mosaz ručně broušená

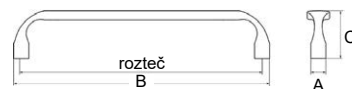

BAREVNÉ PŘÍKLEBY	ROZTEČ	B	A	C	KÓD
cínová	160	170	15	31	787905
mosaz ručně broušená	160	170	15	31	787906
železo černé patina	160	170	15	31	753253

SALACIA



cínová



stříbrná antik

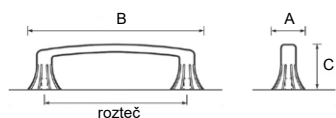

BAREVNÉ PŘÍKLEBY	ROZTEČ	B	A	C	KÓD
cínová	128	151	23	30	351132
stříbrná antik	128	151	23	30	350406

CORDUBA



BAREVNÉ PŘÍKLEBY	ROZTEČ	B	A	C	KÓD
cínová	128	146	18	28	043753

7.2 RUSTIKÁLNÍ ÚCHYTKY 7 ÚCHYTKY, VĚŠÁKY A PROFILY

VIENA

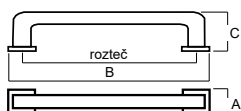

BAREVNÉ PŘÍKRYTÍ	ROZTEČ	B	A	C	KÓD
staromosaz	96	110	13	34	646957
starostříbrná	96	110	13	34	625728

JOLANA

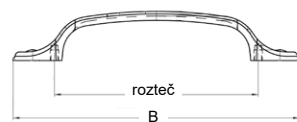

BAREVNÉ PŘÍKRYTÍ	ROZTEČ	B	A	C	KÓD
chrom satén	96	133	20	24	823017
nikl jemně broušený	96	133	20	24	823018
nikl matný	96	133	20	24	823019

ALIDA

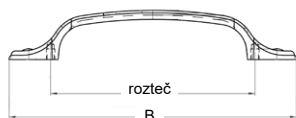

BAREVNÉ PŘÍKRYTÍ	ROZTEČ	B	A	C	KÓD
staromosaz	96	135	13	23	118911

AGLIA

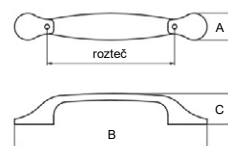

BAREVNÉ PŘÍKRYTÍ	ROZTEČ	B	A	C	KÓD
staromosaz kartáčovaný	96	145	20	22	196411

VERONA

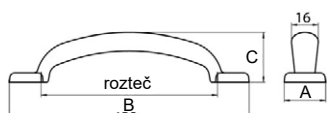

BAREVNÉ PŘÍKRYTÍ	ROZTEČ	B	A	C	KÓD
staromosaz	96	136	20	25	685576
starostříbrná	96	136	20	25	523963

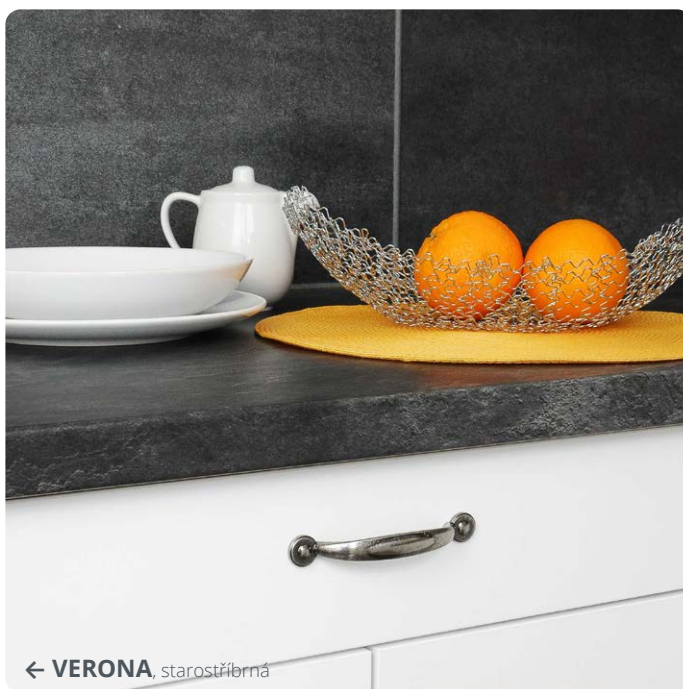

7.2 RUSTIKÁLNÍ ÚCHYTKY 7 ÚCHYTKY, VĚŠÁKY A PROFILY

ADINA



černá matná

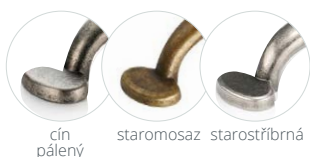

čín pálený staromosaz starostříbrná

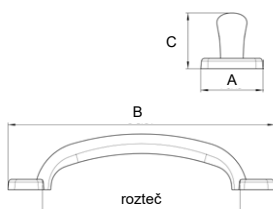

BAREVNÉ PŘÍKRYTÍ	ROZTEČ	B	A	C	KÓD
čín pálený	96	130	30	27	802079
černá matná	96	130	30	27	802078
staromosaz	96	130	30	27	751259
starostříbrná	96	130	30	27	774535

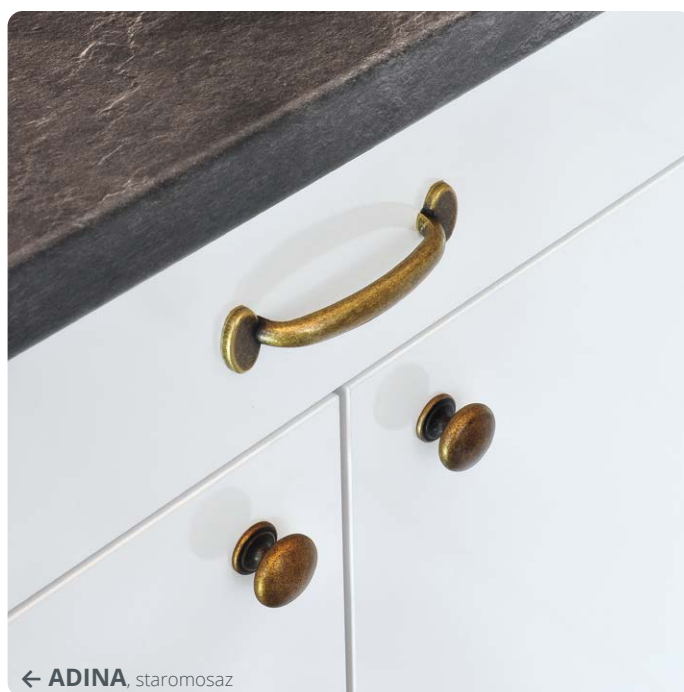

← ADINA, staromosaz

ALBERTA



čín antik



mosaz antik nerez finiš

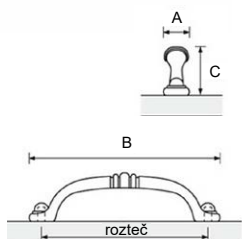

BAREVNÉ PŘÍKRYTÍ	ROZTEČ	B	A	C	KÓD
čín antik	96	110	14	28	350958
mosaz antik	96	110	14	28	350957
nerez finiš	96	110	14	28	350959

ROSA



nikl patina



mosaz patina

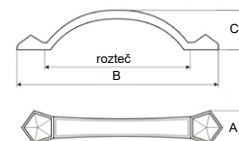

BAREVNÉ PŘÍKRYTÍ	ROZTEČ	B	A	C	KÓD
mosaz patina	96	120	23	25,5	365357
nikl patina	96	120	23	25,5	365358

RITA



mosaz patina



mosaz antik nikl černý / mosaz

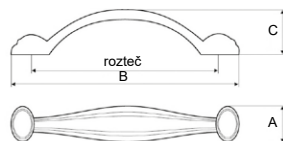

BAREVNÉ PŘÍKRYTÍ	ROZTEČ	B	A	C	KÓD
mosaz patina	96	110	18	22	365359
nikl černý / mosaz	96	110	18	22	674349
nikl patina	96	110	18	22	365360

HAIDA



mosaz antik



nerez finiš

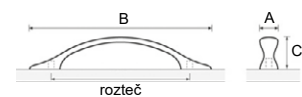

BAREVNÉ PŘÍKRYTÍ	ROZTEČ	B	A	C	KÓD
mosaz antik	96	126	13	22	350882
nerez finiš	96	126	13	22	350907

7.2 RUSTIKÁLNÍ ÚCHYTKY

7 ÚCHYTKY, VĚŠÁKY A PROFILY

STELA

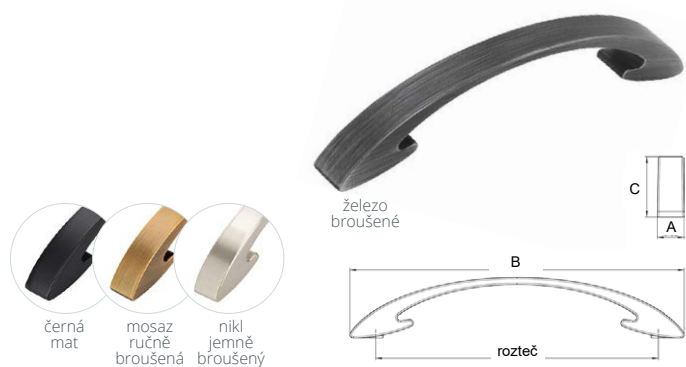

BAREVNÉ PŘÍKRYTÍ	ROZTEČ	B	A	C	KÓD
černá matná	128	151	15	34	859447
	160	189	15	34	859451
mosaz ručně broušená	128	151	15	34	859448
	160	189	15	34	859452
nikl jemně broušený	128	151	15	34	859449
	160	189	15	34	859453
železo broušené	128	151	15	34	859450
	160	189	15	34	859454



EGARA

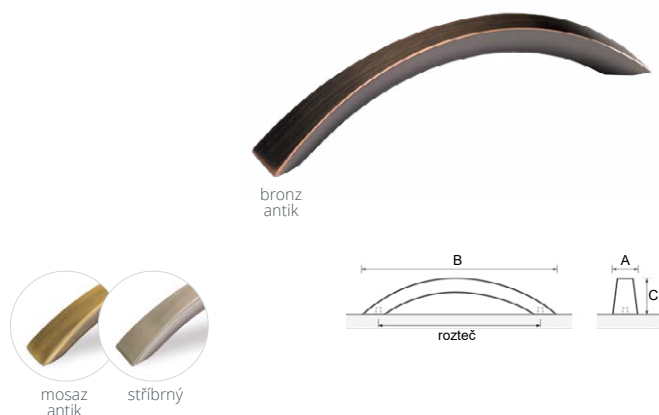

BAREVNÉ PŘÍKRYTÍ	ROZTEČ	B	A	C	KÓD
bronz antik	128	155	20	30	160739
mosaz antik	128	155	20	30	160740
stříbrný antik	128	155	20	30	160741

VESNA

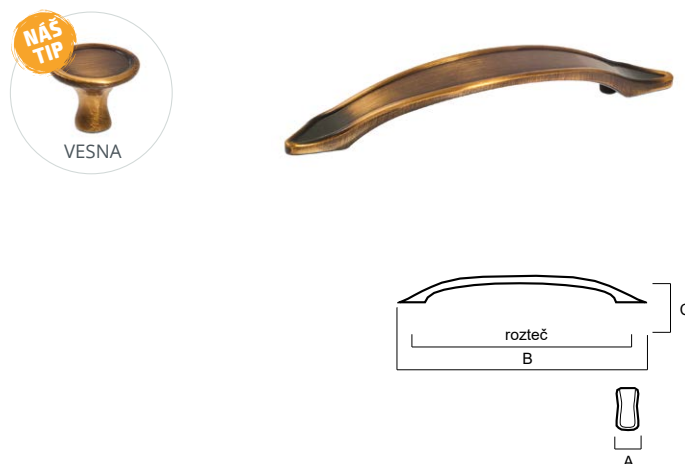

BAREVNÉ PŘÍKRYTÍ	ROZTEČ	B	A	C	KÓD
staromosaz kartáčovaná	96	144	24	24	352669

ALINA



BAREVNÉ PŘÍKRYTÍ	ROZTEČ	B	A	C	KÓD
bronz broušený	128	142	13	26	825672
	160	174	13	26	825673
	320	334	13	26	825674
černá matná	128	142	13	26	825666
	160	174	13	26	825667
	320	334	13	26	825668
chrom lesklý	128	142	13	26	825669
	160	174	13	26	825670
	320	334	13	26	825671
nikl broušený	128	142	13	26	825675
	160	174	13	26	825676
	320	334	13	26	825677

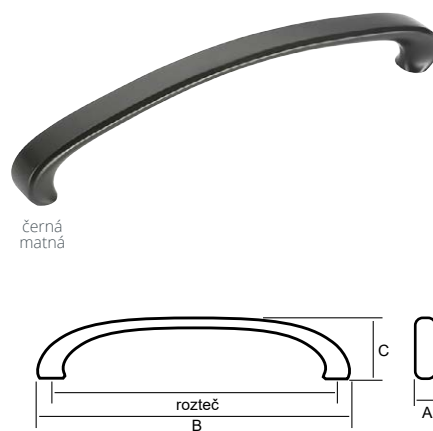

7.2 RUSTIKÁLNÍ ÚCHYTKY

7 ÚCHYTKY, VĚŠÁKY A PROFILY

NATÁLIA



mosaz
lesklá

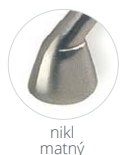

nikl
matný

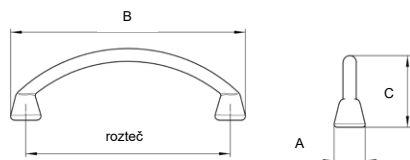

BAREVNÉ PROVEDENÍ	ROZTEČ	B	A	C	KÓD
mosaz lesklá	64	74	10	22	802132
nikl matný	64	74	10	22	802131

RIANA

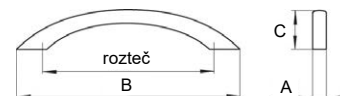

BAREVNÉ PROVEDENÍ	ROZTEČ	B	A	C	KÓD
staromosaz	76	113	14	21	011625

SIENA

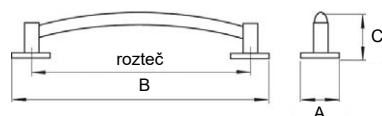

BAREVNÉ PROVEDENÍ	ROZTEČ	B	A	C	KÓD
staromosaz	64	86	22	24	289981
	96	120	25	24	286144

ISABEL



NAŠ TIP
SIMON



staromosaz /
porcelán
s růžovými kvítky



nikl patina /
porcelán
s modrými
kvítky

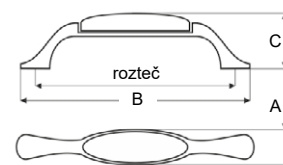

BAREVNÉ PROVEDENÍ	ROZTEČ	B	A	C	KÓD
nikl patina/porcelán s modrými kvítky	96	123	21	31	861560
staromosaz/porcelán s růžovými kvítky	128	168	21	31	861559
staromosaz/porcelán s modrými kvítky	96	123	21	21	861558
staromosaz/porcelán s růžovými kvítky	128	168	21	31	861557

DIVERA II



nikl patina /
porcelán s kvítky



nikl patina/
porcelán

staromosaz/
porcelán
s lístky

staromosaz/
porcelán
popraskaný

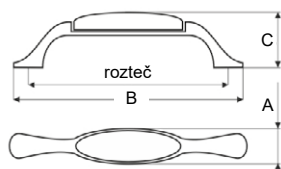

BAREVNÉ PROVEDENÍ	ROZTEČ	B	A	C	KÓD	
porcelán	96	126	19	31	861550	
nikl patina	porcelán s kvítkem	96	126	19	31	861551
	porcelán s lístky	96	126	19	31	861552
	porcelán	96	126	19	31	861553
staromosaz	porcelán popraskaný	96	126	19	31	861556
	porcelán s kvítkem	96	126	19	31	861554
	porcelán s lístky	96	126	19	31	861555

GRETA



NAŠ TIP
SIMON

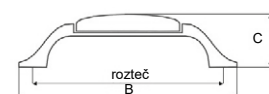

BAREVNÉ PROVEDENÍ	ROZTEČ	B	A	C	KÓD
staromosaz/popraskaný porcelán krémový	96	128	17	28	365355

7.2 RUSTIKÁLNÍ ÚCHYTKY

7 ÚCHYTKY, VĚŠÁKY A PROFILY

MARILIN



MARILIN



staromosaz brinýr /
plast béžový



zinek /
bílý plast

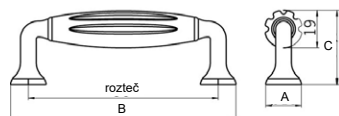

BAREVNÉ PROVEDENÍ	ROZTEČ	B	A	C	KÓD
staromosaz brinýr / plast béžový	96	114	18	37,5	186876
zinek / plast bílý	96	114	18	37,5	492923

ARDENIA II



staromosaz /
porcelán s lístky

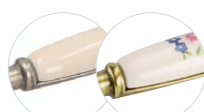

nikl /
porcelán

staromosaz /
porcelán
s kvítky

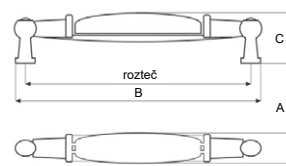

BAREVNÉ PROVEDENÍ	ROZTEČ	B	A	C	KÓD	
porcelán	96	107	17	24	861531	
nikl patina	porcelán s kvítkem	96	107	17	24	861532
	porcelán s lístky	96	107	17	24	861533
	porcelán	96	107	17	24	861535
staromosaz	porcelán popraskaný	96	107	17	24	861538
	porcelán s kvítkem	96	107	17	24	861536
	porcelán s lístky	96	107	17	24	861537

AMELIA



staromosaz



nikl jemně
broušený

ušlechtilá
ocel matná

železo
broušené

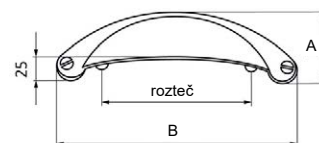

BAREVNÉ PROVEDENÍ	ROZTEČ	B	A	C	KÓD
nikl jemně broušený	64	103	31,5	24,5	294486
staromosaz	64	103	31,5	24,5	286969
ušlechtilá ocel matná	64	103	31,5	24,5	296563
železo broušené	64	103	31,5	24,5	297159

→ AMELIA, železo broušené

7.3 KNOPKY

7 ÚCHYTKY, VĚŠÁKY A PROFILY

KNOPKY

ZAIRA

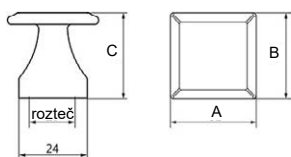

železo černé patina

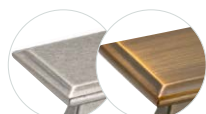

cínová mosaz ručně broušená



ZAIRA

BAREVNÉ PŘÍKRYTÍ	ROZTEČ	B	A	C	KÓD
cínová	16	32	32	30	787863
mosaz ručně broušená	16	32	32	30	779929
železo černé patina	16	32	32	30	771094

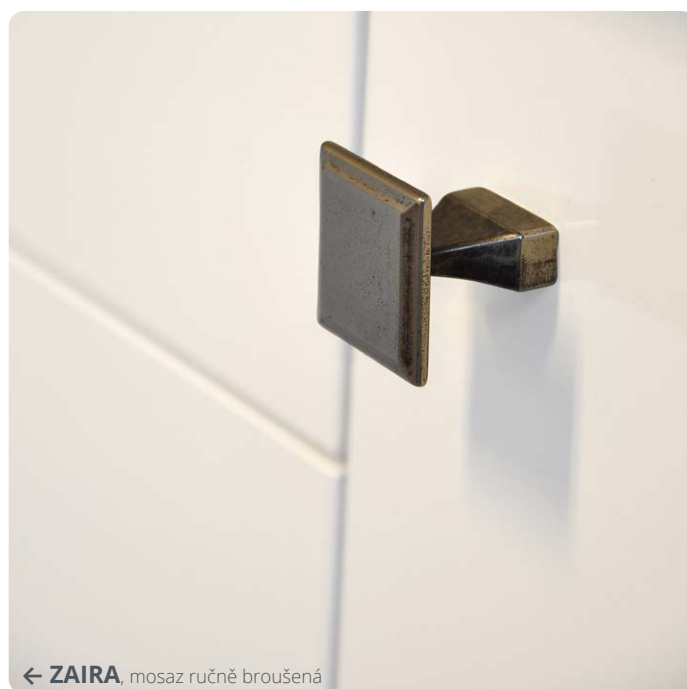

← ZAIRA, mosaz ručně broušená

TORA

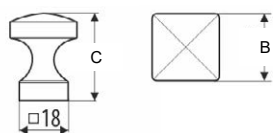

stříbro antik

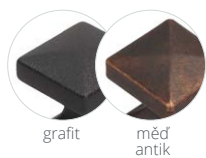

grafit měď antik



TORA

BAREVNÉ PŘÍKRYTÍ	B	A	C	KÓD
grafit	25	25	31	853571
měď antik	25	25	31	853569
stříbro antik	25	25	31	853570

MESSANA

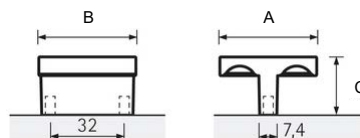

nerez finiš



chrom lesklý

BAREVNÉ PŘÍKRYTÍ	ROZTEČ	B	A	C	KÓD
chrom lesklý	32	42	42	25	160745
nerez finiš	32	42	42	25	159930

ANGELA

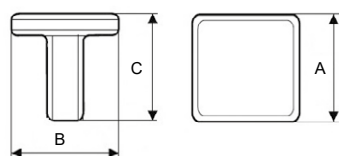

chrom lesklý



chrom satén nikl satén



ANGELA

BAREVNÉ PŘÍKRYTÍ	B	A	C	KÓD
chrom lesklý	20	20	20	365341
chrom satén	20	20	20	365343
nikl satén	20	20	20	365342

SPARTA II

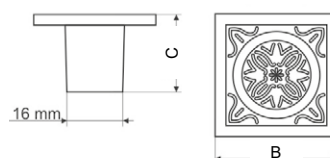

mosaz patina



nikl leštěný černý nikl patina



SPARTA II

BAREVNÉ PŘÍKRYTÍ	B	A	C	KÓD
mosaz patina	35	35	22	861565
nikl leštěný černý	35	35	22	861566
nikl patina	35	35	22	861564

7.3 KNOPKY

7 ÚCHYTKY, VĚŠÁKY A PROFILY

NAVARA

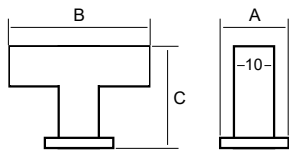

černá matná



chrom lesklý

nikl jemně broušený

BAREVNÉ PŘEVODĚNÍ	B	A	C	KÓD
černá matná	46	18	34	859429
chrom lesklý	46	18	34	859430
nikl jemně broušený	46	18	34	859431



BLOCK

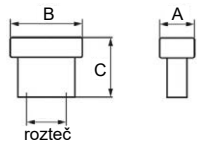

nikl jemně broušený



bílá lesklá

černá matná

chrom lesklý

mosaz jemně broušená

železo broušené

BAREVNÉ PŘEVODĚNÍ	ROZTEČ	B	A	C	KÓD
bílá lesklá	16	29	14	24	787851
černá matná	16	29	14	24	762697
chrom lesklý	16	29	14	24	787852
mosaz ručně broušená	16	29	14	24	787853
nikl jemně broušený	16	29	14	24	116154
železo broušené	16	29	14	24	759727

SÁVA

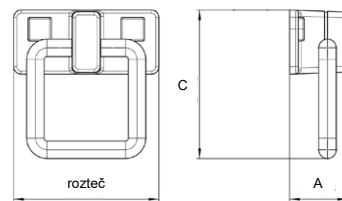

NÁŠ TIP



BAREVNÉ PŘEVODĚNÍ	B	A	C	KÓD
černá matná	51	50	20	787850

QUADROS

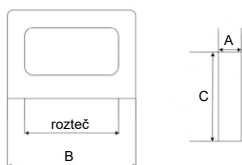

imitace nerezí



hliník

chrom lesklý

NÁŠ TIP



RADOS

BAREVNÉ PŘEVODĚNÍ	ROZTEČ	B	A	C	KÓD
hliník	32	45	8	30	344281
chrom lesklý	32	45	8	30	344282
imitace nerezí	32	45	8	30	344283

NOEMI

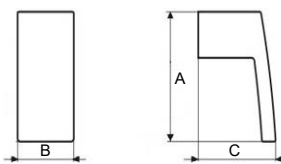

nikl broušený

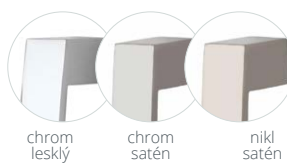

chrom lesklý

chrom satén

nikl satén

NÁŠ TIP



BAREVNÉ PŘEVODĚNÍ	B	A	C	KÓD
chrom lesklý	20	47	28	511015
chrom satén	20	47	28	511017
nikl broušený	20	47	28	754450
nikl satén	20	47	28	511016

SERENA

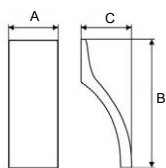

chrom satén



nikl broušený



SERENA

BAREVNÉ PROVEDENÍ	B	A	C	KÓD
chrom satén	70	20	20	365445
nikl broušený	70	20	20	365444

CATARINA

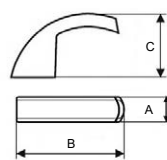

VERONICA

BAREVNÉ PROVEDENÍ	B	A	C	KÓD
nikl broušený	34	8,5	20,6	365354

STELA

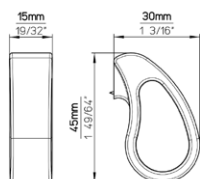

černá matná



mosaz ručně broušená nikl jemně broušený železo broušené



STELA

BAREVNÉ PROVEDENÍ	B	A	C	KÓD
černá matná	45	15	30	859432
mosaz ručně broušená	45	15	30	859433
nikl jemně broušený	45	15	30	859434
železo broušené	45	15	30	859435

INESA

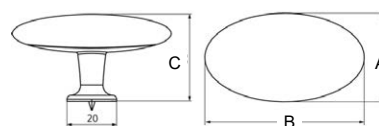

černá matná



antik ocel efekt antracit lesklý rez efekt ušlechtilá ocel mat železo černá patina

BAREVNÉ PROVEDENÍ	B	A	C	KÓD
antik ocel efekt	64	36	35	012009
antracit lesklý	64	36	35	750143
černá matná	64	36	35	787856
rez efekt	64	36	35	709278
ušlechtilá ocel mat	64	36	35	661931
železo černá patina	64	36	35	787857



→ LIMA, nikl jemně broušený

LIMA

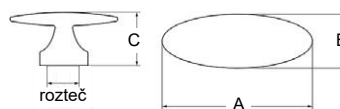

železo broušené



antracit lesklý nikl jemně broušený



LIMA

BAREVNÉ PROVEDENÍ	ROZTEČ	B	A	C	KÓD
antracit lesklý	16	56	20	28	787858
nikl jemně broušený	16	56	20	28	785943
železo broušené	16	56	20	28	751881

7.3 KNOPKY

7 ÚCHYTKY, VĚŠÁKY A PROFILY

ISSA

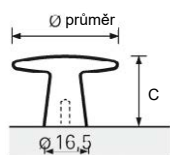

černá matná



chrom lesk nerez kartáčovaný

BAREVNÉ PROVEDENÍ	PRŮMĚR	C	KÓD
černá matná	40	27	808889
chrom lesk	40	27	666591
nerez kartáčovaný	40	27	160725

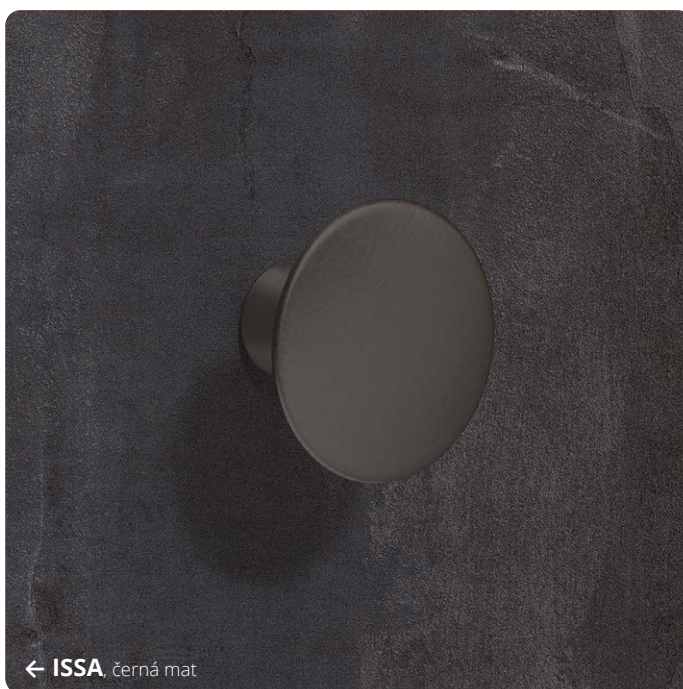

← ISSA, černá mat

VESNA

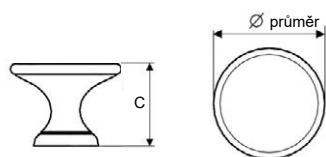

VESNA

BAREVNÉ PROVEDENÍ	PRŮMĚR	C	KÓD
staromosaz kartáčovaná	30	24	360526

AGLIA

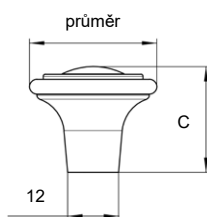

AGLIA

BAREVNÉ PROVEDENÍ	PRŮMĚR	C	KÓD
staromosaz kartáčovaný	30	25	177644

ESSA

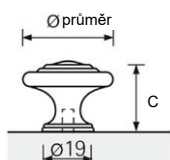

čínová



čínová antik měď antik mosazná antik

BAREVNÉ PROVEDENÍ	PRŮMĚR	C	KÓD
čínová	32	25	350949
čínová antik	32	25	350947
měďená antik	32	25	350950
mosazná antik	32	25	350948

LAURA

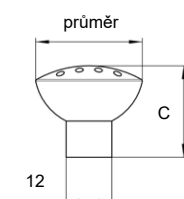

chrom lesklý



chrom satén



LAURA

BAREVNÉ PROVEDENÍ	PRŮMĚR	C	KÓD
chrom lesklý	28	24	011667
chrom satén	28	24	011631

7.3 KNOPKY

7 ÚCHYTKY, VĚŠÁKY A PROFILY

MARILIN

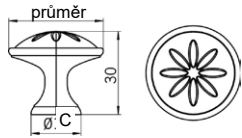

zinek /
plast bílý



staromosaz /
plast béžový



MARILIN

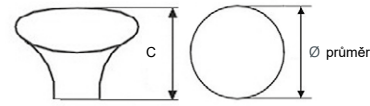

krémový porcelán
popraskaný



bílý
porcelán

BAREVNÉ PŘÍKRYTÍ	PRŮMĚR	C	KÓD
staromosaz brnár/plast béžový	34	30	185948
zinek/plast bílý	34	30	515862

BAREVNÉ PŘÍKRYTÍ	PRŮMĚR	C	KÓD
bílý porcelán	32	23	365366
krémový porcelán popraskaný	32	23	365367

SIMON



nikl patina/
porcelán s
modrými lístky

staromosaz/
popraskaný
porcelán

nikl patina/
porcelán
s kvítkem

staromosaz/
porcelán
s lístky

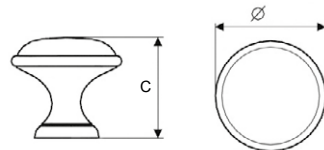

nikl patina /
bílý porcelán

BAREVNÉ PŘÍKRYTÍ	PRŮMĚR	C	KÓD
porcelán bílý	29	24	861539
porcelán bílý s modrými lístky	29	24	861544
porcelán popraskaný	29	24	861542
porcelán s kvítkem	29	24	861540
porcelán s lístky	29	24	861541
porcelán bílý	29	24	861545
porcelán bílý s modrými kvítky	29	24	861548
staromosaz porcelán popraskaný	29	24	365356
porcelán s kvítkem	29	24	861546
porcelán s lístky	29	24	861547



GRETA

ADINA

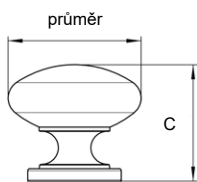

cín pálený



černá
matná

staromosaz

starostříbrná



ADINA

BAREVNÉ PŘÍKRYTÍ	PRŮMĚR	C	KÓD
cín pálený	33	27	805183
černá	33	27	805182
staromosaz	33	27	032618
starostříbrná	33	27	163944

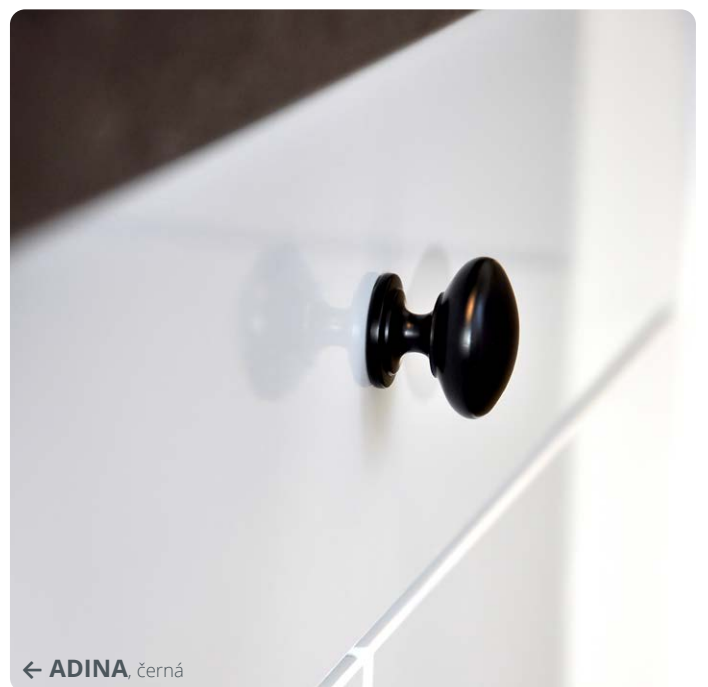

← ADINA, černá

7.3 KNOPKY

7 ÚCHYTKY, VĚŠÁKY A PROFILY

CLEO GRANDE

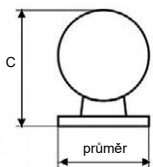

nikl satén

CLEO PICCOLO

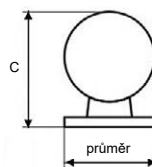

chrom lesklý



chrom lesklý
chrom satén

BAREVNÉ PROVEDENÍ	PRŮMĚR	C	KÓD
chrom lesklý	25	32	047281
chrom satén	25	32	057039
nikl satén	25	32	047282



chrom satén
nikl satén

BAREVNÉ PROVEDENÍ	PRŮMĚR	C	KÓD
chrom lesklý	22	28	034698
chrom satén	22	28	103314
nikl satén	22	28	039627

LENNY

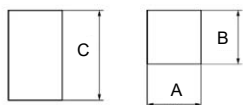

LENNY

BAREVNÉ PROVEDENÍ	B	A	C	KÓD
přírodní elox	15	15	25	710493

VIANA

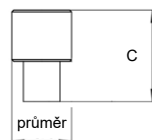

ušlechtilá ocel matná



černá mat
starozlatá



VIANA

BAREVNÉ PROVEDENÍ	PRŮMĚR	C	KÓD
černá matná	16	25	784090
starozlatá	16	25	821477
ušlechtilá ocel matná	16	25	787862

ELLIEN

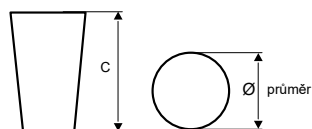

ONEX

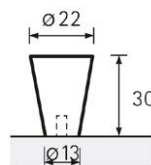

BAREVNÉ PROVEDENÍ	PRŮMĚR	C	KÓD
přírodní elox	20	25	512702

BAREVNÉ PROVEDENÍ	PRŮMĚR	C	KÓD
nerez kartáčovaný	22	30	351052

7.3 KNOPKY

7 ÚCHYTKY, VĚŠÁKY A PROFILY

ALMUS

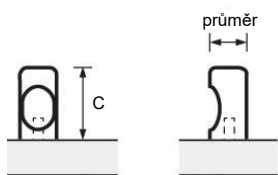

měď lesklá



chrom lesklý

chrom matný

nerez kartáčovaný

nikl satén

BAREVNÉ PŘÍMĚSÍ	PRŮMĚR	C	KÓD
chrom lesklý	12	23	350901
chrom matný	12	23	350903
měď lesklá	12	23	664633
nerez kartáčovaný	12	23	350900
nikl satén	12	23	350902

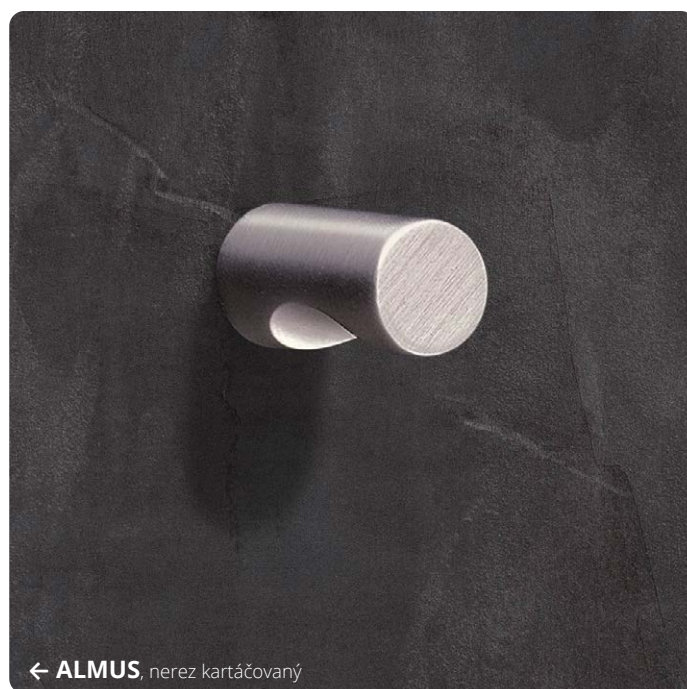

← ALMUS, nerez kartáčovaný

KELLI

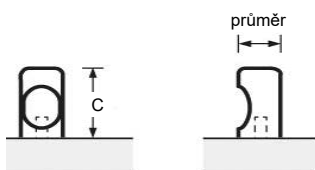

BAREVNÉ PŘÍMĚSÍ	PRŮMĚR	C	KÓD
nerez broušený	18	25	512703

DŘEVĚNÉ ÚCHYTKY

DRIVA

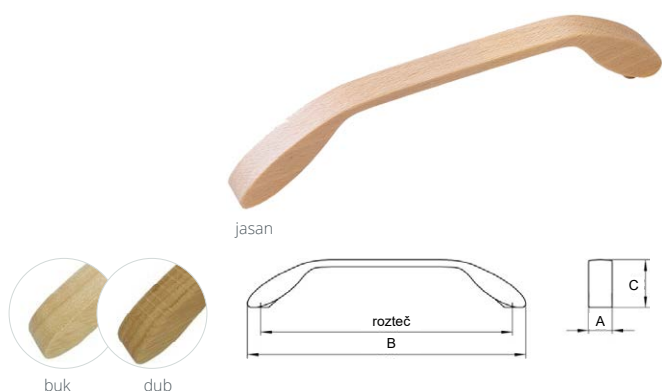

BAREVNÉ PŘÍKRYTÍ	ROZTEČ	B	A	C	KÓD
buk	160	177	15	30	754604
dub	160	177	15	30	754603
jasan	160	177	15	30	754605



ARVIKA

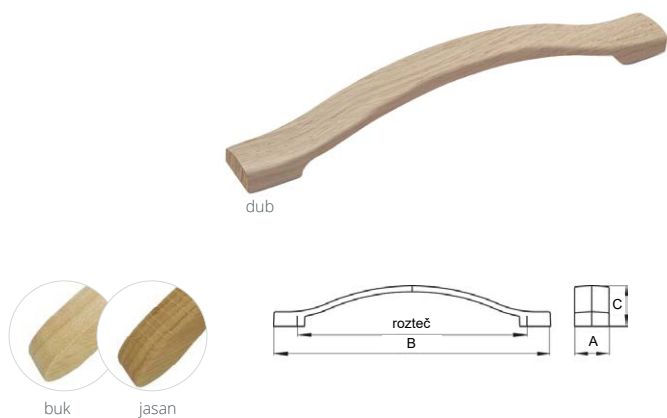

BAREVNÉ PŘÍKRYTÍ	ROZTEČ	B	A	C	KÓD
buk	160	193	24	28	754601
dub	160	193	24	28	754600
jasan	160	193	24	28	754602

MUŠLE

> zádlab d x š x h: 100 x 40 x 13,5 mm

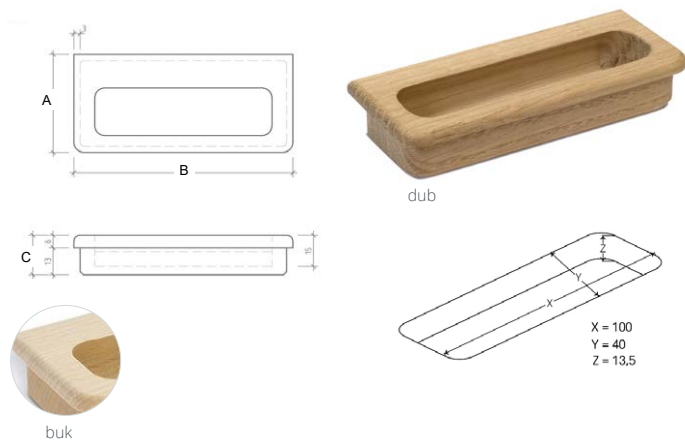

BAREVNÉ PŘÍKRYTÍ	B	A	C	KÓD
buk	105	47	19	011904
dub	105	47	19	011914

VALERIO

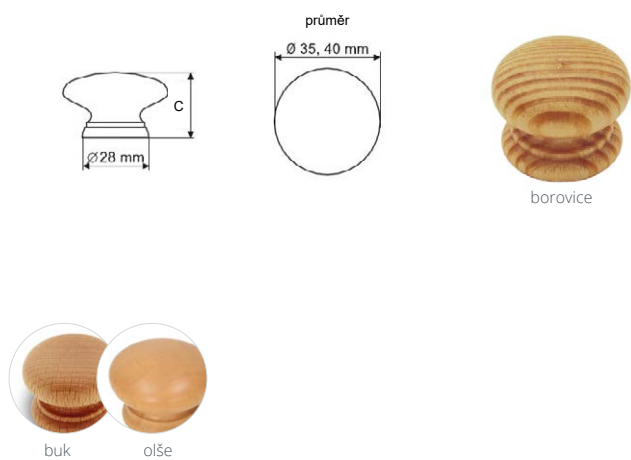

BAREVNÉ PŘÍKRYTÍ	PRŮMĚR	C	KÓD
borovice	35	27	365369
buk	35	27	365368
olše	35	27	365370

KOŽENÉ A JINÉ ÚCHYTKY

DALAS

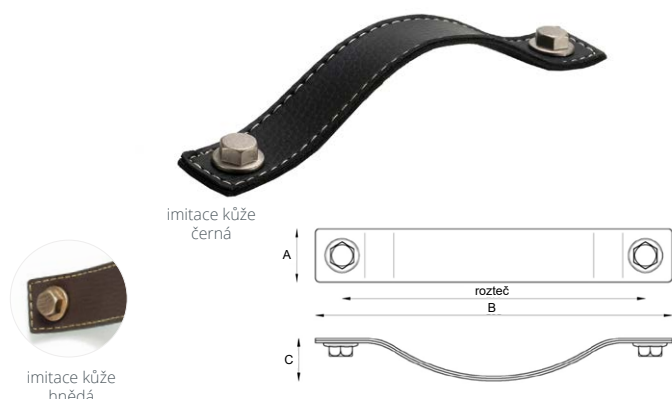

BAREVNÉ PROVEDENÍ	ROZTEČ	B	A	C	KÓD
imitace kůže černá	160	188	28	23	787864
imitace kůže hnědá	160	188	28	23	787865

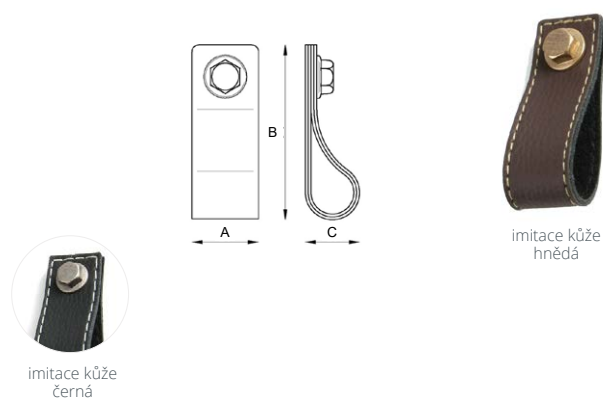

BAREVNÉ PROVEDENÍ	B	A	C	KÓD
imitace kůže černá	74	28	23	787854
imitace kůže hnědá	74	28	23	787855

TEXAS

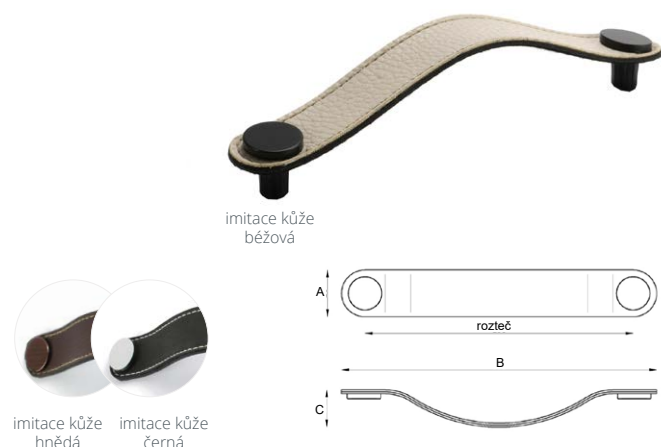

BAREVNÉ PROVEDENÍ	ROZTEČ	B	A	C	KÓD
imitace kůže béžová	160	188	28	23	787888
imitace kůže černá	160	188	28	23	787889
imitace kůže hnědá	160	188	28	23	787890



BAREVNÉ PROVEDENÍ	B	A	C	KÓD
imitace kůže béžová	70	28	23	787859
imitace kůže černá	70	28	23	787860
imitace kůže hnědá	70	28	23	787861

SANTIAGO

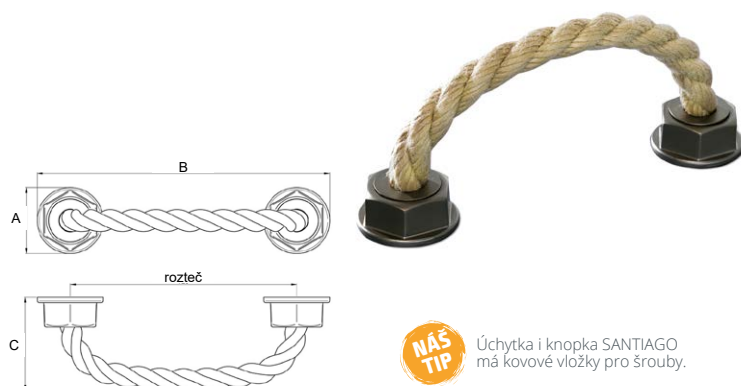

NAŠ TIP Úchytka i knopka SANTIAGO má kovové vložky pro šrouby.

BAREVNÉ PROVEDENÍ	ROZTEČ	B	A	C	KÓD
provozová úchytka	optimálně 64	101	37	50	793135
plastová s flexibilní roztečí	optimálně 128	165	37	50	721488
	optimálně 192	229	37	60	820130

BAREVNÉ PROVEDENÍ	PRŮMĚR	C	KÓD
provozová knopka plastová	37	64	754607

7.6 PLASTOVÉ A DĚTSKÉ ÚCHYTKY, KNOPKY A VĚŠÁKY

7 ÚCHYTKY, VĚŠÁKY A PROFILY

PLASTOVÉ A DĚTSKÉ ÚCHYTKY, KNOPKY A VĚŠÁKY

BOLTA

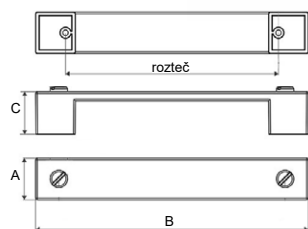

BAREVNÉ PŘÍKRYTÍ	ROZTEČ	B	A	C	KÓD
stříbro antik	128	164	25	25	787516



ELI



bílá matná černá matná tmavě modrá matná žlutá matná

BAREVNÉ PŘÍKRYTÍ	ROZTEČ	B	A	C	KÓD
bílá matná - soft touch	128	140	15	30	861431
	160	172	15	30	861435
	320	332	15	28	861439
černá matná - soft touch	128	140	15	30	850128
	160	172	15	30	850129
	320	332	15	28	850129
starorůžová matná - soft touch	128	140	15	30	861430
	160	172	15	30	861434
	320	332	15	28	861438
tmavě modrá matná - soft touch	128	140	15	30	861428
	160	172	15	30	861432
	320	332	15	28	861436
žlutá matná - soft touch	128	140	15	30	861429
	160	172	15	30	861433
	320	332	15	28	861437

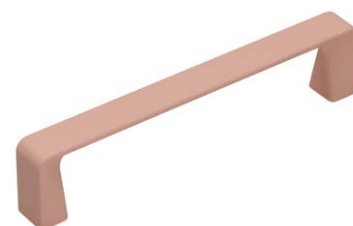

starorůžová matná

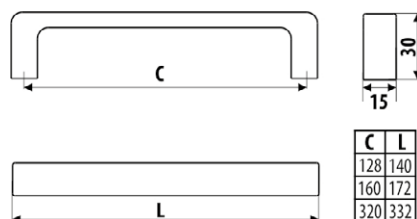

C	L
128	140
160	172
320	332

HONEY



bílá matná černá matná starorůžová matná žlutá matná

BAREVNÉ PŘÍKRYTÍ	ROZTEČ	B	A	C	KÓD
bílá matná - soft touch	128	136	14	30	861459
	160	168	14	30	861464
	320	328	14	30	861469
černá matná - soft touch	128	136	14	30	861458
	160	168	14	30	861463
	320	328	14	30	861468
starorůžová matná - soft touch	128	136	14	30	861457
	160	168	14	30	861462
	320	328	14	30	861467
tmavě modrá matná - soft touch	128	136	14	30	861455
	160	168	14	30	861460
	320	328	14	30	861465
žlutá matná - soft touch	128	136	14	30	861456
	160	168	14	30	861461
	320	328	14	30	861466



tmavě modrá matná

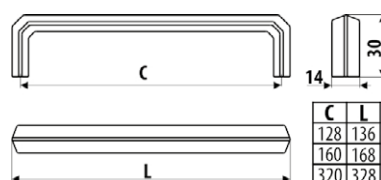

C	L
128	136
160	168
320	328

7.6 PLASTOVÉ A DĚTSKÉ ÚCHYTKY, KNOPKY A VĚŠÁKY

7 ÚCHYTKY, VĚŠÁKY A PROFILY

RUBI



bílá matná černá matná starorůžová matná tmavě modrá matná

BAREVNÉ PŘÍKRYTÍ	ROZTEČ	B	A	C	KÓD
bílá matná - soft touch	128	138	25	28	861444
	160	170	25	28	861449
	320	330	25	28	861454
černá matná - soft touch	128	138	25	28	861443
	160	170	25	28	861448
	320	330	25	28	861453
starorůžová matná - soft touch	128	138	25	28	861442
	160	170	25	28	861447
	320	330	25	28	861452
tmavě modrá matná - soft touch	128	138	25	28	861440
	160	170	25	28	861445
	320	330	25	28	861450
žlutá matná - soft touch	128	138	25	28	861441
	160	170	25	28	861446
	320	330	25	28	861451

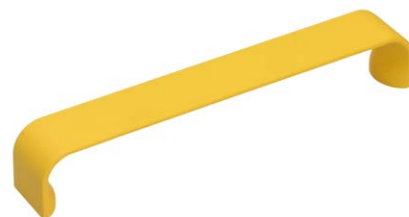

žlutá matná

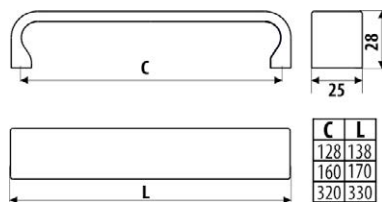

7

LUPO

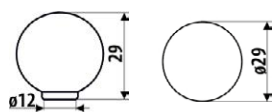

oranžová

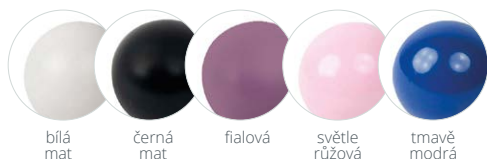

bílá matná černá matná fialová světle růžová tmavě modrá

BAREVNÉ PŘÍKRYTÍ	PRŮMĚR	C	KÓD
bílá matná	29	29	861472
černá matná	29	29	861471
fialová	29	29	861475
oranžová	29	29	861470
světle růžová	29	29	861474
tmavě modrá	29	29	861473

KNOFLÍK

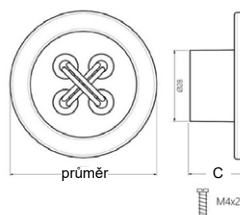

růžová



bílá modrá

BAREVNÉ PŘÍKRYTÍ	PRŮMĚR	C	KÓD
bílá	58	23	754606
modrá	58	23	751253
růžová	58	23	721063

HVĚZDIČKA

> věšák

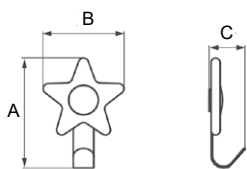

žlutá



modrá růžová

BAREVNÉ PŘÍKRYTÍ	A	B	C	KÓD
modrá	97	71	30	692825
růžová	97	71	30	692824
žlutá	97	71	30	692823

KYTIČKA

> věšák

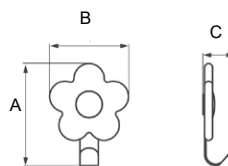

růžová



žlutá

BAREVNÉ PŘÍKRYTÍ	A	B	C	KÓD
růžová	100	77	30	692822
žlutá	100	77	30	692225

ZÁPUSTNÉ ÚCHYTKY

ADRIANA

> zádlab d x š x h: 107 x 31 x 12,5 mm



černá mat chrom lesklý nikl jemně broušený železo broušené

BAREVNÉ PROVEDENÍ	ROZTEČ	B	A	C	KÓD
černá matná	96	112	38	16	753996
chrom lesklý	96	112	38	16	787907
mosaz ručně broušený	96	112	38	16	750435
nikl jemně broušený	96	112	38	16	763765
železo broušené	96	112	38	16	751887



mosaz ručně broušený

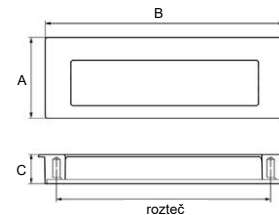
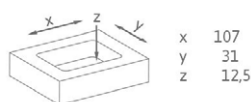

↑ ADRIANA, železo broušené

MONICA II



nikl satén / imitace nerezí



hliník / chrom satén



BAREVNÉ PROVEDENÍ	ROZTEČ	B	A	C	KÓD
hliník/chrom	128	141	43	16	344292
	160	173	43	16	344294
	224	237	43	16	344296
	320	333	43	16	413934
matný chrom/hliník	128	141	43	16	391030
	160	173	43	16	411568
nikl satén/imitace nerezí	128	141	43	16	344293
	160	173	43	16	344295
	224	237	43	16	344297
	320	333	43	16	413935

NIDUM

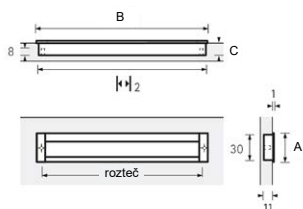

BAREVNÉ PROVEDENÍ	ROZTEČ	B	A	C	KÓD
elox-alu finiš	96	111	35	11	029808
	128	143	35	11	029809
	160	175	35	11	036056
	192	207	35	11	043448
	256	271	35	11	042671
	320	335	35	11	037603

MISNIA



nikl satén



hliník



BAREVNÉ PROVEDENÍ	ROZTEČ	B	A	C	KÓD
hliník	96	116	54	14,5	036042
	160	180	54	14,5	161109
nikl satén	96	116	54	14,5	037246
	160	180	54	14,5	031099

7.7 ZÁPUSTNÉ ÚCHYTKY 7 ÚCHYTKY, VĚŠÁKY A PROFILY

INNA

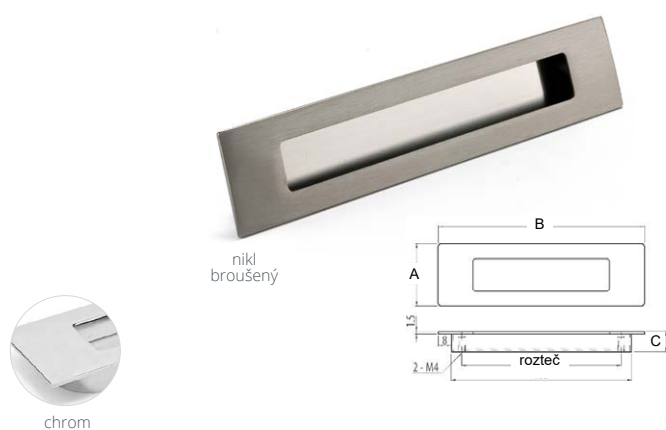

BAREVNÉ PŘÍKRYTÍ	ROZTEČ	B	A	C	KÓD
chrom	96	124	37,5	12,3	569794
	160	186	37,5	12,3	569796
nikl broušený	96	124	37,5	12,3	569795
	160	186	37,5	12,3	569797

VIKTORIE



BAREVNÉ PŘÍKRYTÍ	ROZTEČ	B	A	C	KÓD
chrom	96	110	45	12	031968
	128	142	45	12	122159
	160	174	45	12	581272
chrom satén	96	110	45	12	063592
	128	142	45	12	031967
	160	174	45	12	792693

ENRICO

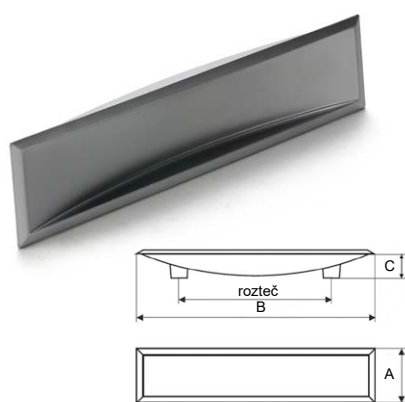

BAREVNÉ PŘÍKRYTÍ	ROZTEČ	B	A	C	KÓD
chrom satén	128	150	34	10	142728



ATHENA

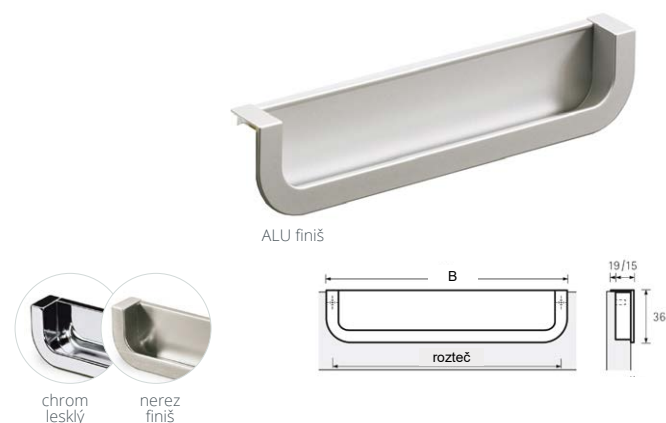

BAREVNÉ PŘÍKRYTÍ	ROZTEČ	B	A	C	KÓD
alu finiš	160	170	33	15	161098
chrom lesklý	160	170	33	15	161127
nerez finiš	160	170	33	15	161214

NIKOLETA

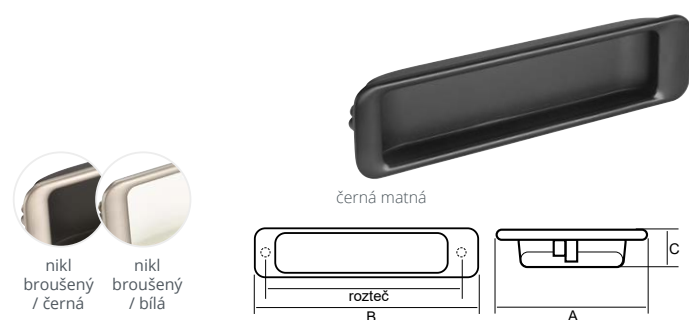

BAREVNÉ PŘÍKRYTÍ	ROZTEČ	B	A	C	KÓD
černá matná	160	173	45	18	825690
	224	237	45	18	825691
	320	377	45	18	825692
nikl broušený/bílá	160	173	45	18	825696
	224	237	45	18	825697
	320	377	45	18	825698
nikl broušený/černá	160	173	45	18	825693
	224	237	45	18	825694
	320	377	45	18	825695

7.8 VĚŠÁKY

7 ÚCHYTKY, VĚŠÁKY A PROFILY

VĚŠÁKY

KANSAS

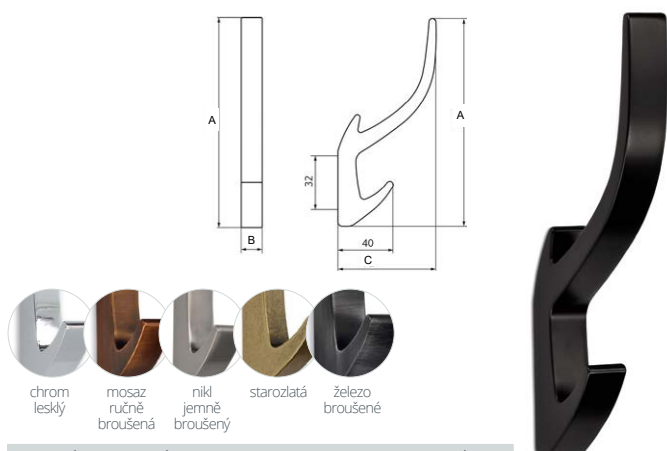

BAREVNÉ PŘÍKRYTÍ	B	A	C	KÓD
černá matná	15	150	71	786678
chrom lesklý	15	150	71	754608
mosaz ručně broušená	15	150	71	750434
nikl jemně broušený	15	150	71	754609
starozlatá	15	150	71	787910
železo broušené	15	150	71	751892

černá matná



BAREVNÉ PŘÍKRYTÍ	B	A	C	KÓD
černá matná	15	81	40	786680
chrom lesklý	15	81	40	754610
mosaz ručně broušená	15	81	40	754612
nikl jemně broušený	15	81	40	751065
starozlatá	15	81	40	787909
železo broušené	15	81	40	754611

mosaz ručně broušená

TOMAS

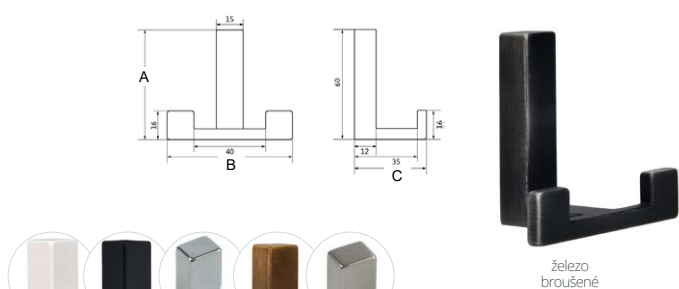

BAREVNÉ PŘÍKRYTÍ	B	A	C	KÓD
bílá lesklá	70	60	40	742426
černá matná	70	60	40	753279
chrom lesklý	70	60	40	642105
mosaz ručně broušená	70	60	40	873841
nikl jemně broušený	70	60	40	559840
železo broušené	70	60	40	718926

železo broušené

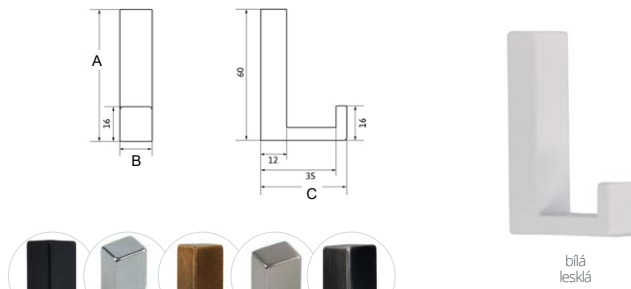

BAREVNÉ PŘÍKRYTÍ	B	A	C	KÓD
bílá lesklá	15	60	40	787911
černá matná	15	60	40	740137
chrom lesklý	15	60	40	633279
mosaz ručně broušená	15	60	40	873837
nikl jemně broušený	15	60	40	570824
železo broušené	15	60	40	752349

bílá lesklá



↑ TOMAS, černá matná, bílá lesklá

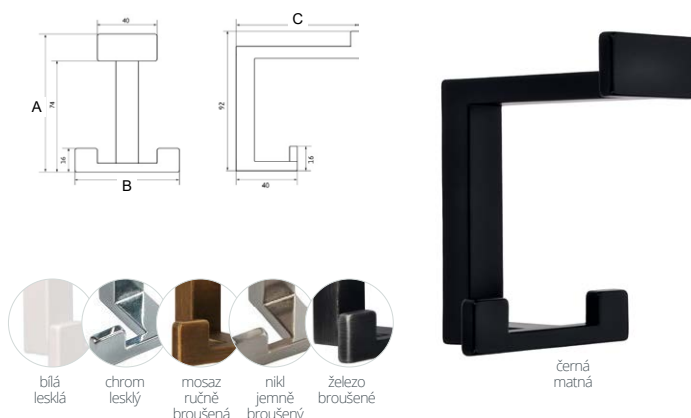

BAREVNÉ PŘÍKRYTÍ	B	A	C	KÓD
bílá lesklá	70	92	80	771030
černá matná	70	92	80	738080
chrom lesklý	70	92	80	572007
mosaz ručně broušená	70	92	80	835793
nikl jemně broušený	70	92	80	559814
železo broušené	70	92	80	711533

černá matná

7.8 VĚŠÁKY

7 ÚCHYTKY, VĚŠÁKY A PROFILY

AYA

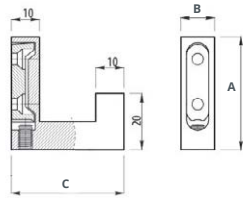

nikl
broušený

chrom



černá
matná

BAREVNÉ PROVEDENÍ	B	A	C	KÓD
černá matná	12	40	40	885707
chrom	12	40	40	512049
nikl broušený	12	40	40	512050

CORA

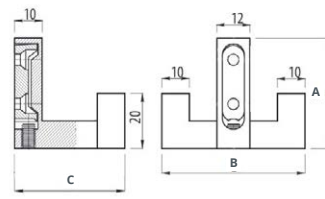

chrom

černá
matná



nikl
broušený

BAREVNÉ PROVEDENÍ	B	A	C	KÓD
černá matná	52	40	40	885708
chrom	52	40	40	512051
nikl broušený	52	40	40	512052

FLINT

> zádlab d x š x h: 174 x 10 x 13 mm

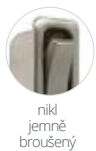
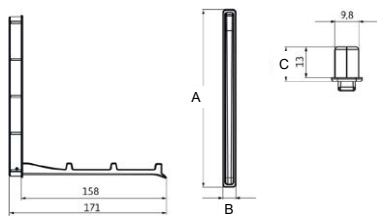

nikl
jemně
broušený



chrom
lesklý

BAREVNÉ PROVEDENÍ	B	A	C	KÓD
chrom lesklý	13	177	14,5	664311
nikl jemně broušený	13	177	14,5	683318

> zádlab d x š x h: 90 x 10 x 13 mm

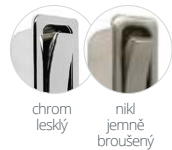
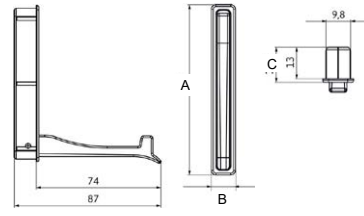

chrom
lesklý

nikl
jemně
broušený



černá
matná

BAREVNÉ PROVEDENÍ	B	A	C	KÓD
černá matná	13	93	14,5	787908
chrom lesklý	13	93	14,5	681577
nikl jemně broušený	13	93	14,5	683131

VIANA

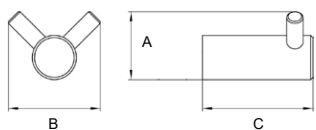

černá
matná



ušlechtilá
ocel
mat



VIANA



VIANA

BAREVNÉ PROVEDENÍ		B	A	C	KÓD
černá matná	dvojitý	26	34	40	787912
	jednoduchý	30	16	40	855661
ušlechtilá ocel mat	dvojitý	26	34	40	787913



↑ FLINT, černá matná

7.8 VĚŠÁKY

7 ÚCHYTKY, VĚŠÁKY A PROFILY

DENVER

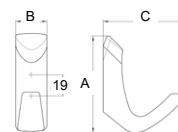
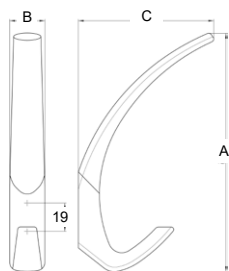

BAREVNÉ PROVEDENÍ	B	A	C	KÓD
hliník/chrom lesk	24	160	90	802072

BAREVNÉ PROVEDENÍ	B	A	C	KÓD
hliník/chrom lesk	24	73	64	802073

TOLEDO

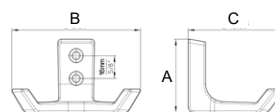
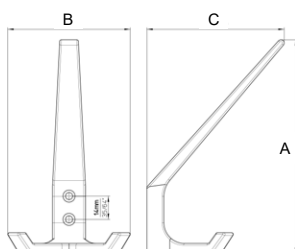

BAREVNÉ PROVEDENÍ	B	A	C	KÓD
hliník lesklý	76	130	57	215815

BAREVNÉ PROVEDENÍ	B	A	C	KÓD
hliník lesklý	78	43	82,5	345154

FABIO

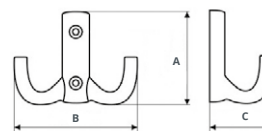
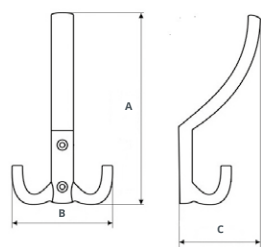

BAREVNÉ PROVEDENÍ	B	A	C	KÓD
černá matná	78	144	60	850799
chrom	78	144	60	063669
chrom satén	78	144	60	063671
nikl broušený	78	144	60	794993
nikl satén	78	144	60	063670

BAREVNÉ PROVEDENÍ	B	A	C	KÓD
černá matná	78	58	30	850797
chrom	78	58	30	063665
chrom satén	78	58	30	063667
nikl broušený	78	58	30	794994
nikl satén	78	58	30	063666

7.8 VĚŠÁKY

7 ÚCHYTKY, VĚŠÁKY A PROFILY

MARCO



BAREVNÉ PROVEDENÍ	B	A	C	KÓD
černá matná	78	144	60	850801
chrom lesklý	78	144	60	063645
chrom satén	78	144	60	063647
nikl satén	78	144	60	063646

BAREVNÉ PROVEDENÍ	B	A	C	KÓD
černá matná	78	58	30	850800
chrom lesklý	78	58	30	063655
chrom satén	78	58	30	063663
nikl satén	78	58	30	063656

TEXON



BAREVNÉ PROVEDENÍ	B	A	C	KÓD
bílá lesklá	19	120	75	794342
černá matná	19	120	75	724055

BAREVNÉ PROVEDENÍ	B	A	C	KÓD
bílá lesklá	19	55	38	794357
černá matná	19	55	38	739039

KUBO



BAREVNÉ PROVEDENÍ	B	A	C	KÓD
černá (plast)	57	150	96	823009
hnědá (plast)	57	150	96	823010
nikl (plast)	57	150	96	823012
tmavě hnědá (plast)	57	150	96	823011

BAREVNÉ PROVEDENÍ	B	A	C	KÓD
černá (plast)	57	62	62	823013
hnědá (plast)	57	62	62	823014
nikl (plast)	57	62	62	823016
tmavě hnědá (plast)	57	62	62	823015

7.8 VĚŠÁKY

7 ÚCHYTKY, VĚŠÁKY A PROFILY

LINA

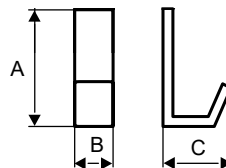
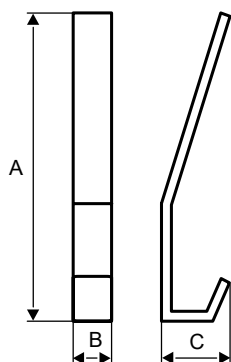

BAREVNÉ PROVEDENÍ	B	A	C	KÓD
nerez broušený	20	142	65	512705

BAREVNÉ PROVEDENÍ	B	A	C	KÓD
nerez broušený	20	60	45	512706

PIETRO

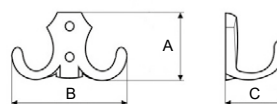
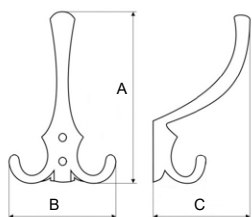

BAREVNÉ PROVEDENÍ	B	A	C	KÓD
černá matná	78	125	70	850803
chrom	78	125	70	012099
chrom satén	78	125	70	063674
nikl satén	78	125	70	012026
starosmosaz	78	125	70	012027

BAREVNÉ PROVEDENÍ	B	A	C	KÓD
černá matná	78	46	30	850802
chrom	78	46	30	012022
chrom satén	78	46	30	063675
nikl satén	78	46	30	012023
starosmosaz	78	46	30	012024

PEDRO

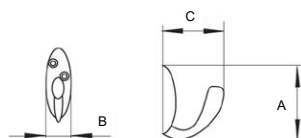
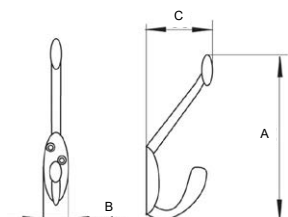

BAREVNÉ PROVEDENÍ	B	A	C	KÓD
černá matná	17,5	88	56	860122
chrom lesklý	17,5	88	56	754613
nikl matný	17,5	88	56	497260

BAREVNÉ PROVEDENÍ	B	A	C	KÓD
černá matná	18	43	38	860123
chrom lesklý	18	43	38	121266
nikl matný	18	43	38	417787

7.8 VĚŠÁKY

7 ÚCHYTKY, VĚŠÁKY A PROFILY

ISIS

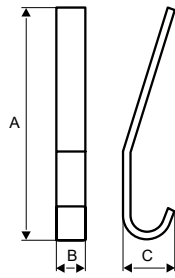

BAREVNÉ PROVEDENÍ	B	A	C	KÓD
přírodní elox	18	175	50	512707

PAOLO

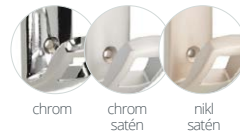
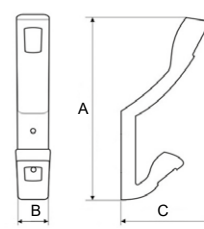

BAREVNÉ PROVEDENÍ	B	A	C	KÓD
chrom	23	152	70	346320
chrom satén	23	152	70	135027
nikl broušený	23	152	70	459293
nikl satén	23	152	70	042493

WITARA II

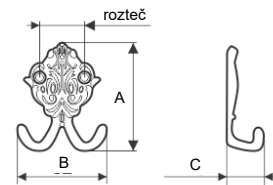
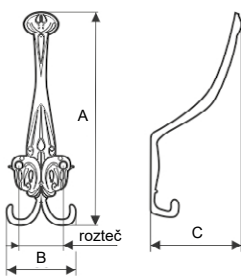

BAREVNÉ PROVEDENÍ	ROZTEČ	B	A	C	KÓD
staromosaz	29	56	15	68	861570

BAREVNÉ PROVEDENÍ	ROZTEČ	B	A	C	KÓD
staromosaz	28	52	63	20	861571

SOTERA

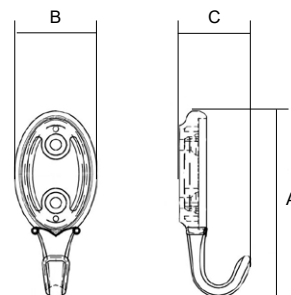
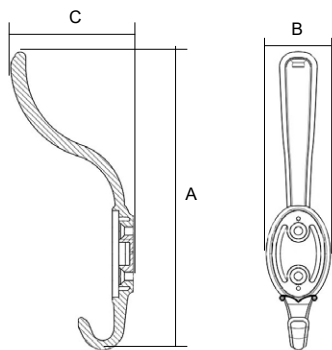

BAREVNÉ PROVEDENÍ	B	A	C	KÓD
staromosaz / plast béžový	34	158	66	411140

BAREVNÉ PROVEDENÍ	B	A	C	KÓD
staromosaz / plast béžový	34	77	29	569818

7.8 VĚŠÁKY

7 ÚCHYTKY, VĚŠÁKY A PROFILY

POLO

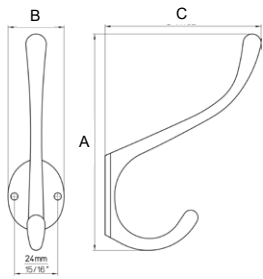

hliník
leštěný

BAREVNÉ PŘÍKRYTÍ	ROZTEČ	B	A	C	KÓD
bílá lesklá	24	33	120	86	787933
černá matná	24	33	120	86	787934
hliník leštěný	24	33	120	86	787935

ANTONIO

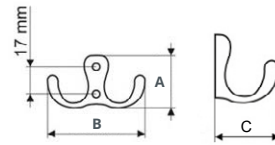

černá
matná

BAREVNÉ PŘÍKRYTÍ	B	A	C	KÓD
černá	56	30	30	660661
chrom	56	30	30	012068
chrom satén	56	30	30	012070
mosaz	56	30	30	029027
nikl satén	56	30	30	012077

SPARTA II

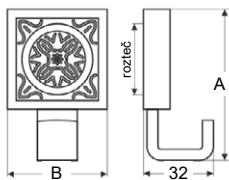

mosaz patina



NIA

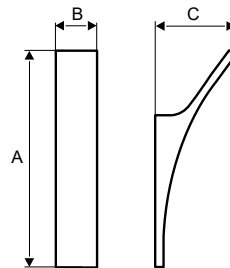

nikl broušený

BAREVNÉ PŘÍKRYTÍ	ROZTEČ	B	A	C	KÓD
mosaz patina	32	45	68	32	861568
nikl leštěný černý	32	45	68	32	861569
nikl patina	32	45	68	32	861567

BAREVNÉ PŘÍKRYTÍ	B	A	C	KÓD
chrom	19	72	24	512053
nikl broušený	19	72	24	512054

ALTIS

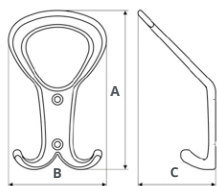

nikl
leštěný

BAREVNÉ PŘÍKRYTÍ	B	A	C	KÓD
chrom satén	70	113	55	492966
nikl leštěný	70	113	55	492961
nikl satén	70	113	55	492962

NAVY

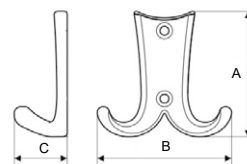

chrom
satén

BAREVNÉ PŘÍKRYTÍ	B	A	C	KÓD
chrom satén	63	59	25	492958
nikl leštěný	63	59	25	492959
nikl satén	63	59	25	492960

PROFILOVÉ ÚCHYTKY

LAMEZIA

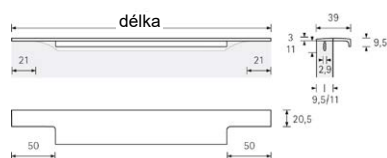

BAREVNÉ PŘÍKRYTÍ	DĚLKA	KÓD
černá matná	295	808892
	345	808894
	395	808896
	445	808898
	495	808900
	595	808902
	795	
	895	808906
	995	808908
	1195	808890
hliník	295	317350
	345	317351
	395	317352
	445	317353
	495	317354
	595	317355
	795	317356
	895	317357
	995	317358
	1195	317359
chrom lesklý	295	317360
	345	317361
	395	317362
	445	317363
	495	317364
	595	317365
	795	317366
	895	317367
	995	317368
	1195	317369
nerez broušený	295	317370
	345	317371
	395	317372
	445	317373
	495	317374
	595	317375
	795	317376
	895	317377
	995	317378
	1195	317379
zlatá kartáčovaná	295	808893
	345	808895
	395	808897
	445	
	495	
	595	808903
	795	808905
895		
995		
1195		

SIMIA

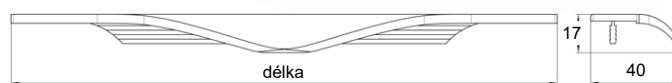

nerezová ocel efekt

BAREVNÉ PŘÍKRYTÍ	DĚLKA	KÓD
černá matná	245	794933
	295	794935
	345	794937
	395	794939
	445	794941
	495	794943
	545	794945
	595	794947
	695	794949
	795	794951
nerezová ocel efekt	895	794953
	995	794955
	1 095	794957
	1 195	794959
	245	794932
	295	794934
	345	794936
	395	794938
	445	794940
	495	794942
545	794944	
595	794946	
695	794948	
795	794950	
895	794952	
995	794954	
1 095	794956	
1 195	794958	

THEA



nerezová ocel efekt

BAREVNÉ PŘÍKRYTÍ	DĚLKA	KÓD
černá matná	295	802158
	395	802159
	495	802160
	595	802162
	695	802129
	795	802163
	895	802165
	995	802167
	295	802157
	395	789917
nerezová ocel efekt	495	789918
	595	802161
	695	802128
	795	789920
	895	802164
	995	802166

PROFILOVÉ ÚCHYTKY

Profilové úchytky jsou velmi oblíbené pro svou čistou linii. Úchytky se montují **naražením do hrany dvířek** do předem vyfrézované drážky.

V naší nabídce naleznete již **hotové úchytky s přesným rozměrem v délkách od 196 do 1 196 mm a s odřezaným stromečkem** k naražení do dvířek, případně s odřezovaným úchytem s přesně definovaným rádiusem vybrání úchyty. **Profilové úchytky lze rovněž připravit na míru** v libovolné délce až 6 m.



lakování
RAL

Všechny profilové úchytky lze lakovat do libovolné barvy dle dostupného RAL vzorníku.



lakování
IGP

V rámci lakování nabízíme rovněž vysoce odolný povrch IGP v černé barvě. Tato barva vyniká stálostí barvy, odolností vůči UV záření a je rovněž otěru odolná.

UK 2

- > materiál hliník
- > barva hliník, černá matná



lakování
RAL



lakování
IGP

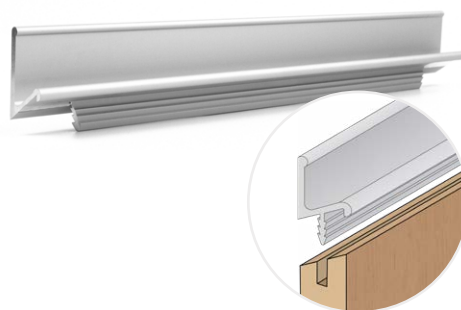
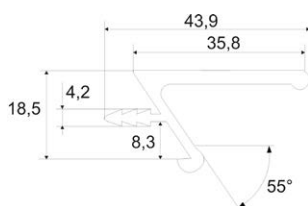

BARVA / DÉLKA (MM)	196	246	296	346	396	446	496	546	596	696	796	896	996	1 196
hliník	793648	793649	793650	793651	793652	793653	793654	793655	793656	793657	793658	793659	793660	793661
černá matná	793662	793663	793664	793665	793666	793667	793668	793669	793670	793671	793672	793673	793674	793675

UK 4

- > materiál hliník
- > barva hliník, černá matná



lakování
RAL



lakování
IGP

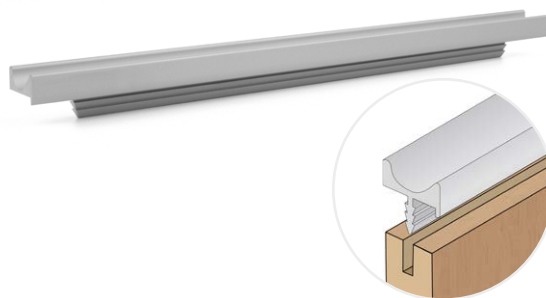
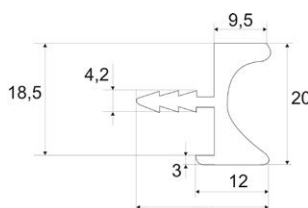

BARVA / DÉLKA (MM)	196	246	296	346	396	446	496	546	596	696	796	896	996	1 196
hliník	793676	793677	793678	793679	793680	793681	793682	793683	793684	793685	793686	793687	793688	793689
černá matná	793690	793691	793692	793693	793694	793695	793696	793697	793698	793699	793700	793701	793702	793703

UK 5

- > materiál hliník
- > barva hliník, nerez, černá matná



lakování
RAL



lakování
IGP

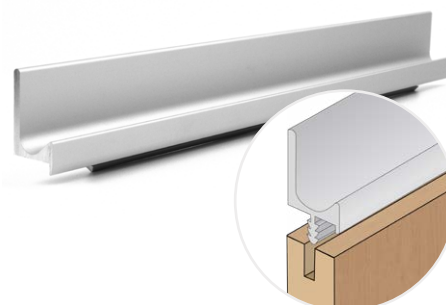
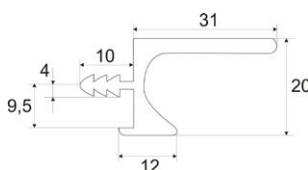

BARVA / DÉLKA (MM)	196	246	296	346	396	446	496	546	596	696	796	896	996	1 196
hliník	793704	793705	793706	793707	793708	793709	793710	793711	793712	793713	793714	793715	793716	793717
nerez	793718	793719	793720	793721	793722	793723	793724	793725	793726	793727	793728	793729	793730	793731
černá matná	793732	793733	793734	793735	793736	793737	793738	793739	793740	793741	793742	793743	793744	793745

UK 7

- > materiál hliník
- > barva hliník, nerez, nerez lakovaný, černá

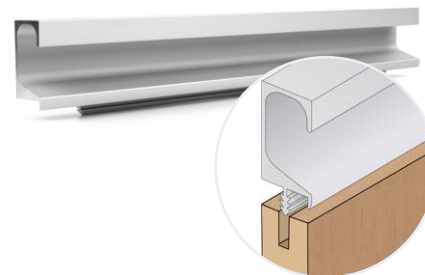
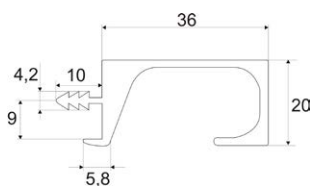

BARVA / DÉLKA (MM)	196	246	296	346	396	446	496	546	596	696	796	896	996	1 196
hliník	793774	793775	793776	793777	793778	793779	793780	793781	793782	793783	793784	793785	793786	793787
nerez	793788	793789	793790	793791	793792	793793	793794	793795	793796	793797	793798	793799	793800	793801
nerez lakovaný	793802	793803	793804	793805	793806	793807	793808	793809	793810	793811	793812	793813	793814	793815
černá	793816	793817	793818	793819	793820	793821	793822	793823	793824	793825	793826	793827	793828	793829

UK 8

- > materiál hliník
- > barva hliník, světlý nerez, tmavý nerez, chrom, černá

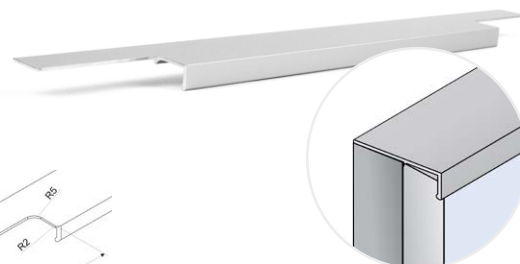
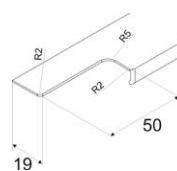
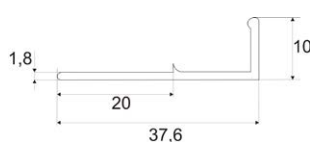
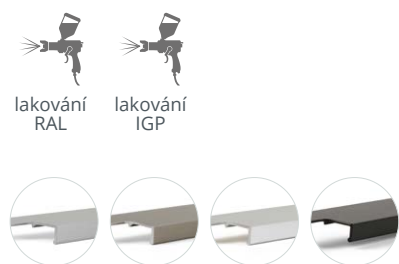

BARVA / DÉLKA (MM)	196	246	296	346	396	446	496	546	596	696	796	896	996	1 196
hliník	793830	793831	793832	793833	793834	793835	793836	793837	793838	793839	793840	793841	793842	793843
nerez světlý	793872	793873	793874	793875	793876	793877	793878	793879	793880	793881	793882	793883	793884	793885
nerez tmavý	793886	793887	793888	793889	793890	793891	793892	793893	793894	793895	793896	793897	793898	793899
chrom	793844	793845	793846	793847	793848	793849	793850	793851	793852	793853	793854	793855	793856	793857
černá	793858	793859	793860	793861	793862	793863	793864	793865	793866	793867	793868	793869	793870	793871

UK 8 N

- > materiál hliník
- > barva hliník, světlý nerez, tmavý nerez, chrom, černá

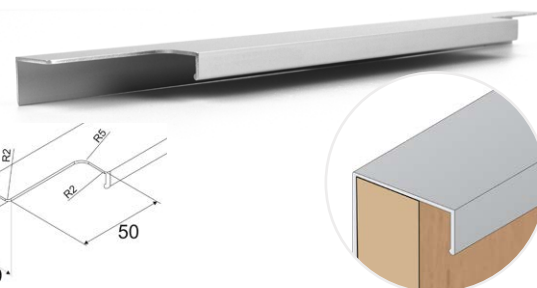
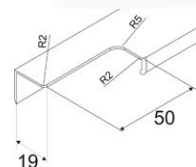
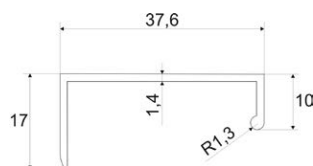
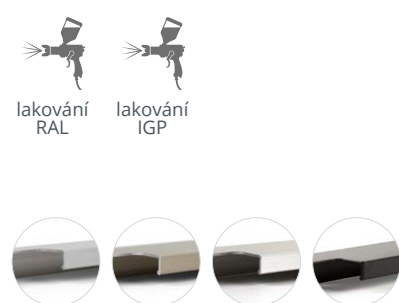

BARVA / DÉLKA (MM)	196	246	296	346	396	446	496	546	596	696	796	896	996	1 196
hliník	793900	793901	793902	793903	793904	793905	793906	793907	793908	793909	793910	793911	793912	793913
světlý nerez	793942	793943	793944	793945	793946	793947	793948	793949	793950	793951	793952	793953	793954	793955
tmavý nerez	793956	793957	793958	793959	793960	793961	793962	793963	793964	793965	793966	793967	793968	793969
chrom	793914	793915	793916	793917	793918	793919	793920	793921	793922	793923	793924	793925	793926	793927
černá	793928	793929	793930	793931	793932	793933	793934	793935	793936	793937	793938	793939	793940	793941



V případě, že potřebujete jiný rozměr profilové úchytky, obraťte se na naše obchodní oddělení. Vybrané druhy úchytek nabízíme také v provedení metráž, více informací na následující straně.

UK 9

- > materiál hliník
- > barva hliník, světlý nerez, tmavý nerez, šedý nerez, černá

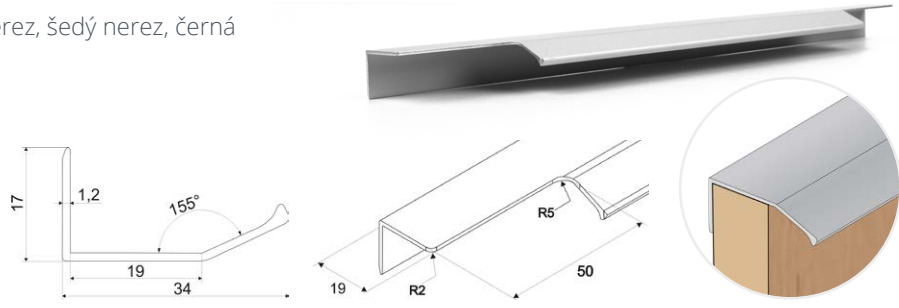

BARVA / DÉLKA (MM)	196	246	296	346	396	446	496	546	596	696	796	896	996	1 196
hliník	793970	793971	793972	793973	793974	793975	793976	793977	793978	793979	793980	793981	793982	793983
světlý nerez	793998	793999	794000	794001	794002	794003	794004	794005	794006	794007	794008	794009	794010	794011
tmavý nerez	794026	794027	794028	794029	794030	794031	794032	794033	794034	794035	794036	794037	794038	794039
šedý nerez	794012	794013	794014	794015	794016	794017	794018	794019	794020	794021	794022	794023	794024	794025
černá	793984	793985	793986	793987	793988	793989	793990	793991	793992	793993	793994	793995	793996	793997

PROFILOVÉ ÚCHYTKY - METRÁŽ

Úchytka lze rovněž zakoupit jako **úchytový profil v metráži v délce 3 m**. U této varianty není odfrézovaný stromeček k naražení do dvířek. Profil je však zapotřebí zkrátit na potřebnou délku, odfrézovat stromeček profilu k naražení do dvířek a začistit hranu profilu. Tato varianta je časově náročnější na přípravu a finální zpracování.

7

UK 2

- > délka 3 m
- > materiál hliník
- > barva hliník

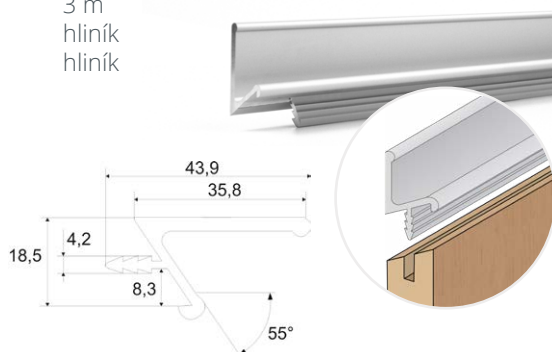

BARVA	KÓD
hliník	794096

UK 4

- > délka 3 m
- > materiál hliník
- > barva hliník

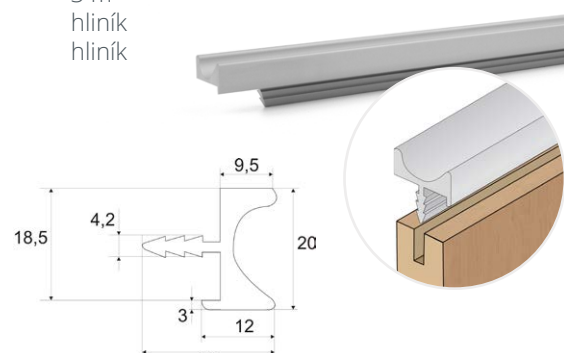

BARVA	KÓD
hliník	794097

UK 5

- > délka 3 m
- > materiál hliník, nerez
- > barva hliník, nerez

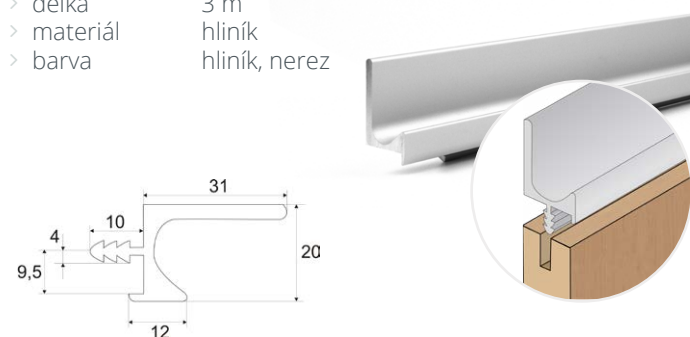

BARVA	KÓD
hliník	541585
nerez	794098

UK 6

- > délka 3 m
- > materiál hliník
- > barva hliník

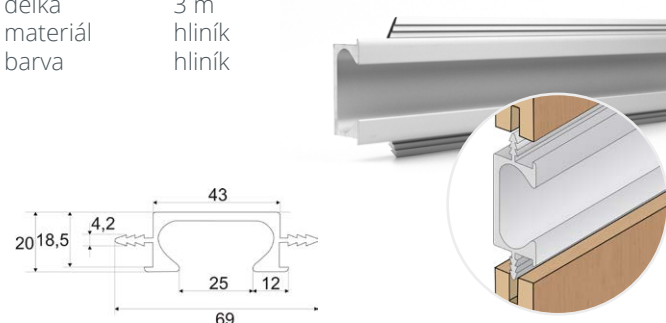

BARVA	KÓD
hliník	794099

7.9 PROFILOVÉ ÚCHYTKY - METRÁŽ

7 ÚCHYTKY, VĚŠÁKY A PROFILY



UK 7

- > délka 3 m
- > materiál hliník
- > barva hliník, světlý nerez, tmavý nerez

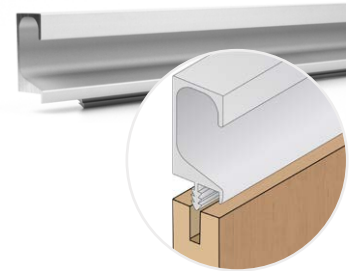
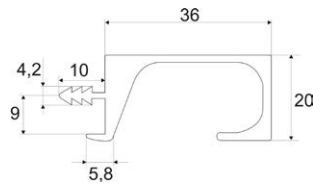

BARVA	KÓD
hliník	569249
nerez	683933

animadomus by Laguna®

LKW 5

- > délka 2,75 m
- > barva hliník

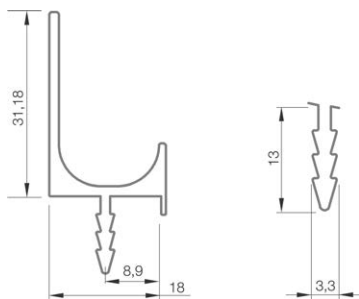

BARVA	KÓD
hliník	418653

LKW 7

- > délka 2,75 m
- > barva hliník

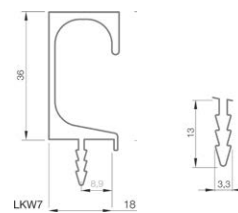

BARVA	KÓD
hliník	425389

PROFILY PRO BEZÚCHYTKOVÉ OTEVÍRÁNÍ

Profily pro bezúchytkové otevírání jsou velmi oblíbené pro **kuchyňská dvířka s čistou linií**.

Umístění profilu je vždy z vnitřní strany dvířek. Jsou upevňovány do lamina, 22 mm od horního okraje a 38,5 mm od bočního okraje. Otvor pro příchytku – plast 5 mm, kov 8 mm. Rozteč mezi otvory je 32 mm.

ÚPEVNĚNÍ PROFILŮ:

- > **Plastovou příchytkou (vodorovné)** - příchytka se naráží přímo do vyvrtaných otvorů. Profil je přichycen záříčkou ve tvaru „H“.
- > **Kovovou příchytkou (vodorovné)** - do vyvrtaných otvorů jsou vloženy plastové hmoždinky (M4), do kterých se příchytka montuje napevno pomocí šroubků. Profil je přichycen záříčkou se šroubkem.
- > **Vrtáním (svislý)** - profil je upevněn zápusťnými vruty do plechu (4,2 x 25) přes lamino, 20 mm od hrany.



MONTÁŽNÍ NÁVOD
profil J a C



FRÉZOVÁNÍ DO KORPUSU
profil J a C



Profil „C“ a „J“ vertikální

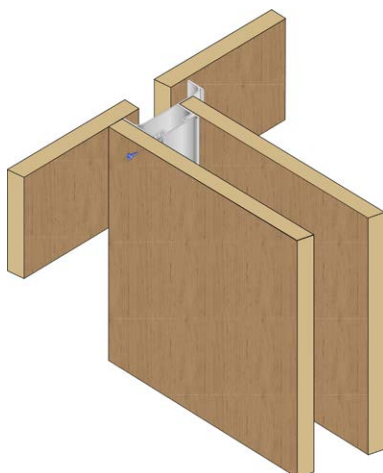

Profil „C“ a „J“ vertikální hranový

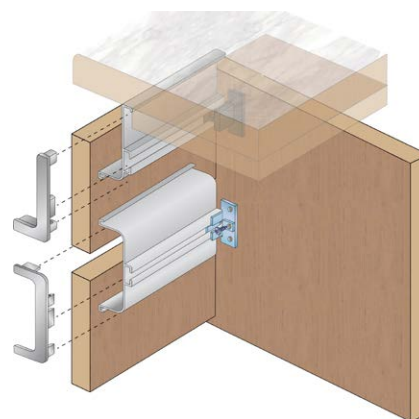
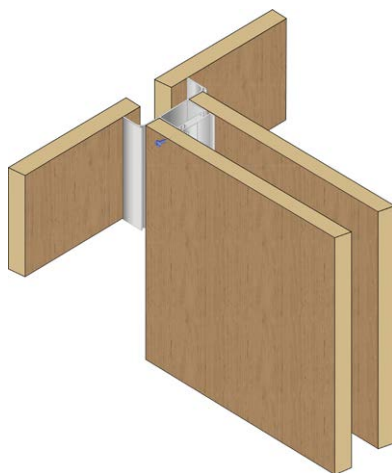

Úchytkový profil „C“

- > vodorovný profil pod pracovní desku
- > tvar profilu C
- > délka 3 m
- > materiál hliník
- > pov. úprava elox (hliník, nerez šedý), komaxit (černá)
- > barva hliník, nerez šedý nebo černá

Úchytkový profil „J“

- > vodorovný profil pod pracovní desku
- > tvar profilu J
- > délka 3 m
- > materiál hliník
- > pov. úprava elox (hliník, nerez šedý), komaxit (černá)
- > barva hliník, nerez šedý nebo černá

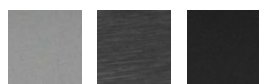

BARVA	KÓD
hliník	789395
nerez šedý	789396
černá	801195

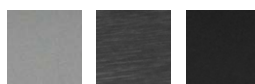

BARVA	KÓD
hliník	789403
nerez šedý	789404
černá	801199



Úchytový profil svislý hranový

- > svislý profil pro montáž na hranu (profil slouží rovněž jako ukončovací profil)
- > délka 3 m
- > materiál hliník
- > pov. úprava elox (hliník, nerez šedý), komaxit (černá)
- > barva hliník, nerez šedý nebo černá

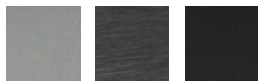

BARVA	KÓD
hliník	789408
nerez šedý	789410
černá	801203



Úchytový profil svislý

- > svislý profil
- > délka 3 m
- > materiál hliník
- > pov. úprava elox (hliník, nerez šedý), komaxit (černá)
- > barva hliník, nerez šedý nebo černá

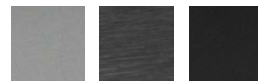

BARVA	KÓD
hliník	789411
nerez šedý	789412
černá	801204



DOPORUČENÉ PŘÍSLUŠENSTVÍ

Vnější roh

- > vnější roh pro úchytové profily „C“ nebo „J“
- > materiál hliník
- > pov. úprava elox (hliník), komaxit (černá)
- > barva hliník nebo černá



PRO PROFIL	BARVA	KÓD
„C“	elox	789400
	černá	801196
„J“	elox	789406
	černá	801200



Vnitřní roh

- > vnitřní roh pro úchytové profily „C“ nebo „J“
- > materiál hliník
- > pov. úprava elox (hliník), komaxit (černá)
- > barva hliník nebo černá

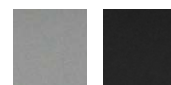

PRO PROFIL	BARVA	KÓD
„C“	elox	789401
	černá	801197
„J“	elox	789407
	černá	801201



Záslepka

- > záslepka pro úchytové profily „C“ nebo „J“
- > materiál hliník
- > pov. úprava elox (hliník), komaxit (černá)
- > barva hliník nebo černá

PRO PROFIL	BARVA	KÓD
„C“	elox	789402
	černá	801198
„J“	elox	789409
	černá	801202

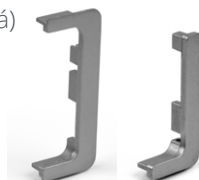

Kovový úchyt profilu

- > kovový příchyt (vodorovný) pro úchytové profily „C“ nebo „J“
- > materiál ocel

PRODUKT	KÓD
úchyt profilu	789398



Plastový úchyt profilu

- > plastový příchyt (vodorovný) pro úchytové profily „C“ nebo „J“
- > materiál plast

PRODUKT	KÓD
úchyt profilu	789399



Spojovací úhelník

- > spojovací úhelník pro úchytový profil „C“ a „J“
- > materiál ocel

PRODUKT	KÓD
spojovací úhelník	789397

