

07

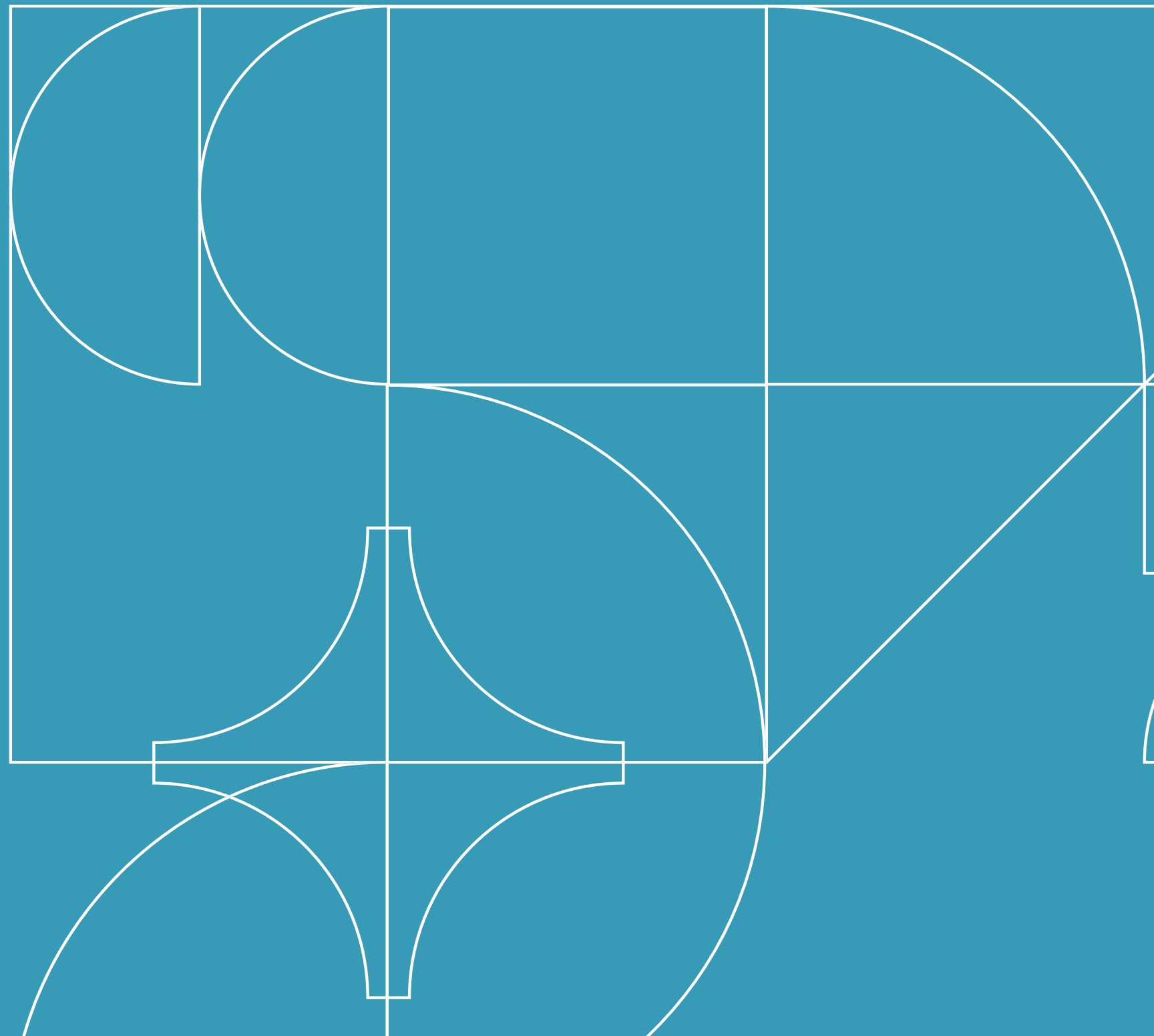

ÚCHYTKY

7

7.1	Kovové úchytky	361
7.2	Rustikální úchytky	385
7.3	Knopky	391
7.4	Dřevěné úchytky	398
7.5	Kožené a jiné úchytky	399
7.6	Plastové a dětské úchytky, knopky a věšáky	400
7.7	Zápustné úchytky	402
7.8	Věšáky	404
7.9	Profilové úchytky	411
7.10	Profily pro bezúchytkové otevírání	416

ÚCHYTKY

			
ADEL 361	ADINA 387	ADRIANA 402	AGLIA 386
			
ALBA 373	ALBERTA 387	ALESSANDRA 381	ALIDA 386
			
ALINA 388	AMELIA 390	ANABEL 377	ANDREW 365
			
ANGELA 379	ANZIO 369	ARDENIA II 390	ARIA 371
			
ARVIKA 398	ATHENA 403	BALDONE 369	BALMO 375
			
BÁRA 366	BASILIA II 377	BELLUNO 367	BERITA 366
			
BETA II 378	BOLTA 400	BRIGITA 381	CORDUBA 385
			
CORIA 378	CRISTINA 377	DALAS 399	DALIA 375
			
DARA 368	DARIA 363	DENY 364	DINIA 380

PŘEHLED ÚCHYTEK A VĚŠÁKŮ

7 ÚCHYTKY, VĚŠÁKY A PROFILY

			
DIVERA II 389	DORA 370	DORA II 370	DRIVA 398
			
EGARA 388	ELI 400	ELISA 371	EMILY 366
			
ENRICO 403	FECTIO 381	FERIA 365	GABRIELLA II 378
			
GENOA 379	GISSI 389	GRETA 390	HAIDA 387
			
HONEY 400	HRAZDA 10 374	HRAZDA 12 373	CHALCIS 370
			
IDA 370	INNA 403	INTRA 361	ISABEL 389
			
ISANA 384	IVANA 403	JOLANA 386	JOVANA 374
			
JULI 362	JULIE 379	KAIRA 383	KAROLÍNA 377
			
KORINA 364	KRIS 362	LAURA 377	LEILA 382

PŘEHLED ÚCHYTEK A VĚŠÁKŮ

7 ÚCHYTKY, VĚŠÁKY A PROFILY



LENNY 368



LESA 373



LIA 372



LILA 361



LIMA 371



LINE 380



LORA 374



LORENZA 364



LORI 379



MAJA 403



MARIA 378



MARILIN 390



MARINA 376



MEDILA 384



MIA 376



MILY 368



MISNIA 402



MONICA 376

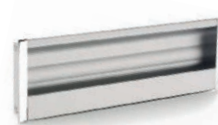

MONICA II 402



MUŠLE 398



NANCY 371



NATÁLIA 389



NEIVA 372



NICOLE 370



NIDUM 402



NIKOLETA 403



NINA 380



NOEMI 364



NORA 365



NURSIA 361



PABLOS 363



PARMA 375



PORTOS 363



RADOS 369



RAVENA 372



REBEKA 374

7

PŘEHLED ÚCHYTEK A VĚŠÁKŮ

7 ÚCHYTKY, VĚŠÁKY A PROFILY

			
REGINA 362	RIANA 389	RITA 387	ROSA 387
			
ROVIGO 383	RUBI 401	SALACIA 385	SALMA 371
			
SALOME 377	SALONA 380	SAMARA 366	SANDY II 363
			
SANTIAGO 399	SÁRA 376	SÁVA 384	SEBI 364
			
SERENA 379	SHEILA 365	SIENA 389	SIERA 381
			
SIMA 362	SPARTA II 385	STELA 388	TABITA 372
			
TEXAS 399	TORA 385	TORNEA 368	UGO 375
			
VALEDA 382	VANTANIA 381	VERONA 386	VERONICA 375
			
VESNA 388	VIANA 367	VIENA 386	VIKI 383

PŘEHLED ÚCHYTEK A VĚŠÁKŮ

7 ÚCHYTKY, VĚŠÁKY A PROFILY



VIKTORIE 402



VIOLETA 367



ZAIRA 385



ZITA 382



ZORA 375

KNOPKY



ADINA 395



AGLIA 394



ALMUS 397



ANGELA 391



BLOCK 392



CATARINA 393



CLEO GRANDE 396



CLEO PICCOLO 396



ELLIEN 396



ESSA 394



GAIA 395



INESA 393



ISSA 394



KELLI 397



KNOFLÍK 401



LAURA 394



LENNY 396



LIMA 393



LUPO 401



MARILIN 395



MESSANA 391



MONACUM 397



NAVARA 392



NOEMI 392

















PŘEHLED ÚCHYTEK A VĚŠÁKŮ

7 ÚCHYTKY, VĚŠÁKY A PROFILY

			
ONEX 396	QUADROS 392	SÁVA 392	SERENA 393
			
SIMON 395	SOLVA 395	SPARTA II 391	STELA 393
			
TORA 391	VALERIO 398	VESNA 394	VIANA 396
			
ZAIRA 391			

7

VĚŠÁKY

			
ALTIS 410	ANTONIO 409	AYA 405	CORA 405
			
DENVER 406	FABIO 406	FLINT 405	HVĚZDIČKA 401
			
ISIS 409	KANSAS 404	KUBO 407	KYTIČKA 401
			
MARCO 407	NAVY 410	NIA 410	PAOLO 409

PŘEHLED ÚCHYTEK A VĚŠÁKŮ

7 ÚCHYTKY, VĚŠÁKY A PROFILY

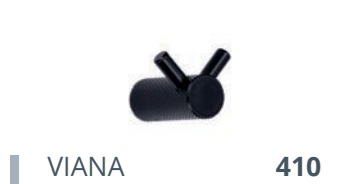
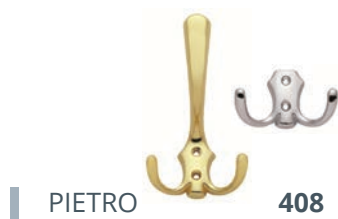
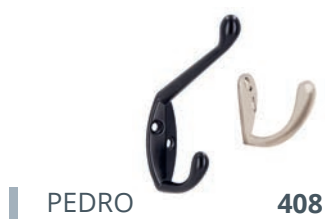

PROFILOVÉ ÚCHYTKY



7.1 KOVOVÉ ÚCHYTKY

7 ÚCHYTKY, VĚŠÁKY A PROFILY

7.1 KOVOVÉ ÚCHYTKY

LILA

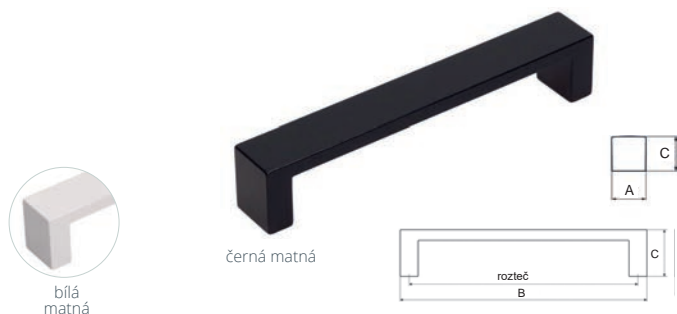

černá matná

bílá matná

BAREVNÉ PŘÍKRYTÍ	ROZTEČ	B	A	C	KÓD
bílá matná	160	170	20	26	757689
	192	202	20	26	757690
	320	330	20	26	759762
černá matná	128	138	20	26	820198
	160	170	20	26	757687
	192	202	20	26	757688
	320	330	20	26	759763

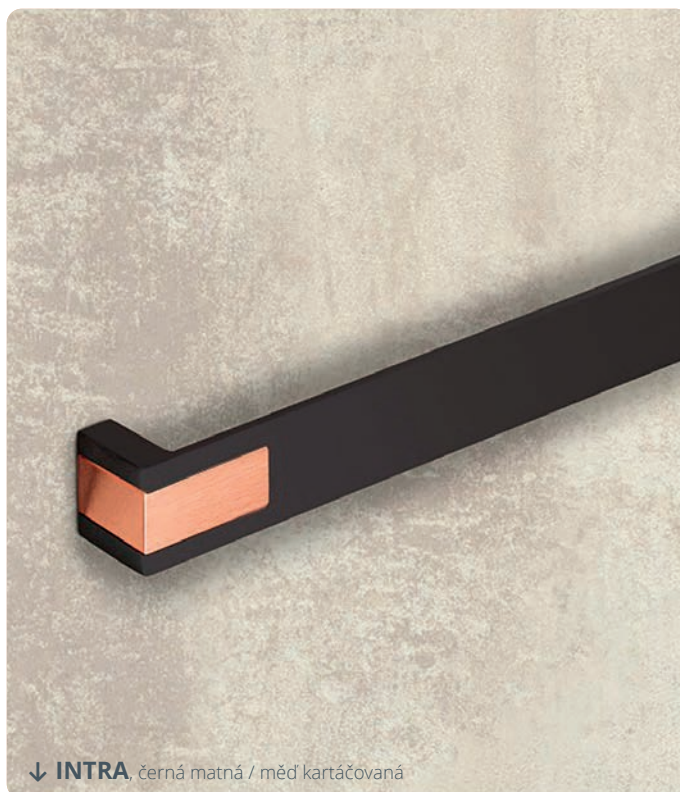

↓ INTRA, černá matná / měď kartáčovaná

INTRA

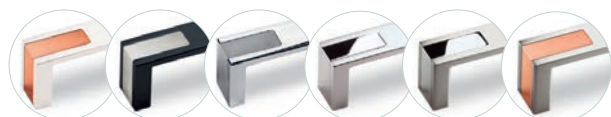

bílá matná / měď kartáčovaná
černá matná / nerez
chrom lesklý / chrom satén
chrom satén / chrom lesklý
imitace nerez / chrom lesklý
imitace nerez / měď kartáčovaná

BAREVNÉ PŘÍKRYTÍ	ROZTEČ	B	A	C	KÓD
bílá matná / měď kartáčovaná	192	204	25	26	665058
černá matná / měď kartáčovaná	192	204	25	26	806040
černá matná / nerez	192	204	25	26	665056
chrom lesklý / chrom satén	192	204	25	26	351235
chrom satén / chrom lesklý	192	204	25	26	317409
nerez / chrom lesklý	192	204	25	26	317410
nerez / měď kartáčovaná	192	204	25	26	665055



černá matná / měď kartáčovaná

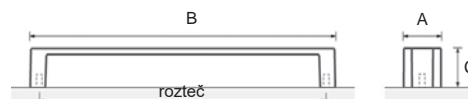

ADEL



černá matná



nikl matný

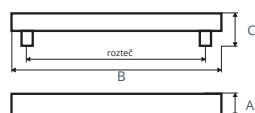

BAREVNÉ PŘÍKRYTÍ	ROZTEČ	B	A	C	KÓD
černá matná	160	168	19	27	756510
nikl matný	160	168	19	27	657410

NURSIA



černá matná



chrom matný
nerez kartáčovaný

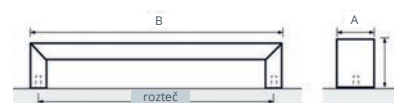

BAREVNÉ PŘÍKRYTÍ	ROZTEČ	B	A	C	KÓD
černá matná	160	168	25	30	808922
chrom matný	160	168	25	30	369570
nerez kartáčovaný	160	168	25	30	369565

7.1 KOVOVÉ ÚCHYTKY

7 ÚCHYTKY, VĚŠÁKY A PROFILY

JULI



antracit



chrom lesklý měď černá nikl jemně broušený nikl matný

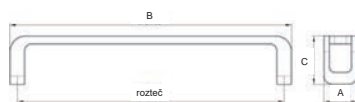

BAREVNÉ PŘÍKRYTÍ	ROZTEČ	B	A	C	KÓD
antracit	160	169	20	29	802108
chrom lesklý	160	169	20	29	825688
měď černá	160	169	20	29	802112
nikl jemně broušený	160	169	20	29	802110
nikl matný	160	169	20	29	802111



← JULI, měď černá

REGINA

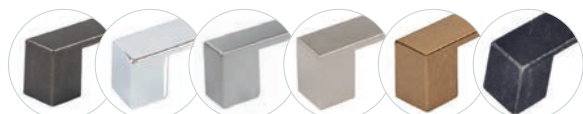

antik ocel efekt chrom lesklý chrom matný nikl jemně broušený starozlatá železo černé patina



železo broušené

BAREVNÉ PŘÍKRYTÍ	ROZTEČ	B	A	C	KÓD
antik ocel efekt	128	161	20	27	703748
chrom lesklý	128	161	20	27	677978
chrom matný	128	161	20	27	697246
nikl jemně broušený	128	161	20	27	710503
starozlatá	128	161	20	27	794178
železo broušené	128	161	20	27	700740
železo černé patina	128	161	20	27	786253

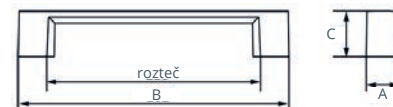

SIMA



železo černá patina



černá matná nikl jemně broušený

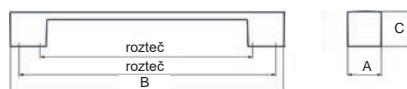

BAREVNÉ PŘÍKRYTÍ	ROZTEČ	B	A	C	KÓD
černá matná	160/192	205	25	25	011664
nikl jemně broušený	160/192	205	25	25	750088
železo černá patina	160/192	205	25	25	723805

KRIS

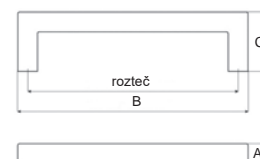

BAREVNÉ PŘÍKRYTÍ	ROZTEČ	B	A	C	KÓD
nerez	160	180	12	22	512698
	320	340	12	22	512699

7.1 KOVOVÉ ÚCHYTKY

7 ÚCHYTKY, VĚŠÁKY A PROFILY

PORTOS



černá matná

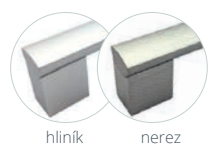

hliník nerez



BAREVNÉ PROVEDENÍ	ROZTEČ	KÓD			
černá matná	96 105 17 30	825772			
	128 137 17 30	825773			
	160 169 17 30	825774			
	192 201 17 30	825775			
	224 233 17 30	825776			
	320 329 17 30	825777			
	448 457 17 30	825778			
	544 553 17 30	825779			
hliník	640 649 17 30	825780			
	736 745 17 30	825781			
	96 105 17 30	553014			
	128 137 17 30	344298			
	160 169 17 30	344300			
	192 201 17 30	344302			
	224 233 17 30	344304			
	320 329 17 30	344306			
nerez	448 457 17 30	344308			
	544 553 17 30	344310			
	640 649 17 30	344312			
	736 745 17 30	344314			
	96 105 17 30	553015			
	128 137 17 30	344299			
	160 169 17 30	344301			
	192 201 17 30	344303			
imitace nerez	224 233 17 30	344305			
	320 329 17 30	344307			
	448 457 17 30	344309			
	544 553 17 30	344311			
	640 649 17 30	344313			
	736 745 17 30	344315			

PABLOS



imitace nerez

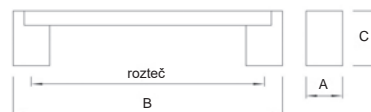

hliník / chrom lesklý hliník / chrom satén imitace nerez / chrom

BAREVNÉ PROVEDENÍ	ROZTEČ	B	A	C	KÓD
hliník/chrom lesklý	160	180	20	30	344235
	224	244	20	30	344237
	320	340	20	30	344239
	416	436	20	30	344241
	512	532	20	30	344243
	640	660	20	30	344245
	736	756	20	30	344247
	hliník/chrom satén	160	180	20	30
224		244	20	30	375794
320		340	20	30	375795
416		436	20	30	375796
512		532	20	30	375797
640		660	20	30	375798
736		756	20	30	375799
imitace nerez		160	180	20	30
	224	244	20	30	391024
	320	340	20	30	391025
	416	436	20	30	394637
	512	532	20	30	395739
	640	660	20	30	395740
	736	756	20	30	395741
	imitace nerez/chrom	160	180	20	30
224		244	20	30	344238
320		340	20	30	344240
416		436	20	30	344242
512		532	20	30	344244
640		660	20	30	344246
736		756	20	30	344248

SANDY II



BAREVNÉ PROVEDENÍ	ROZTEČ	B	A	C	KÓD
chrom lesklý/nerez	160	179	16	25	825646
	224/256	275	16	25	825647
	352/384	403	16	25	825648

DARIA

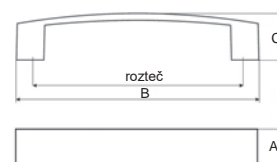

BAREVNÉ PROVEDENÍ	ROZTEČ	B	A	C	KÓD
hliník	128	146	25	28	063677

7.1 KOVOVÉ ÚCHYTKY 7 ÚCHYTKY, VĚŠÁKY A PROFILY

NOEMI



černá

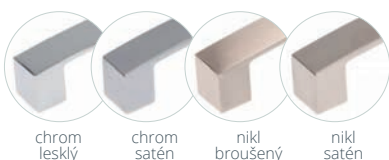
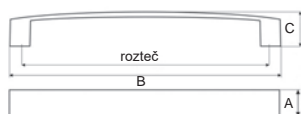

NOEMI

BAREVNÉ PŘÍKRYTÍ	ROZTEČ	B	A	C	KÓD
černá	128	146	20	28	762445
	160	178	20	28	763002
	192	210	20	28	763003
	256	274	20	28	763004
	320	338	20	28	763005
chrom lesklý	128	146	20	28	851536
	160	178	20	28	310091
	192	210	20	28	683331
	256	274	20	28	310097
	320	338	20	28	310098
chrom satén	128	146	20	28	293899
	160	178	20	28	219554
	192	210	20	28	224267
	256	274	20	28	224270
	320	338	20	28	224271
nikel broušený	128	146	20	28	671630
	160	178	20	28	689542
	192	210	20	28	689543
	256	274	20	28	667614
	320	338	20	28	689546
nikel satén	128	146	20	28	689549
	160	178	20	28	712543
	192	210	20	28	310100
	256	274	20	28	219552
	320	338	20	28	223176
	256	274	20	28	224266
	320	338	20	28	223732

DENY



neroz broušený



neroz / antracit

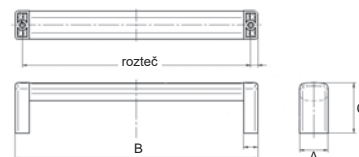

BAREVNÉ PŘÍKRYTÍ	ROZTEČ	B	A	C	KÓD
neroz broušený	160	170	20	35	581307
	320	330	20	35	581308
neroz/antracit	160	170	20	35	581309
	320	330	20	35	581310

KORINA



černá matná



chrom lesk

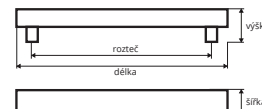

BAREVNÉ PŘÍKRYTÍ	ROZTEČ	B	A	C	KÓD
černá matná	32	55	23	25	825653
	128	167	23	28	825654
	224	263	23	28	825655
	320	359	23	28	825656
nikel broušený	32	55	23	25	825649
	128	167	23	28	825650
	224	263	23	28	825651
	320	359	23	28	825652

SEBI



černá / chrom



bílá / chrom

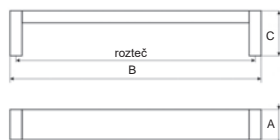

BAREVNÉ PŘÍKRYTÍ	ROZTEČ	B	A	C	KÓD
bílá/chrom	96	104	20	30	511009
	128	136	20	30	511010
	256	264	20	30	511011
černá/chrom	96	104	20	30	511012
	128	136	20	30	511013
	256	264	20	30	511014

LORENZA



chrom satén



nikel broušený nikel satén

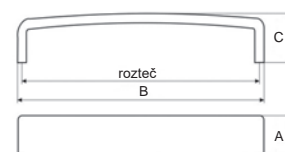

BAREVNÉ PŘÍKRYTÍ	ROZTEČ	B	A	C	KÓD
chrom satén	128	134	20	28	410190
nikel broušený	128	134	20	28	662656
nikel satén	128	134	20	28	514624

7.1 KOVOVÉ ÚCHYTKY

7 ÚCHYTKY, VĚŠÁKY A PROFILY

NORA

BAREVNÉ PŘÍKRYTÍ	ROZTEČ	B	A	C	KÓD
černá matná	128	135	25	30	825744
	160	167	25	30	825745
	192	199	25	30	825746
	320	327	25	30	825747
hliník	128	135	25	30	825728
	160	167	25	30	825729
	192	199	25	30	825730
	320	327	25	30	825731
chrom lesklý	128	135	25	30	825740
	160	167	25	30	825741
	192	199	25	30	825742
	320	327	25	30	825743
nikl broušený-matný	128	135	25	30	825736
	160	167	25	30	825737
	192	199	25	30	825738
	320	327	25	30	825739
nikl satén	128	135	25	30	825732
	160	167	25	30	825733
	192	199	25	30	825734
	320	327	25	30	825735

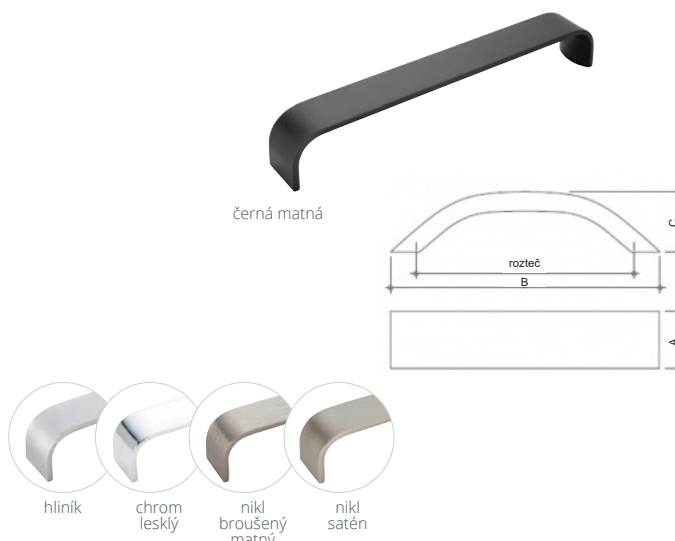

SHEILA

BAREVNÉ PŘÍKRYTÍ	ROZTEČ	B	A	C	KÓD
černá matná	128	144	24	34	825764
	160	178	24	34	825765
	192	209	24	34	825766
	320	352	24	34	825767
hliník	128	144	24	34	825748
	160	178	24	34	825749
	192	209	24	34	825750
	320	352	24	34	825751
chrom lesklý	128	144	24	34	825760
	160	178	24	34	825761
	192	209	24	34	825762
	320	352	24	34	825763
nikl broušený	128	144	24	34	825768
	160	178	24	34	825769
	192	209	24	34	825770
	320	352	24	34	825771
nikl broušený-matný	128	144	24	34	825756
	160	178	24	34	825757
	192	209	24	34	825758
	320	352	24	34	825759
nikl satén	128	144	24	34	825752
	160	178	24	34	825753
	192	209	24	34	825754
	320	352	24	34	825755

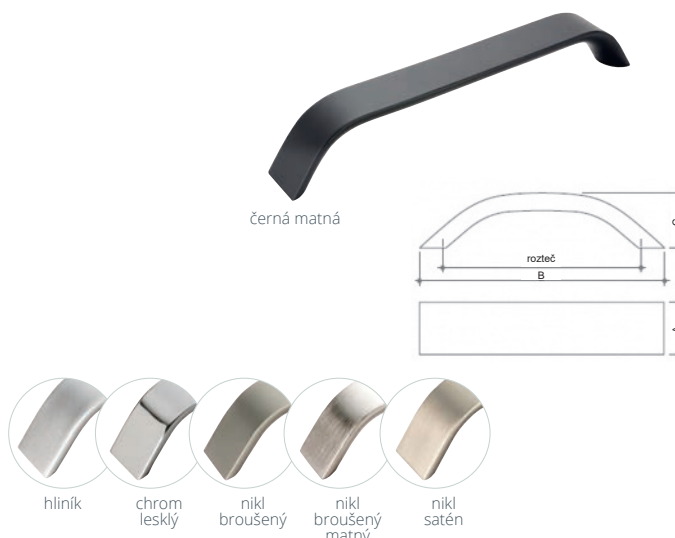

ANDREW

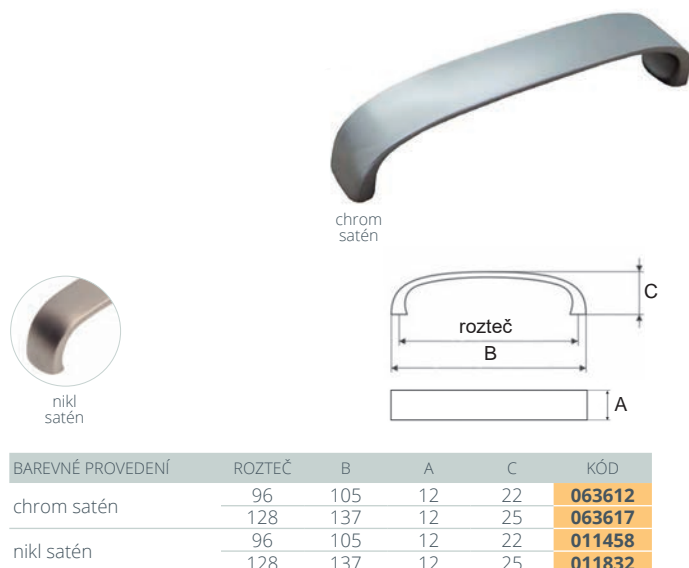

BAREVNÉ PŘÍKRYTÍ	ROZTEČ	B	A	C	KÓD
chrom satén	96	105	12	22	063612
	128	137	12	25	063617
nikl satén	96	105	12	22	011458
	128	137	12	25	011832

FERIA

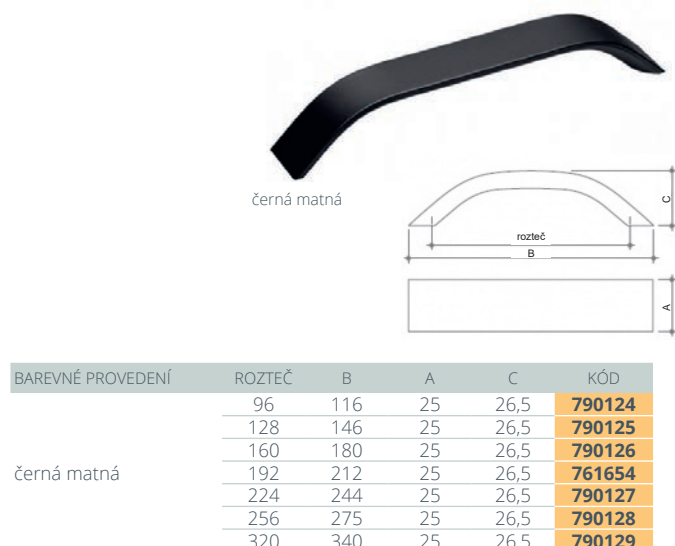

BAREVNÉ PŘÍKRYTÍ	ROZTEČ	B	A	C	KÓD
černá matná	96	116	25	26,5	790124
	128	146	25	26,5	790125
	160	180	25	26,5	790126
	192	212	25	26,5	761654
	224	244	25	26,5	790127
	256	275	25	26,5	790128
	320	340	25	26,5	790129

7.1 KOVOVÉ ÚCHYTKY

7 ÚCHYTKY, VĚŠÁKY A PROFILY

EMILY

BAREVNÉ PŘÍKRYTÍ	ROZTEČ	B	A	C	KÓD
bílá	128	137	19	24	861410
	160	169	19	24	861415
	192	301	19	24	861420
	320	329	19	24	861425
černá	128	137	19	24	861409
	160	169	19	24	861414
	192	301	19	24	861419
	320	329	19	24	861424
chrom lesklý	128	137	19	24	861406
	160	169	19	24	861411
	192	301	19	24	861416
	320	329	19	24	861421
chrom satén	128	137	19	24	861408
	160	169	19	24	861413
	192	301	19	24	861418
	320	329	19	24	861423
nikl broušený	128	137	19	24	861407
	160	169	19	24	861412
	192	301	19	24	861417
	320	329	19	24	861422



černá

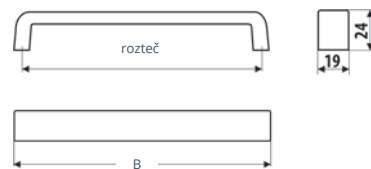

bílá chrom lesklý chrom satén nikl broušený

BÁRA



nerez broušený/
chrom lesklý

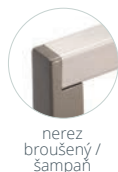

nerez broušený / šampaň



BAREVNÉ PŘÍKRYTÍ	ROZTEČ	B	A	C	KÓD
nerez broušený/ chrom lesklý	128	138	14,5	35	581240
	160	170	14,5	35	581241
	256	266	14,5	35	581242
	320	330	14,5	35	581243
nerez broušený/ šampaň	128	138	14,5	35	581235
	160	170	14,5	35	581236
	256	266	14,5	35	581237
	320	330	14,5	35	581238

BERITA



chrom lesklý /
bílá



chrom lesklý / černá nikl jemně broušený / bílá nikl jemně broušený / černá

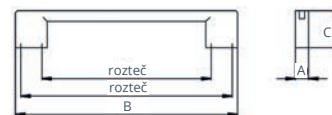

BAREVNÉ PŘÍKRYTÍ	ROZTEČ	B	A	C	KÓD
chrom lesklý / bílá	128/160	168	10	28	687520
chrom lesklý / černá	128/160	168	10	28	644302
nikl jemně broušený / bílá	128/160	168	10	28	689517
nikl jemně broušený / černá	128/160	168	10	28	689520

SAMARA

BAREVNÉ PŘÍKRYTÍ	ROZTEČ	B	A	C	KÓD
hliník černý broušený	128/224	252	10	29	873462
	224/320	348	10	29	873463
	384/480	508	10	29	873464
	640/736	764	10	29	873465
chrom lesklý	128/224	252	10	29	298327
	160/256	284	10	29	638089
	192/288	316	10	29	357322
	224/320	348	10	29	342733
	288/384	412	10	29	541867
	320/416	444	10	29	370609
	352/448	476	10	29	708259
	384/480	508	10	29	749854
	480/576	604	10	29	381360
	640/736	764	10	29	342732
nikl jemně broušený	128/224	252	10	29	298328
	160/256	284	10	29	353452
	192/288	316	10	29	353449
	224/320	348	10	29	314724
	288/384	412	10	29	366844
	320/416	444	10	29	295976
	352/448	476	10	29	353446
384/480	508	10	29	362868	
480/576	604	10	29	364772	
640/736	764	10	29	314723	



hliník černý broušený

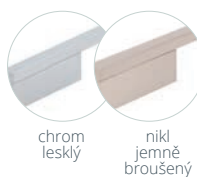
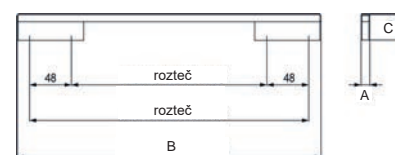

chrom lesklý nikl jemně broušený

7.1 KOVOVÉ ÚCHYTKY

7 ÚCHYTKY, VĚŠÁKY A PROFILY

VIOLETA

BAREVNÉ PROVEDENÍ	ROZTEČ	B	A	C	KÓD
antik ocel efekt	128	140	9	30	638254
	160	172	9	30	683197
	192	204	9	30	672161
bílá lesk	128	140	9	30	766454
	192	204	9	30	786704
	128	140	9	30	754951
černá matná	160	172	9	30	794407
	192	204	9	30	710900
černá měď	160	172	9	30	860440
	96	108	9	30	780009
chrom lesklý	128	140	9	30	356626
	160	172	9	30	355827
	192	204	9	30	292275
nikl jemně broušený	320	332	9	30	736378
	96	108	9	30	739290
	128	140	9	30	351943
	160	172	9	30	366265
	192	204	9	30	387865
	320	332	9	30	741079
železo broušené	160	172	9	30	678926
	192	204	9	30	688213

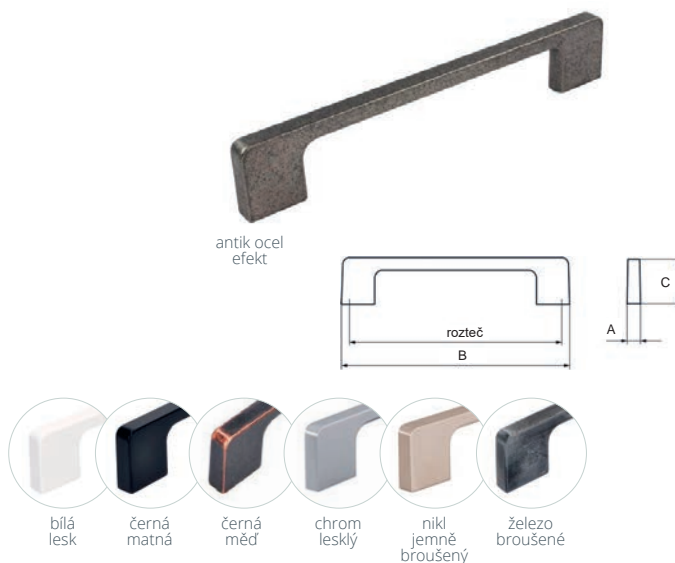

BELLUNO



BAREVNÉ PROVEDENÍ	ROZTEČ	B	A	C	KÓD
černá matná	96	130	9	28	808815
	160/192	200	9	30	808813
	224/256	267	9	30	808814
chrom lesklý	96	130	9	28	036856
	160/192	200	9	30	071236
	224/256	267	9	30	071477
chrom matný	96	130	9	28	696405
	160/192	200	9	30	696408
	224/256	267	9	30	040317
nerez finiš	96	130	9	28	351061
	160/192	200	9	30	351142
	224/256	267	9	30	351194

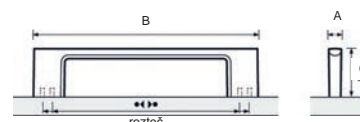

VIANA



BAREVNÉ PROVEDENÍ	ROZTEČ	B	A	C	KÓD
černá matná	96	110	12	32	787903
	128	142	12	32	787898
	160	174	12	32	343214
	192	206	12	32	124603
	320	334	12	32	786991
	480	494	12	32	853028
ušlechtilá ocel mat	2x 368	750	12	32	855959
	96	110	12	32	787904
	128	142	12	32	787899
	160	174	12	32	787900
	192	206	12	32	787901
	320	334	12	32	787902
starozlatá	2x 368	750	12	32	864310
	160	174	12	32	873443
	320	334	12	32	020008

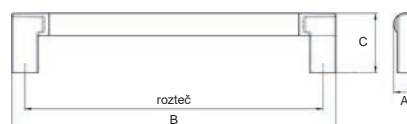

7.1 KOVOVÉ ÚCHYTKY

7 ÚCHYTKY, VĚŠÁKY A PROFILY

DARA

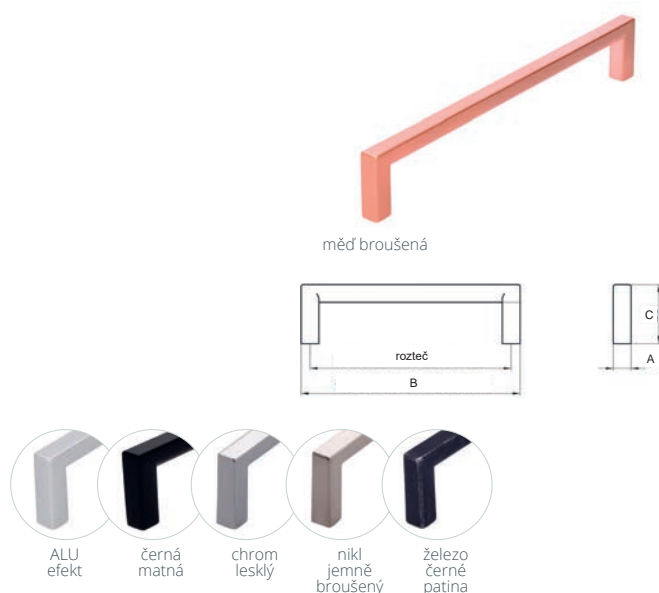

BAREVNÉ PROVEDENÍ	ROZTEČ	B	A	C	KÓD
ALU efekt	96	104	9	28	540853
	128	136	9	28	532591
	160	168	9	28	528447
	192	200	9	28	546442
	224	232	9	28	676459
	320	328	9	28	626087
černá matná	96	104	9	28	768239
	128	136	9	28	787866
	160	168	9	28	768241
	192	200	9	28	755694
	224	232	9	28	208491
	320	328	9	28	787868
chrom lesklý	96	104	9	28	522345
	128	136	9	28	571472
	160	168	9	28	528473
	192	200	9	28	522340
	224	232	9	28	522341
	320	328	9	28	524730
měď broušená	160	168	9	28	802098
	224	232	9	28	802099
nikl jemně broušený	96	104	9	28	533192
	128	136	9	28	628489
	160	168	9	28	571660
	192	200	9	28	522342
	224	232	9	28	571659
	320	328	9	28	516002
železo černé patina	128	136	9	28	787867
	160	168	9	28	738607
320	328	9	28	787869	

MILY

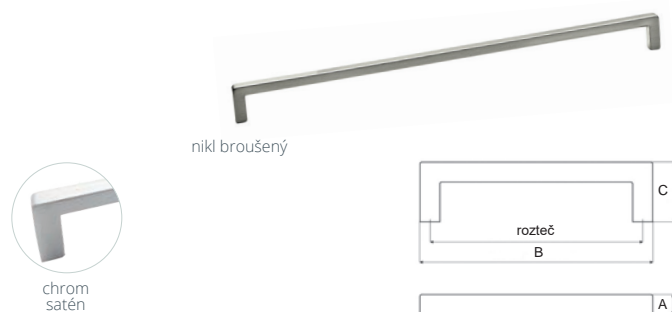

BAREVNÉ PROVEDENÍ	ROZTEČ	B	A	C	KÓD
chrom satén	192	200	8	27	376092
	320	328	8	27	376093
	448	459	8	27	376094
nikl broušený	96	104	8	27	376095
	128	136	8	27	376096
	160	168	8	27	376097
	192	200	8	27	376098
	320	328	8	27	376099
	448	459	8	27	376100



TORNEA

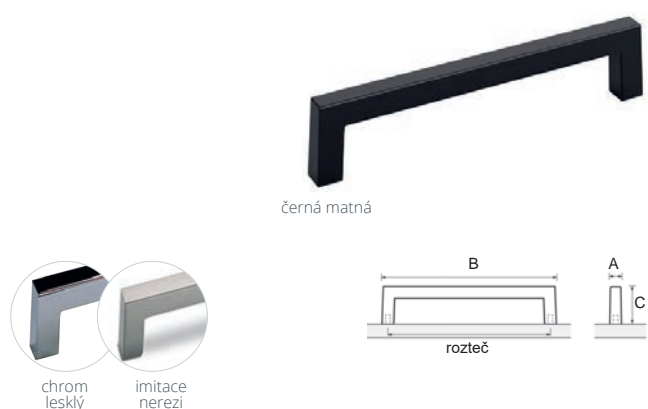

BAREVNÉ PROVEDENÍ	ROZTEČ	B	A	C	KÓD
černá matná	128	138	10	32	808946
	192	202	10	32	808947
chrom lesklý	128	138	10	32	351074
	192	202	10	32	351159
imitace nerezí	128	138	10	32	351134
	192	202	10	32	351198

LENNY

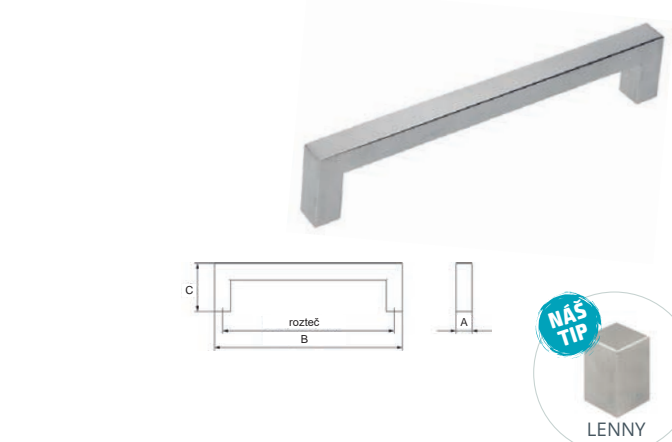

BAREVNÉ PROVEDENÍ	ROZTEČ	B	A	C	KÓD
nerez	96	108	12	35	695707
	128	140	12	35	702222
	160	172	12	35	696857
	320	332	12	35	680663

7.1 KOVOVÉ ÚCHYTKY

7 ÚCHYTKY, VĚŠÁKY A PROFILY

ANZIO

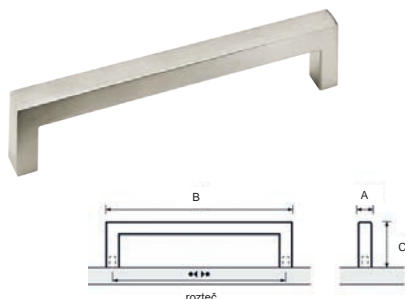

BAREVNÉ PŘÍKRYTÍ	ROZTEČ	B	A	C	KÓD
nerez kartáčovaný	96	106	10	32	664643
	128	138	10	32	351141
	160	170	10	32	351185
	192	202	10	32	664644
	224	234	10	32	351227
	288	298	10	32	351274
	320	330	10	32	664646
	352	362	10	32	351304
	480	490	10	32	351363
	608	618	10	32	351557
	736	746	10	32	351607



BALDONE

BAREVNÉ PŘÍKRYTÍ	ROZTEČ	B	A	C	KÓD
černá matná	96	104	11	26	808812
	128	136	11	26	808809
	160	168	11	26	808810
	256	264	15	29	808811
chrom lesklý	96	104	11	26	350963
	128	168	11	26	738015
	160	136	11	26	351031
chrom matný	256	264	15	29	351234
	96	104	11	26	350962
	160	136	11	26	351032
nerez finiš	256	168	11	26	351233
	128	264	15	29	350986
	96	104	11	26	350995
	128	136	11	26	351016
	160	168	11	26	351056
	256	264	15	29	351269

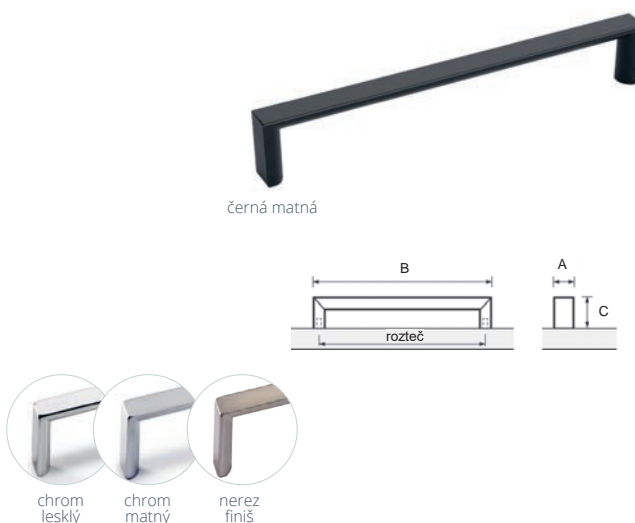

RADOS

BAREVNÉ PŘÍKRYTÍ	ROZTEČ	B	A	C	KÓD
hliník	128	140	8	34	344263
	160	172	8	34	344266
	224	236	8	34	344269
	320	332	8	34	344272
	416 (3závitová)	428	8	34	344275
chrom lesklý	128	140	8	34	344264
	160	172	8	34	344267
	224	236	8	34	344270
	320	332	8	34	344273
	416 (3závitová)	428	8	34	344276
imitace nerez	128	140	8	34	344265
	160	172	8	34	344268
	224	236	8	34	344271
	320	332	8	34	344274
	416 (3závitová)	428	8	34	344277



7.1 KOVOVÉ ÚCHYTKY 7 ÚCHYTKY, VĚŠÁKY A PROFILY

CHALCIS

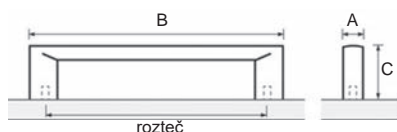

BAREVNÉ PROVEDENÍ	ROZTEČ	B	A	C	KÓD
imitace nerezí	128	147	11	31	351039
	288	301	11	31	351238

NICOLE

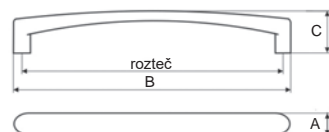

BAREVNÉ PROVEDENÍ	ROZTEČ	B	A	C	KÓD
nikl satén	128	138	13	25	011457

IDA



chrom satén



chrom lesklý

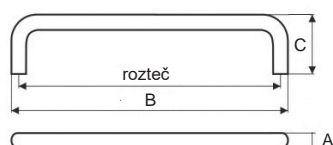

BAREVNÉ PROVEDENÍ	ROZTEČ	B	A	C	KÓD
chrom lesklý	96	104	8	30	349277
chrom satén	96	104	8	30	349278

DORA

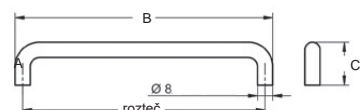

BAREVNÉ PROVEDENÍ	ROZTEČ	B	A	C	KÓD
chrom lesklý	128	136	8	30	581179
	256	264	8	30	581181
	320	264	8	28	581182

DORA II

BAREVNÉ PROVEDENÍ	ROZTEČ	B	A	C	KÓD
černá matná	64	74	10	29	823040
	96	106	10	29	823020
	128	138	10	29	823026
chrom lesklý	64	74	10	29	823041
	96	106	10	29	823021
	128	138	10	29	823027
chrom satén	160	170	10	29	823032
	64	74	10	29	823042
	96	106	10	29	823022
mosaz lesk	128	138	10	29	823028
	160	170	10	29	823036
	192	202	10	29	823033
nerezová ocel černá	96	106	10	29	823025
	128	138	10	29	823031
	160	170	10	29	823035
nikl jemně broušený	192	202	10	29	823039
	96	106	10	29	859440
	128	138	10	29	859439
nikl mat	64	74	10	29	823043
	96	106	10	29	823023
	128	138	10	29	823029
nikl mat	160	170	10	29	823033
	64	74	10	29	823044
	96	106	10	29	823024
nikl mat	128	138	10	29	823030
	160	170	10	29	823034
	192	202	10	29	823038



černá matná

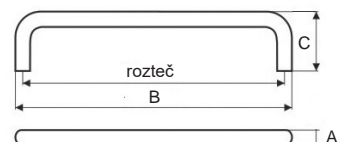

7.1 KOVOVÉ ÚCHYTKY

7 ÚCHYTKY, VĚŠÁKY A PROFILY

ARIA



BAREVNÉ PŘÍMĚŠENÍ	ROZTEČ	B	A	C	KÓD
železo broušené	160	170	10	31	047379
	320	330	10	31	873830

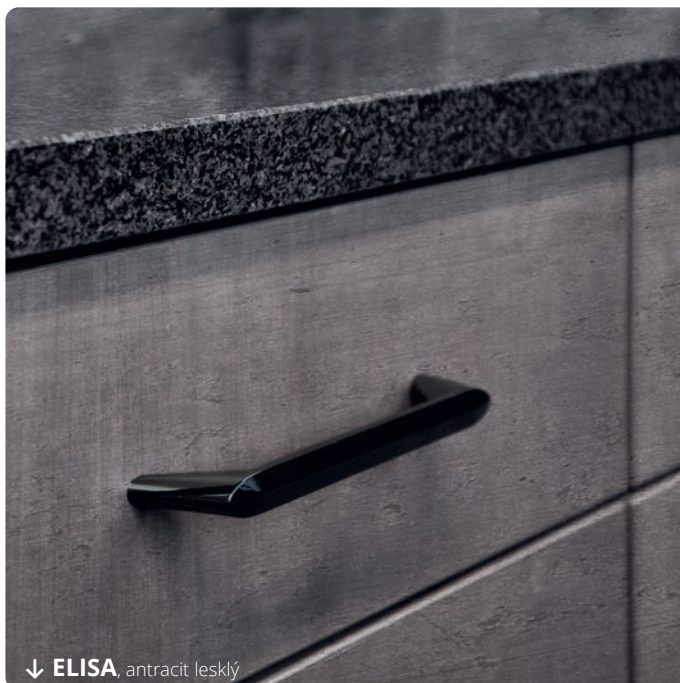

LIMA

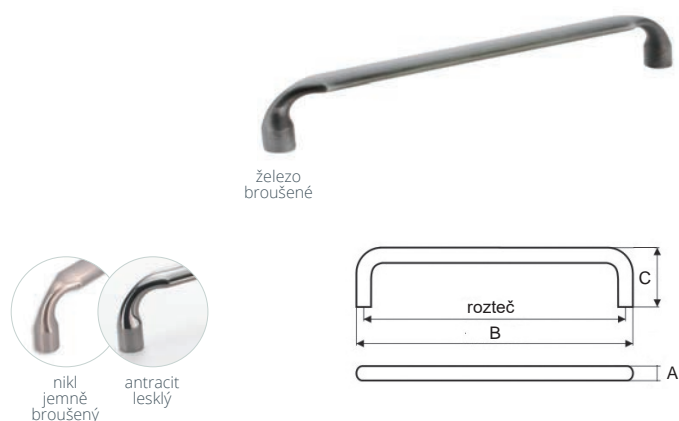

BAREVNÉ PŘÍMĚŠENÍ	ROZTEČ	B	A	C	KÓD
antracit lesklý	160	171	15	31	787884
nikl jemně broušený	160	171	15	31	787885
železo broušené	160	171	15	31	787886

ELISA

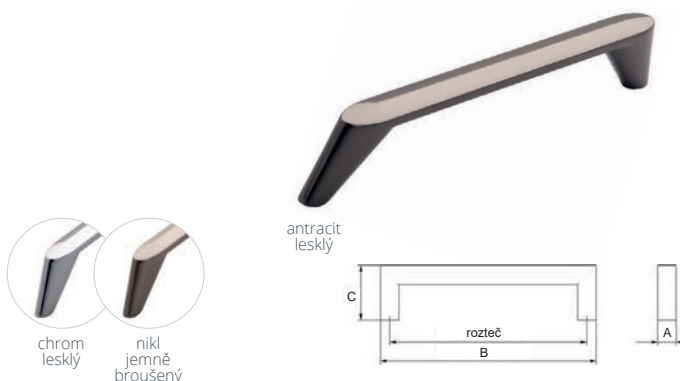

BAREVNÉ PŘÍMĚŠENÍ	ROZTEČ	B	A	C	KÓD
antracit lesklý	160	174	13	31	859441
	320	335	13	31	859444
chrom lesklý	160	174	13	31	859442
	320	335	13	31	859445
nikl jemně broušený	160	174	13	31	859443
	320	335	13	31	859446

NANCY

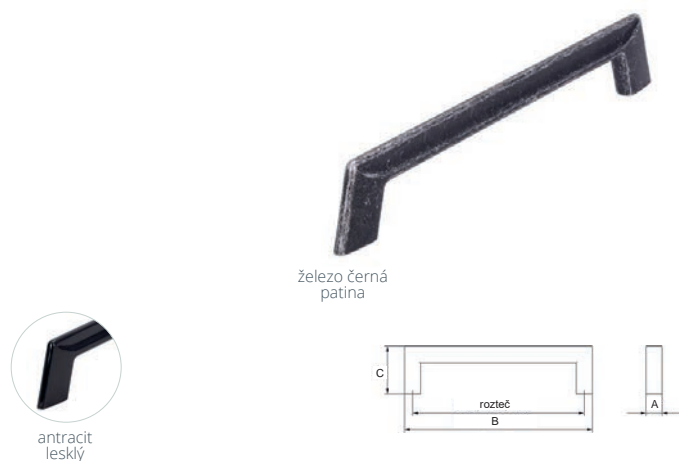

BAREVNÉ PŘÍMĚŠENÍ	ROZTEČ	B	A	C	KÓD
antracit lesklý	160	190	8	34	881377
	320	350	8	34	881378
železo černá patina	160	190	8	34	491354
	320	350	8	34	829545

SALMA

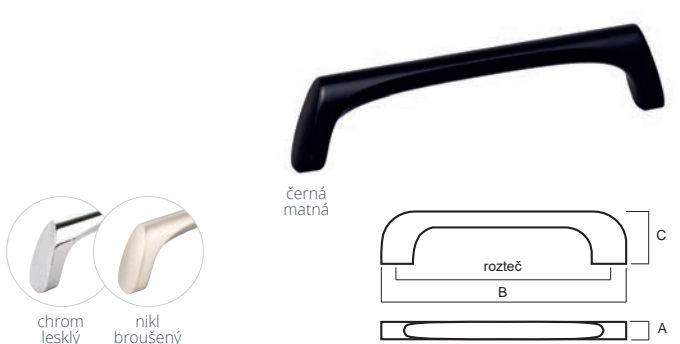

BAREVNÉ PŘÍMĚŠENÍ	ROZTEČ	B	A	C	KÓD
černá matná	128	137	16	31	825657
	224	233	16	31	825658
	320	329	16	31	825659
chrom lesklý	128	137	16	31	825660
	224	233	16	31	825661
	320	329	16	31	825662
nikl broušený	128	137	16	31	825663
	224	233	16	31	825664
	320	329	16	31	825665

7.1 KOVOVÉ ÚCHYTKY 7 ÚCHYTKY, VĚŠÁKY A PROFILY

RAVENA



černá matná



nerez

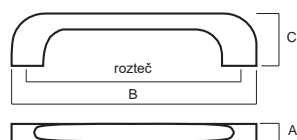

BAREVNÉ PROVEDENÍ	ROZTEČ	B	A	C	KÓD
černá matná	160	184	12	28	774524
nerez	160	184	12	28	774525

TABITA



černá matná



chrom lesklý
nikl broušený

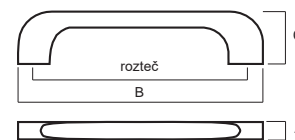

BAREVNÉ PROVEDENÍ	ROZTEČ	B	A	C	KÓD
černá matná	128	158	13	25	825678
	224	255	13	25	825679
	320	351	13	25	825680
chrom lesklý	128	158	13	25	825681
	224	255	13	25	825682
	320	351	13	25	825683
nikl broušený	128	158	13	25	825684
	224	255	13	25	825685
	320	351	13	25	825686

NEIVA



antracit lesklý
chrom lesklý
nikl jemně broušený



antracit matný

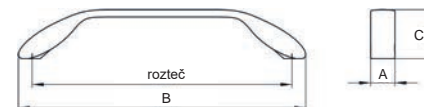

BAREVNÉ PROVEDENÍ	ROZTEČ	B	A	C	KÓD
antracit lesklý	160	177	15	30	655806
	320	337	15	30	754619
antracit matný	160	177	15	30	642404
	320	337	15	30	660995
chrom lesklý	128	145	15	30	519007
	160	177	15	30	748779
	192	209	15	30	530413
nikl jemně broušený	320	337	15	30	519006
	128	145	15	30	542710
	160	177	15	30	539594
	192	209	15	30	527316
	320	337	15	30	532153

LIA



antracit



chrom lesklý
nikl jemně broušený



BAREVNÉ PROVEDENÍ	ROZTEČ	B	A	C	KÓD
antracit	160	192	12	33	802123
	320	352	12	33	802126
chrom lesklý	160	192	12	33	802122
	320	352	12	33	802125
nikl jemně broušený	160	192	12	33	802124
	320	352	12	33	802127



← LIA, antracit

7.1 KOVOVÉ ÚCHYTKY

7 ÚCHYTKY, VĚŠÁKY A PROFILY

LESA



chrom lesklý



nikl jemně broušený

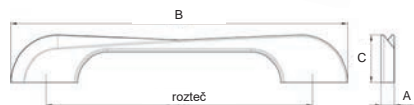

BAREVNÉ PŘÍKRYTÍ	ROZTEČ	B	A	C	KÓD
chrom lesklý	160	203	8	28	802104
	224	267	8	28	802106
nikl jemně broušený	160	203	8	28	802105
	224	267	8	28	802107

ALBA



staromosaz



chrom lesklý

nikl jemně broušený

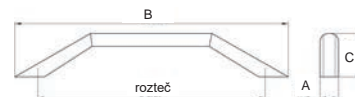

BAREVNÉ PŘÍKRYTÍ	ROZTEČ	B	A	C	KÓD
chrom lesklý	128	154	11	25	802074
nikl jemně broušený	128	154	11	25	802076
staromosaz	128	154	11	25	802075

HRAZDA 12

BAREVNÉ PŘÍKRYTÍ	ROZTEČ	B	A	C	KÓD
černá	96	156	12	31	763585
	128	188	12	31	763586
	160	220	12	31	762447
	192	272	12	31	763587
	224	304	12	31	763589
	320	400	12	31	763593
	448	528	12	31	763595
chrom lesklý	576	656	12	31	763596
	96	156	12	31	473948
	128	188	12	31	473949
	160	220	12	31	473950
	192	272	12	31	473951
	224	304	12	31	473952
	320	400	12	31	473953
chrom matný	448	528	12	31	473954
	640	720	12	31	696584
	96	156	12	31	471837
	128	188	12	31	471839
	160	220	12	31	471841
	192	272	12	31	471843
	224	304	12	31	471845
nikl broušený	320	400	12	31	471847
	448	528	12	31	471849
	576	656	12	31	471851
	640	720	12	31	471853
	736	856	12	31	471855
	800	920	12	31	471859
	96	156	12	31	473955
nikl satén	128	188	12	31	473956
	160	220	12	31	473957
	192	272	12	31	473958
	224	304	12	31	473959
	320	400	12	31	473960
	416	496	12	31	581280
	448	528	12	31	473961
chrom lesklý	480	560	12	31	581282
	576	656	12	31	473962
	640	720	12	31	473963
	736	856	12	31	473964
	800	920	12	31	473965
	96	156	12	31	471838
	128	188	12	31	471840
chrom matný	160	220	12	31	471842
	192	272	12	31	471844
	224	304	12	31	471846
	320	400	12	31	471848
	448	528	12	31	471850
	576	656	12	31	471852
	640	720	12	31	471854
nikl broušený	736	856	12	31	471857
	800	920	12	31	471858



černá

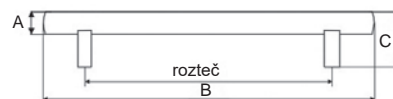

chrom lesklý

chrom matný

nikl broušený

nikl satén

7.1 KOVOVÉ ÚCHYTKY

7 ÚCHYTKY, VĚŠÁKY A PROFILY

HRAZDA 10

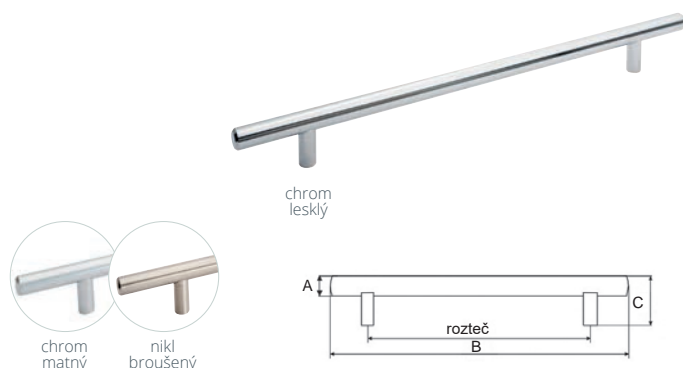

BAREVNÉ PŘÍKRYTÍ	ROZTEČ	B	A	C	KÓD
chrom lesklý	96	156	10	32	518853
	128	188	10	32	518854
	160	220	10	32	518855
chrom matný	96	156	10	32	518850
	128	188	10	32	518851
nikl broušený	96	156	10	32	518847
	128	188	10	32	518848

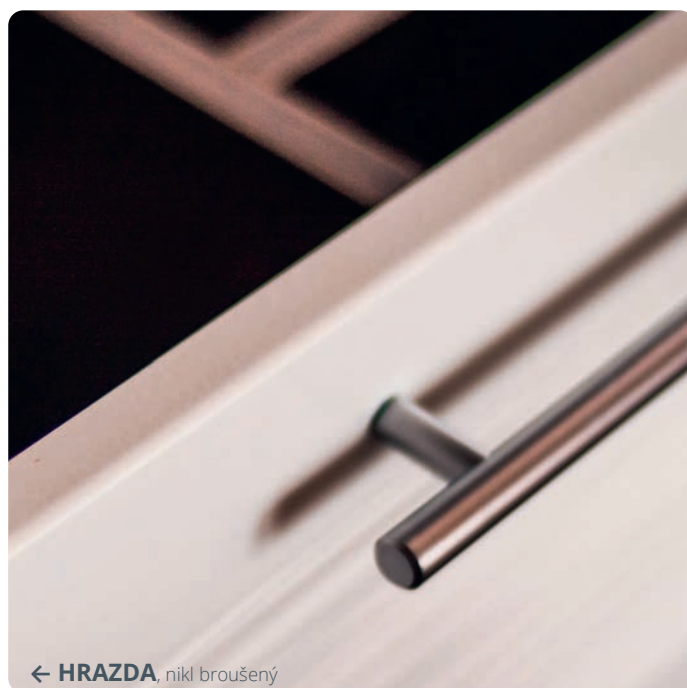

← HRAZDA, nikl broušený

REBEKA

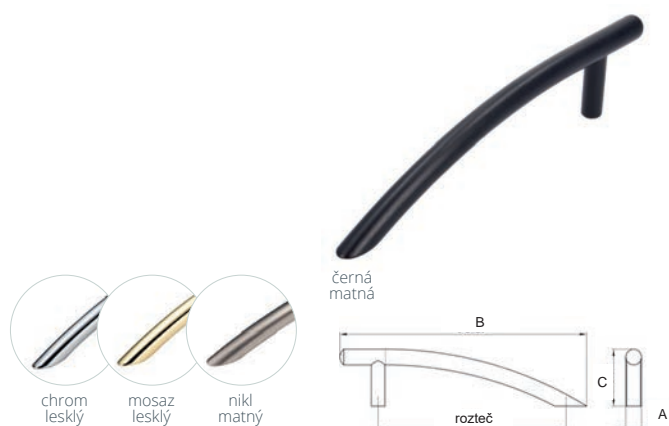

BAREVNÉ PŘÍKRYTÍ	ROZTEČ	B	A	C	KÓD
černá matná	96	126	8	29	802133
chrom lesklý	96	126	8	29	802134
mosaz lesklý	96	126	8	29	802136
nikl matný	96	126	8	29	802135

JOVANA

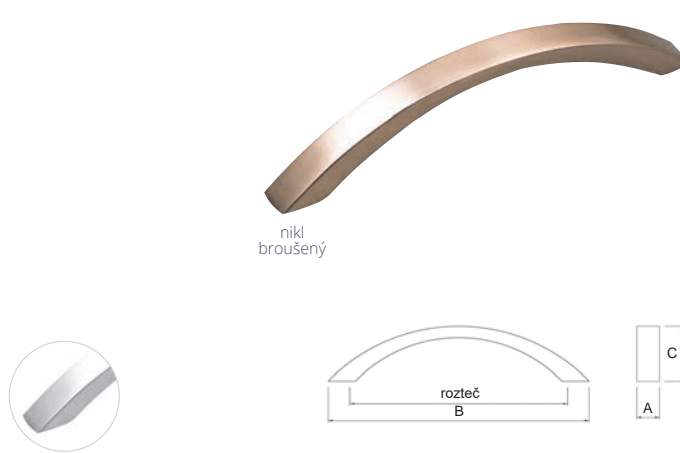

BAREVNÉ PŘÍKRYTÍ	ROZTEČ	B	A	C	KÓD
chrom satén	128	150	10	27	344329
nikl broušený	128	150	10	27	344328

LORA

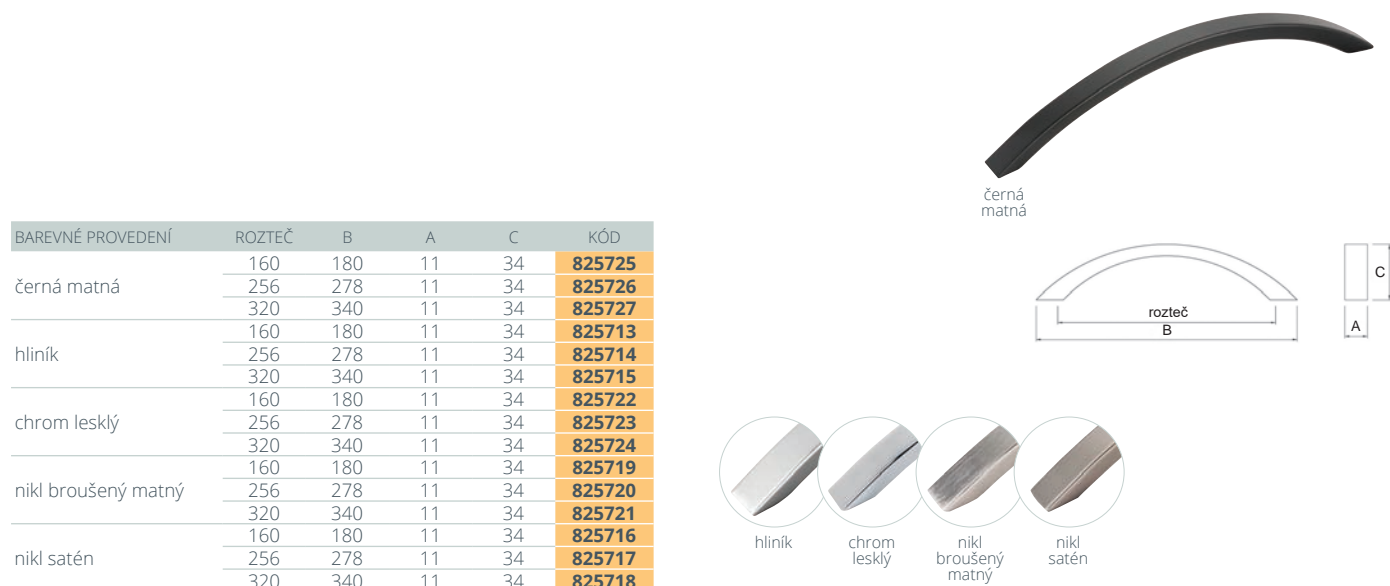

BAREVNÉ PŘÍKRYTÍ	ROZTEČ	B	A	C	KÓD
černá matná	160	180	11	34	825725
	256	278	11	34	825726
	320	340	11	34	825727
hliník	160	180	11	34	825713
	256	278	11	34	825714
	320	340	11	34	825715
chrom lesklý	160	180	11	34	825722
	256	278	11	34	825723
	320	340	11	34	825724
nikl broušený matný	160	180	11	34	825719
	256	278	11	34	825720
	320	340	11	34	825721
nikl satén	160	180	11	34	825716
	256	278	11	34	825717
	320	340	11	34	825718

7.1 KOVOVÉ ÚCHYTKY

7 ÚCHYTKY, VĚŠÁKY A PROFILY

UGO



nikl satén

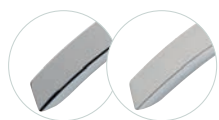

chrom lesklý
chrom satén

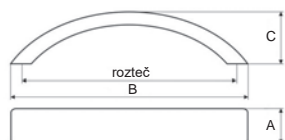

BAREVNÉ PROVEDENÍ	ROZTEČ	B	A	C	KÓD
chrom lesklý	128	145	20	30	676918
chrom satén	128	145	20	30	413452
nikl satén	128	145	20	30	063601

BALMO



nerex



chrom satén

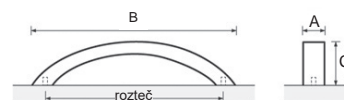

BAREVNÉ PROVEDENÍ	ROZTEČ	B	A	C	KÓD
chrom satén	128	149	15	32	062518
nerex	128	149	15	32	071527

ZORA



černá matná broušená

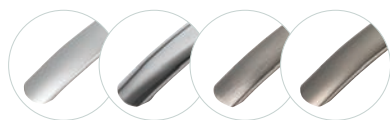

hliník
chrom lesklý
nikl broušený matný
nikl satén

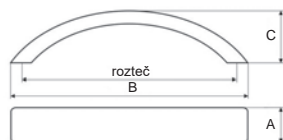

BAREVNÉ PROVEDENÍ	ROZTEČ	B	A	C	KÓD
černá matná broušená	160	180	15	32	825703
hliník	160	180	15	32	825699
chrom lesklý	160	180	15	32	825702
nikl broušený-matný	160	180	15	32	825701
nikl satén	160	180	15	32	825700

DALIA



chrom lesklý

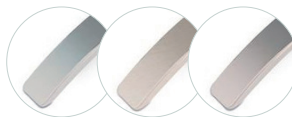

chrom matný
nikl jemně broušený
nikl matný

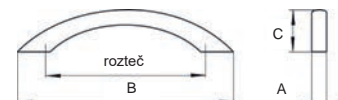

BAREVNÉ PROVEDENÍ	ROZTEČ	B	A	C	KÓD
chrom lesklý	128	146	15	30	047387
chrom matný	128	146	15	30	011655
nikl jemně broušený	128	146	15	30	038940
nikl matný	128	146	15	30	054981

VERONICA

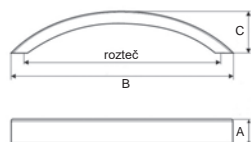

CATARINA

BAREVNÉ PROVEDENÍ	ROZTEČ	B	A	C	KÓD
nikl broušený	128	144	15	30	365353

PARMA



nerex
finiš



chrom lesklý

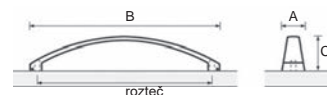

BAREVNÉ PROVEDENÍ	ROZTEČ	B	A	C	KÓD
chrom lesklý	128	138	17	25	351045
nerex finiš	128	138	17	25	351075

7.1 KOVOVÉ ÚCHYTKY 7 ÚCHYTKY, VĚŠÁKY A PROFILY

SÁRA

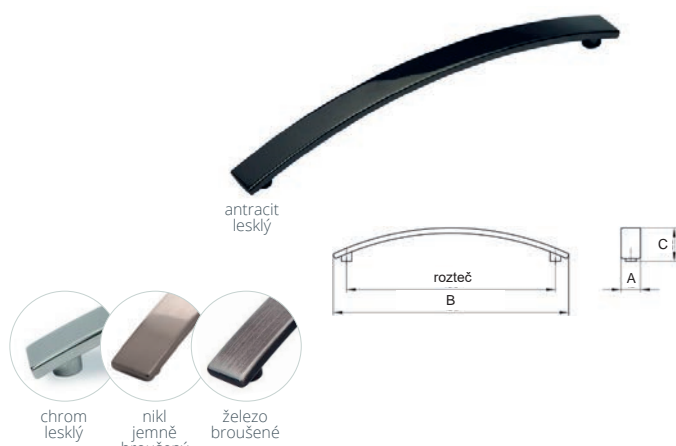

BAREVNÉ PŘÍKRYTÍ	ROZTEČ	B	A	C	KÓD
antracit lesklý	160	181	15	25,5	647892
chrom lesklý	160	181	15	25,5	772698
nikl jemně broušený	160	181	15	25,5	567343
železo broušené	160	181	15	25,5	723340



← SÁRA, antracit lesklý

MIA

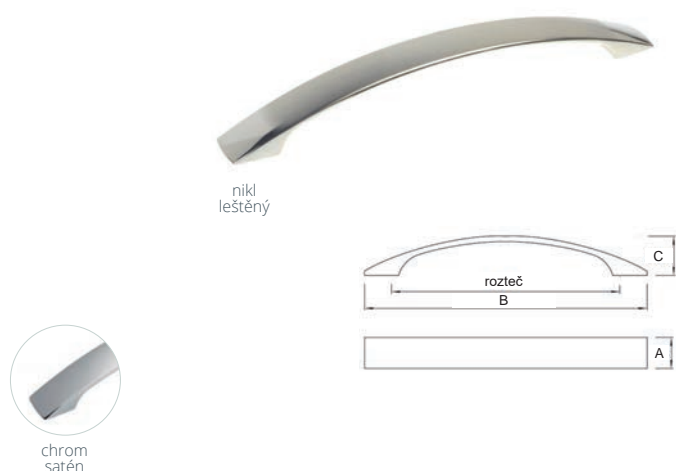

BAREVNÉ PŘÍKRYTÍ	ROZTEČ	B	A	C	KÓD
chrom satén	160	180	21	25	413558
nikl leštěný	160	180	21	25	413560

MARINA

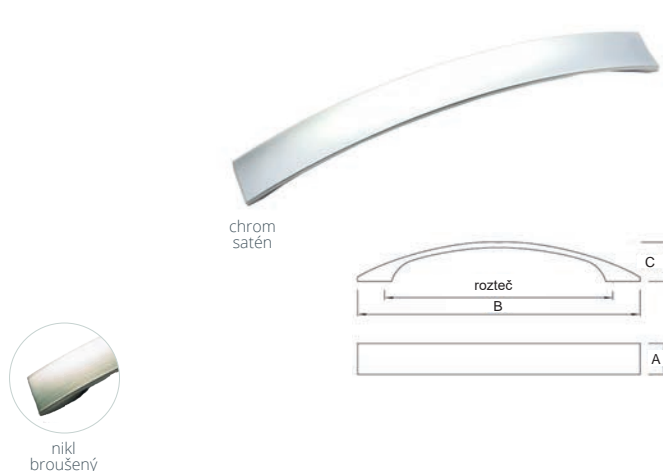

BAREVNÉ PŘÍKRYTÍ	ROZTEČ	B	A	C	KÓD
chrom satén	160	198	22	27,5	344327
nikl broušený	160	198	22	27,5	344326

MONICA



BAREVNÉ PŘÍKRYTÍ	ROZTEČ	B	A	C	KÓD
černá matná	96	138	20	24	861427
	128	184	20	24	861426
chrom lesklý	96	138	20	24	011443
	128	184	20	24	103439
chrom satén	96	138	20	24	011444
	128	184	20	24	063629
nikl broušený	96	138	20	24	035251
	128	184	20	24	011445
nikl satén	96	138	20	24	011513
	128	184	20	24	021520

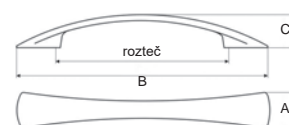

7.1 KOVOVÉ ÚCHYTKY

7 ÚCHYTKY, VĚŠÁKY A PROFILY

CRISTINA

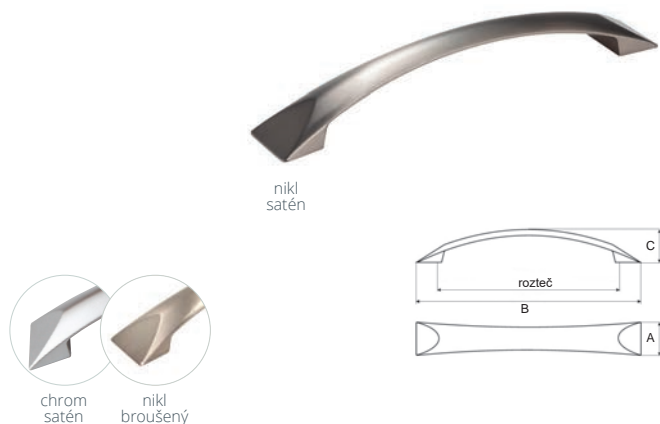

BAREVNÉ PŘÍKRYTÍ	ROZTEČ	B	A	C	KÓD
chrom satén	128	156	23	23	185738
nikl broušený	128	156	23	23	365350
nikl satén	128	156	23	23	145966

LAURA

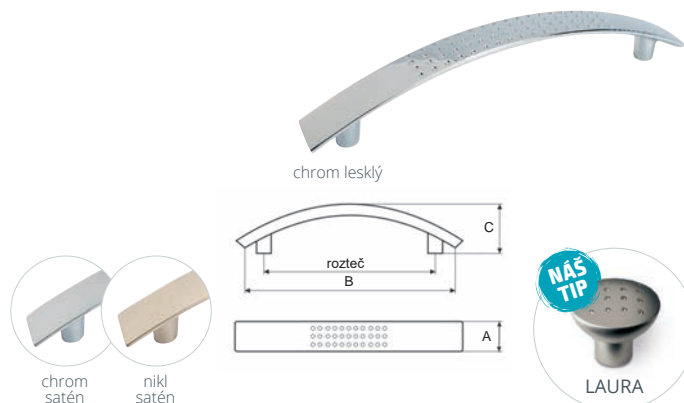

BAREVNÉ PŘÍKRYTÍ	ROZTEČ	B	A	C	KÓD
chrom lesklý	96	124	17,5	27	037986
	128	156	17,5	27	056895
chrom satén	96	124	17,5	27	063622
	128	156	17,5	27	063624
nikl satén	96	124	17,5	27	011512
	128	156	17,5	27	063623

KAROLÍNA

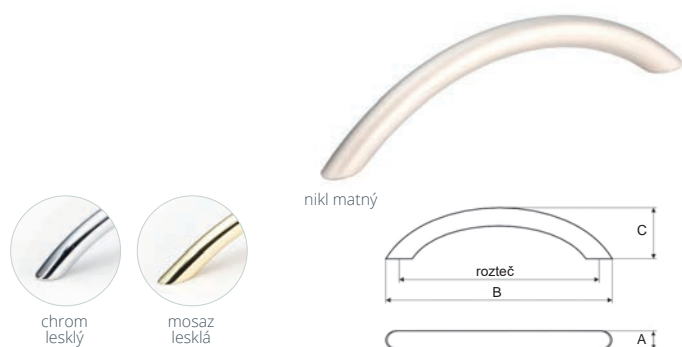

BAREVNÉ PŘÍKRYTÍ	ROZTEČ	B	A	C	KÓD
chrom lesklý	96	108	8	24	823046
	128	154	10	28	823048
nikl matný	96	108	8	24	823047
	128	154	10	28	823049
mosaz lesklá	128	154	10	28	823050

SALOME

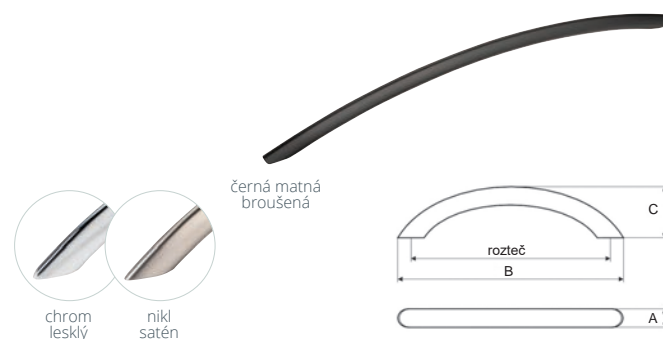

BAREVNÉ PŘÍKRYTÍ	ROZTEČ	B	A	C	KÓD
černá matná - broušená	160	190	9	38	825710
	256	292	9	38	825711
	320	356	9	38	825712
chrom lesklý	160	190	9	38	825707
	256	292	9	38	825708
	320	356	9	38	825709
nikl satén	160	190	9	38	825704
	256	292	9	38	825705
	320	356	9	38	825706

ANABEL



BAREVNÉ PŘÍKRYTÍ	ROZTEČ	B	A	C	KÓD
nerezová ocel černá	128	145	10	35	859436
	192	223	10	35	859437
	320	371	10	35	859438

BASILIA II



BAREVNÉ PŘÍKRYTÍ	ROZTEČ	B	A	C	KÓD
černá	128	164	12	25	762783
chrom lesklý	96	121	10,5	22	909135
	128	158	10,5	22	909138
chrom satén	96	121	10,5	22	909136
	128	158	10,5	22	909139
nikl satén	96	121	10,5	22	909137
	128	158	10,5	22	909140

7.1 KOVOVÉ ÚCHYTKY 7 ÚCHYTKY, VĚŠÁKY A PROFILY

BETA II

BAREVNÉ PROVEDENÍ	ROZTEČ	B	A	C	KÓD
černá matná	96	115	10	30	911182
	128	151	10	30	911183
	160	190	10	30	911183
chrom lesklý	96	115	10	30	910000
	128	151	10	30	911174
	160	190	10	30	911175
chrom satén	96	115	10	30	911172
	128	151	10	30	903622
	160	190	10	30	911173
nikl broušený	96	115	10	30	911179
	128	151	10	30	911180
	160	190	10	30	911181
nikl satén	96	115	10	30	911176
	128	151	10	30	911177
	160	190	10	30	911178
bílá lesklá	96	115	10	30	911185
	128	151	10	30	911186
	160	190	10	30	911187



černá matná

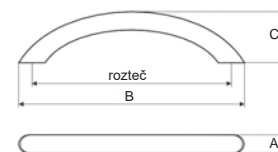

chrom lesklý chrom satén nikl broušený nikl satén bílá lesklá

MARIA

BAREVNÉ PROVEDENÍ	ROZTEČ	B	A	C	KÓD
bílá	96	115	8	23	063635
	96	115	8	23	063634
černá	128	156	8	23	391043
chrom lesklý	96	115	8	23	063631
	128	156	8	23	056942
chrom satén	96	115	8	23	063633
	128	156	8	23	063630
mosaz	96	115	8	23	011514
	128	156	8	23	078124
nikl broušený	96	115	8	23	063632
	128	156	8	23	117401
nikl satén	96	115	8	23	011515
	128	156	8	23	097443



mosaz

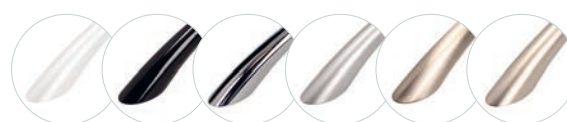
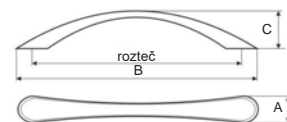

bílá černá chrom lesklý chrom satén nikl broušený nikl satén

CORIA



nerez kartáčovaný

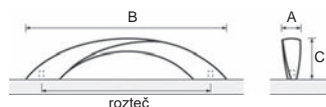

chrom lesklý chrom matný nikl matný

BAREVNÉ PROVEDENÍ	ROZTEČ	B	A	C	KÓD
chrom lesklý	128	151	16	34	714295
chrom matný	128	151	16	34	351151
nerez kartáčovaný	128	151	16	34	344713
nikl matný	128	151	16	34	351150

GABRIELLA II



chrom lesklý

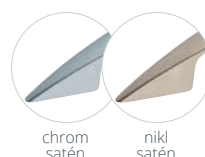
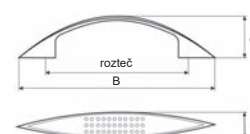

chrom satén nikl satén



BAREVNÉ PROVEDENÍ	ROZTEČ	B	A	C	KÓD
chrom lesklý	96	132	14	25	909487
	128	164	14	25	909490
chrom satén	96	132	14	25	909488
	128	164	14	25	909491
nikl satén	96	132	14	25	909489
	128	164	14	25	909492

7.1 KOVOVÉ ÚCHYTKY

7 ÚCHYTKY, VĚŠÁKY A PROFILY

JULIE



černá matná



chrom lesklý
nikl broušený

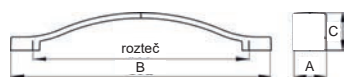

BAREVNÉ PŘEVODENÍ	ROZTEČ	B	A	C	KÓD
černá matná	160	230	18	27	825687
chrom lesklý	160	230	18	27	825688
nikl broušený	160	230	18	27	825689



GENOA



nerez
finiš



chrom lesklý

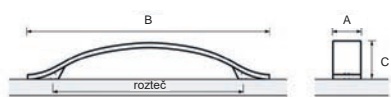

BAREVNÉ PŘEVODENÍ	ROZTEČ	B	A	C	KÓD
chrom lesklý	128	170	23	26	160772
nerez finiš	128	170	23	26	160796

LORI



ALU efekt



chrom lesklý
nikl jemně broušený



BAREVNÉ PŘEVODENÍ	ROZTEČ	B	A	C	KÓD
ALU efekt	160	193	24	28	118448
chrom lesklý	160	193	24	28	571475
nikl jemně broušený	160	193	24	28	117939

ANGELA



chrom lesklý



chrom satén
nikl satén

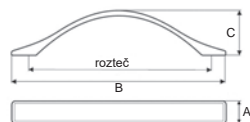

ANGELA

BAREVNÉ PŘEVODENÍ	ROZTEČ	B	A	C	KÓD
chrom lesklý	96	115	13	25	365338
chrom satén	96	115	13	25	365340
nikl satén	96	115	13	25	365339

SERENA

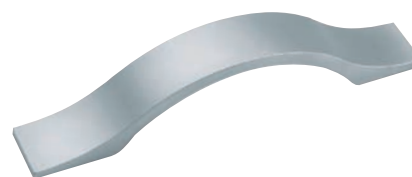

chrom satén



nikl broušený

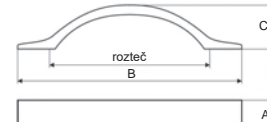

SERENA

BAREVNÉ PŘEVODENÍ	ROZTEČ	B	A	C	KÓD
chrom satén	96	140	20	29	217250
nikl broušený	96	140	20	29	365349

7.1 KOVOVÉ ÚCHYTKY

7 ÚCHYTKY, VĚŠÁKY A PROFILY

LINE



antracit matný

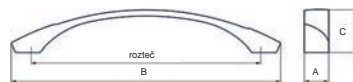

BAREVNÉ PŘÍKRYTÍ	ROZTEČ	B	A	C	KÓD
antracit matný	160	188	17	29	754617
	320	348	17	30	754615
ušlechtilá ocel matná	160	188	17	29	754616
	320	348	17	30	754614



NINA



černá měď
mosaz ručně broušená
nikl jemně broušený
železo broušené

BAREVNÉ PŘÍKRYTÍ	ROZTEČ	B	A	C	KÓD
černá měď	160	180	25	29	875206
	320	340	25	29	870677
mosaz ručně broušená	160	180	25	29	770913
	320	340	25	29	751790
nikl jemně broušený	160	180	25	29	692227
	320	340	25	29	687655
ušlechtilá ocel mat	160	180	25	29	719958
	320	340	25	29	719957
železo broušené	160	180	25	29	737152
	320	340	25	29	707114



ušlechtilá ocel mat



SALONA

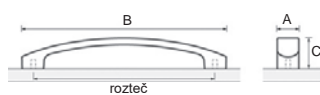

BAREVNÉ PŘÍKRYTÍ	ROZTEČ	B	A	C	KÓD
nerez finiš	160	180	19	27	351098

DINIA



nerez finiš



chrom satén

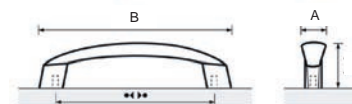

BAREVNÉ PŘÍKRYTÍ	ROZTEČ	B	A	C	KÓD
chrom satén	96	118	16	28	029806
	128	143	18	29	029838
nerez finiš	96	118	16	28	029805
	128	143	18	29	029872

7.1 KOVOVÉ ÚCHYTKY

7 ÚCHYTKY, VĚŠÁKY A PROFILY

ALESSANDRA



chrom
satén

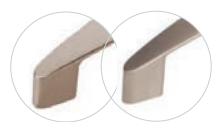

nikl
broušený

nikl
satén

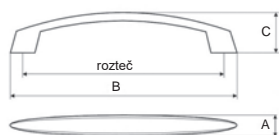

rozteč

C

B

A

BAREVNÉ PŘÍKRYTÍ	ROZTEČ	B	A	C	KÓD
chrom satén	128	140	17	25	011455
nikl broušený	128	140	17	25	063604
nikl satén	128	140	17	25	011582

BRIGITA



chrom
satén

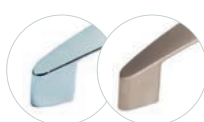

chrom
lesklý

nikl
satén

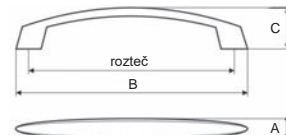

rozteč

C

B

A

BAREVNÉ PŘÍKRYTÍ	ROZTEČ	B	A	C	KÓD
chrom lesklý	96	108	17	25	063606
chrom satén	96	108	17	25	063607
nikl satén	96	108	17	25	011456

FECTIO



nerez
kartáčovaný



chrom
matný

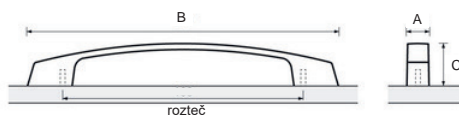

B

A

C

rozteč

BAREVNÉ PŘÍKRYTÍ	ROZTEČ	B	A	C	KÓD
chrom matný	160	210	15	29	351230
nerez kartáčovaný	160	210	15	29	351231

VANTANIA



chrom
matný



chrom
lesklý

nerez
finiš

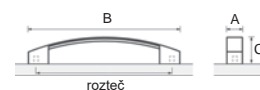

B

A

C

rozteč

BAREVNÉ PŘÍKRYTÍ	ROZTEČ	B	A	C	KÓD
chrom lesklý	128	144	14	27	350979
chrom matný	128	144	14	27	350990
nerez finiš	128	144	14	27	350989

SIERA



nikl jemně
broušený

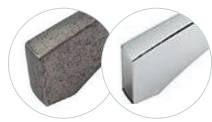

antik ocel
efekt

chrom
lesklý

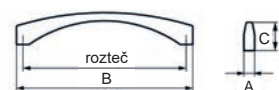

rozteč

C

A

BAREVNÉ PŘÍKRYTÍ	ROZTEČ	B	A	C	KÓD
antik ocel efekt	160	173	12	31	669891
antik ocel efekt	320	333	12	31	662423
chrom lesklý	160	173	12	31	414307
chrom lesklý	320	333	12	31	426906
nikl jemně broušený	160	173	12	31	409755
nikl jemně broušený	320	333	12	31	409757



← SIERA, antik ocel efekt

7.1 KOVOVÉ ÚCHYTKY 7 ÚCHYTKY, VĚŠÁKY A PROFILY

VALEDA

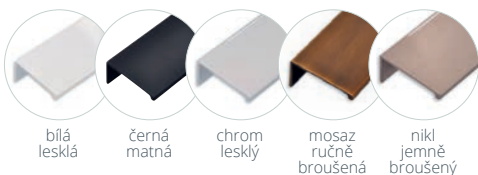

bílá
lesklá

černá
matná

chrom
lesklý

mosaz
ručně
broušená

nikl
jemně
broušený

BAREVNÉ PŘÍČINĚNÍ	ROZTEČ	B	A	C	KÓD
bílá lesklá	48	70	40	20	763888
	128	145	40	20	787891
černá matná	48	70	40	20	763892
	128	145	40	20	787892
chrom lesklý	48	70	40	20	831575
	128	145	40	20	787897
mosaz ručně broušená	48	70	40	20	787893
	128	145	40	20	762151
nikl jemně broušený	48	70	40	20	787894
	128	145	40	20	755900
železo broušené	48	70	40	20	787895
	128	145	40	20	751451
	288	320	40	20	787896
					845230



železo
broušené

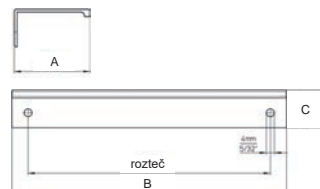

ZITA

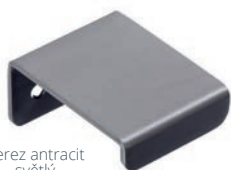

neraz antracit
světlý



neraz

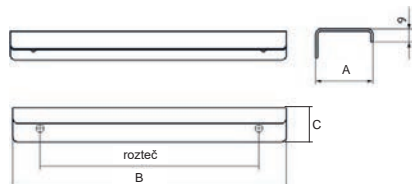

BAREVNÉ PŘÍČINĚNÍ	ROZTEČ	B	A	C	KÓD
neraz antracit světlý	16	32	40	20	881411
	64	96	40	20	868204
	160	192	40	20	862348
neraz	16	32	40	20	716126
	64	96	40	20	860030
	160	192	40	20	709488

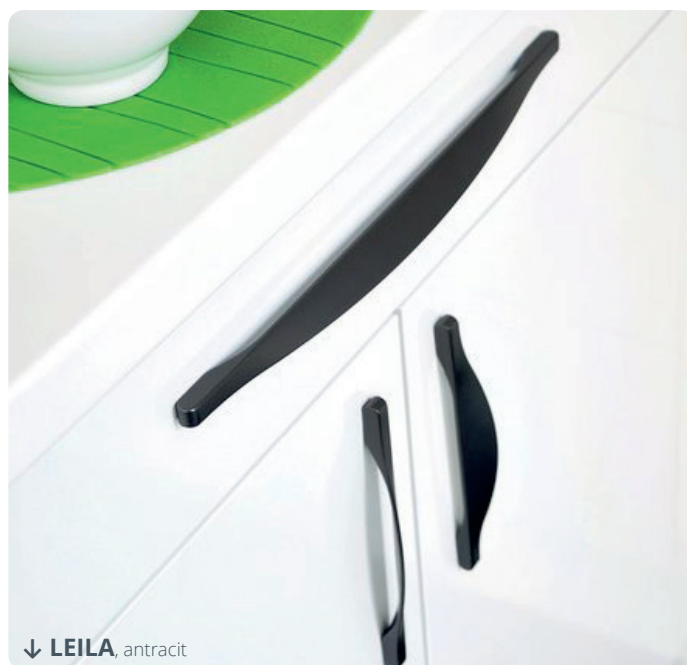

↓ LEILA, antracit

LEILA

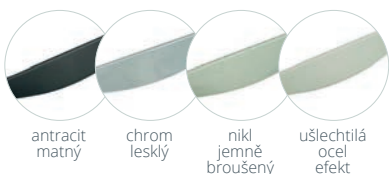

antracit
matný

chrom
lesklý

nikl
jemně
broušený

ušlechtilá
ocel
efekt

BAREVNÉ PŘÍČINĚNÍ	ROZTEČ	B	A	C	KÓD
antracit	160	185	18	23	751480
	320	339	18	24	751476
antracit matný	160	185	18	23	683359
	320	339	18	24	738532
chrom lesklý	160	185	18	23	698446
	320	339	18	24	681674
nikl jemně broušený	160	185	18	23	671386
	320	339	18	24	674187
ušlechtilá ocel efekt	160	185	18	23	674186
	320	339	18	24	693491



antracit

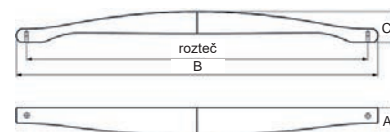

7.1 KOVOVÉ ÚCHYTKY

7 ÚCHYTKY, VĚŠÁKY A PROFILY

KAIRA



černá matná nikl jemně broušený starozlatá

BAREVNÉ PROVEDENÍ	ROZTEČ	B	A	C	KÓD
černá matná	64	94	16	20	787879
	160	190	16	20	787870
	320	350	16	20	787875
nikl jemně broušený	64	94	16	20	787881
	160	190	16	20	787872
	320	350	16	20	787877
starozlatá	64	94	16	20	787882
	160	190	16	20	787873
	320	350	16	20	787878
železo broušené	64	94	16	20	787883
	160	190	16	20	787874



železo broušené



→ VIKI, černá matná

VIKI



bílá matná ušlechtilá ocel mat



černá matná

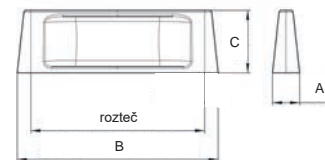

BAREVNÉ PROVEDENÍ	ROZTEČ	B	A	C	KÓD
bílá matná	64	74	10	23	859459
	64	74	10	23	859460
černá matná	128	138	10	23	859455
	192	202	10	23	859457
	64	74	10	23	859461
ušlechtilá ocel mat	128	138	10	23	859456
	192	202	10	23	859458

ROVIGO

BAREVNÉ PROVEDENÍ	ROZTEČ	B	A	C	KÓD
hliník eloxovaný	64	79	16	25	664650
	96	111	16	25	666623
	128	143	16	25	666625
	160	175	16	25	666627
	192	207	16	25	666629
	224	239	16	25	666631
chrom lesklý	8x 224 (ke krácení)	2 000	16	25	666633
	64	79	16	25	664648
	96	111	16	25	666613
	128	143	16	25	666614
	160	175	16	25	351149
	192	207	16	25	666615
nerez kartáčovaný	224	239	16	25	351295
	64	79	16	25	664649
	96	111	16	25	666617
	128	143	16	25	666619
	160	175	16	25	351112
	192	207	16	25	666621
	224	239	16	25	351205



chrom lesklý

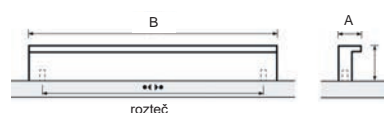

hliník eloxovaný nerez kartáčovaný

7.1 KOVOVÉ ÚCHYTKY 7 ÚCHYTKY, VĚŠÁKY A PROFILY

MEDILA



BAREVNÉ PROVEDENÍ	ROZTEČ	B	A	C	KÓD
černá matná	192	250	10	25	843445
	448	500	10	25	843446
	576/704	760	10	25	836288
chrom lesklý	192	250	10	25	802113
	448	500	10	25	802114
	576/704	760	10	25	802115



ISANA

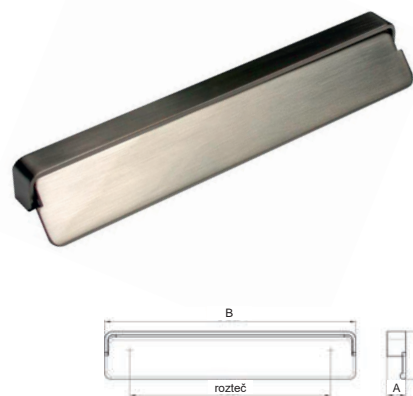

BAREVNÉ PROVEDENÍ	ROZTEČ	B	A	C	KÓD
nikl jemně broušený	128	160	12	30	802088

SÁVA

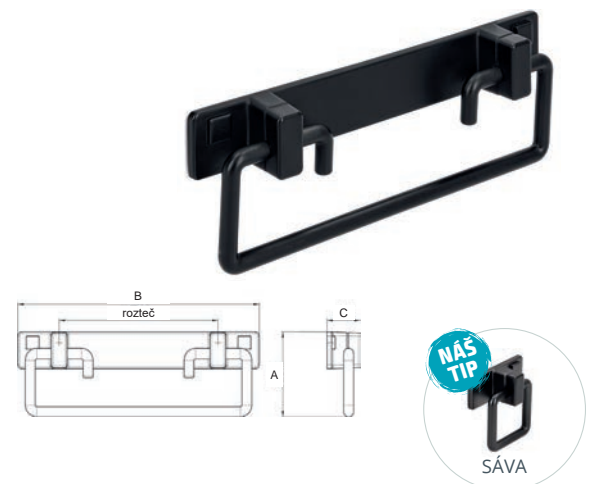

BAREVNÉ PROVEDENÍ	ROZTEČ	B	A	C	KÓD
černá matná	96	146	51	20	787887

7.2 RUSTIKÁLNÍ ÚCHYTKY

SPARTA II



nikl patina



mosaz patina
nikl leštěný černý

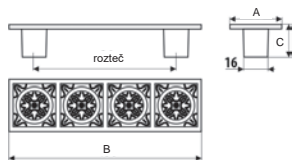

BAREVNÉ PŘÍKRYTÍ	ROZTEČ	B	A	C	KÓD
mosaz patina	96	130	35	22	861562
nikl leštěný černý	96	130	35	22	861563
nikl patina	96	130	35	22	861561

TORA



grafit
stříbro antik



měď antik

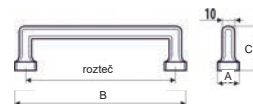

BAREVNÉ PŘÍKRYTÍ	ROZTEČ	B	A	C	KÓD
grafit	128	146	18	37	853574
	160	178	18	37	853577
	320	338	18	37	853579
měď antik	128	146	18	37	853572
	160	178	18	37	853575
	320	338	18	37	853578
stříbro antik	128	146	18	37	853573
	160	178	18	37	853576

ZAIRA



ZAIRA



železo černé patina



cínová
mosaz ručně broušená

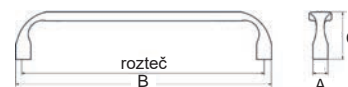

BAREVNÉ PŘÍKRYTÍ	ROZTEČ	B	A	C	KÓD
cínová	160	170	15	31	787905
mosaz ručně broušená	160	170	15	31	787906
železo černé patina	160	170	15	31	753253

→ ZAIRA, mosaz ručně broušená

SALACIA



cínová



stříbrná antik

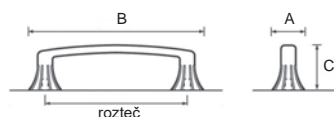

BAREVNÉ PŘÍKRYTÍ	ROZTEČ	B	A	C	KÓD
cínová	128	151	23	30	351132
stříbrná antik	128	151	23	30	350406

CORDUBA

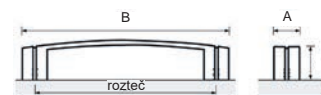

BAREVNÉ PŘÍKRYTÍ	ROZTEČ	B	A	C	KÓD
cínová	128	146	18	28	043753

7.2 RUSTIKÁLNÍ ÚCHYTKY 7 ÚCHYTKY, VĚŠÁKY A PROFILY

VIENA



starostříbrná



staromosaz

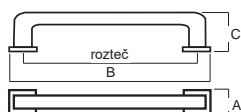

BAREVNÉ PŘÍKRYTÍ	ROZTEČ	B	A	C	KÓD
staromosaz	96	110	13	34	646957
starostříbrná	96	110	13	34	625728

JOLANA



nikl
matný



chrom
satén nikl jemně
broušený



BAREVNÉ PŘÍKRYTÍ	ROZTEČ	B	A	C	KÓD
chrom satén	96	133	20	24	823017
nikl jemně broušený	96	133	20	24	823018
nikl matný	96	133	20	24	823019

ALIDA



AGLIA

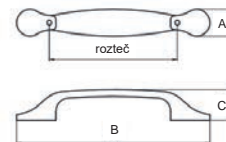
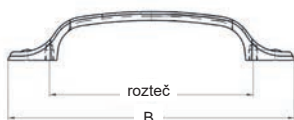

BAREVNÉ PŘÍKRYTÍ	ROZTEČ	B	A	C	KÓD
staromosaz	96	135	13	23	118911

BAREVNÉ PŘÍKRYTÍ	ROZTEČ	B	A	C	KÓD
staromosaz kartáčovaná	96	145	20	22	196411

VERONA



staromosaz



starostříbrná

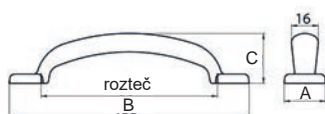

BAREVNÉ PŘÍKRYTÍ	ROZTEČ	B	A	C	KÓD
staromosaz	96	136	20	25	685576
starostříbrná	96	136	20	25	523963



← VERONA, starostříbrná

7.2 RUSTIKÁLNÍ ÚCHYTKY

7 ÚCHYTKY, VĚŠÁKY A PROFILY

ADINA

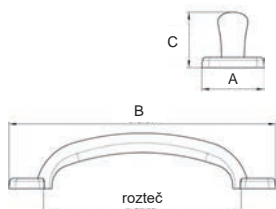
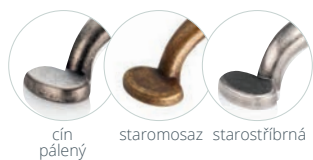

BAREVNÉ PŘÍKRYTÍ	ROZTEČ	B	A	C	KÓD
cín pálený	96	130	30	27	802079
černá matná	96	130	30	27	802078
staromosaz	96	130	30	27	751259
starostříbrná	96	130	30	27	774535

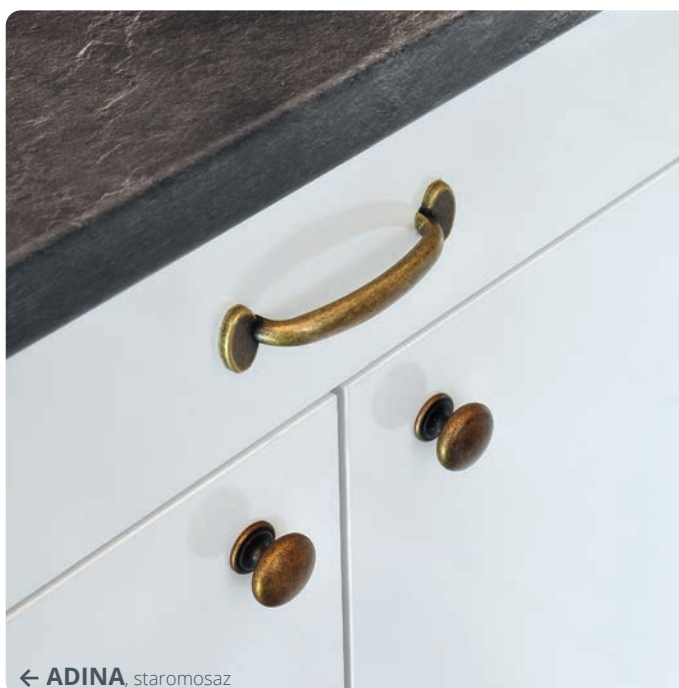

ALBERTA

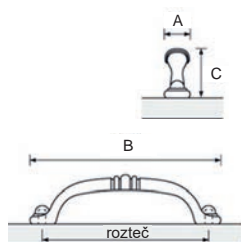

BAREVNÉ PŘÍKRYTÍ	ROZTEČ	B	A	C	KÓD
cín antik	96	110	14	28	350958
mosaz antik	96	110	14	28	350957
nerez finiš	96	110	14	28	350959

ROSA

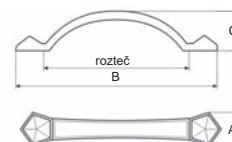

BAREVNÉ PŘÍKRYTÍ	ROZTEČ	B	A	C	KÓD
mosaz patina	96	120	23	25,5	365357
nikl patina	96	120	23	25,5	365358

RITA

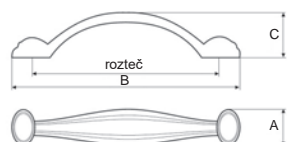

BAREVNÉ PŘÍKRYTÍ	ROZTEČ	B	A	C	KÓD
mosaz patina	96	110	18	22	365359
nikl černý / mosaz	96	110	18	22	674349
nikl patina	96	110	18	22	365360

HAIDA

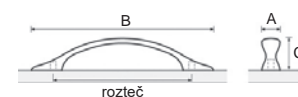
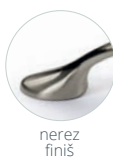

BAREVNÉ PŘÍKRYTÍ	ROZTEČ	B	A	C	KÓD
mosaz antik	96	126	13	22	350882
nerez finiš	96	126	13	22	350907

7.2 RUSTIKÁLNÍ ÚCHYTKY 7 ÚCHYTKY, VĚŠÁKY A PROFILY

STELA

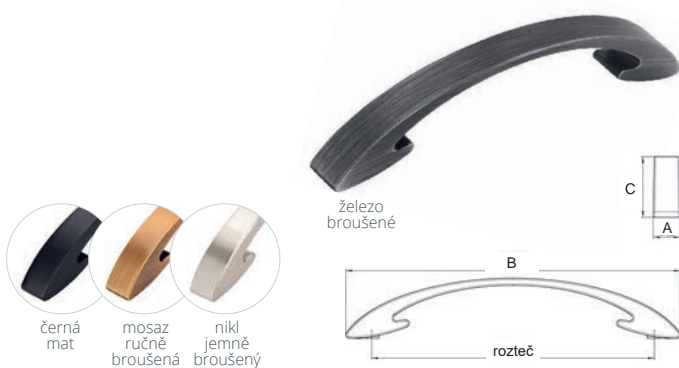

BAREVNÉ PŘÍKRYTÍ	ROZTEČ	B	A	C	KÓD
černá matná	128	151	15	34	859447
	160	189	15	34	859451
mosaz ručně broušená	128	151	15	34	859448
	160	189	15	34	859452
nikl jemně broušený	128	151	15	34	859449
	160	189	15	34	859453
železo broušené	128	151	15	34	859450
	160	189	15	34	859454



EGARA

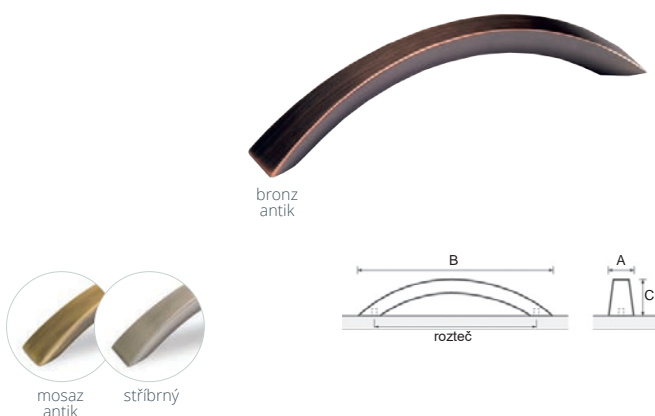

BAREVNÉ PŘÍKRYTÍ	ROZTEČ	B	A	C	KÓD
bronz antik	128	155	20	30	160739
mosaz antik	128	155	20	30	160740
stříbrný antik	128	155	20	30	160741

VESNA

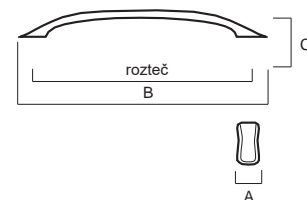

BAREVNÉ PŘÍKRYTÍ	ROZTEČ	B	A	C	KÓD
staromosaz kartáčovaná	96	144	24	24	352669

ALINA



BAREVNÉ PŘÍKRYTÍ	ROZTEČ	B	A	C	KÓD
	128	142	13	26	825672
bronz broušený	160	174	13	26	825673
	320	334	13	26	825674
černá matná	128	142	13	26	825666
	160	174	13	26	825667
	320	334	13	26	825668
chrom lesklý	128	142	13	26	825669
	160	174	13	26	825670
	320	334	13	26	825671
nikl broušený	128	142	13	26	825675
	160	174	13	26	825676
	320	334	13	26	825677

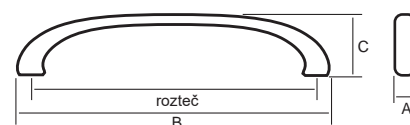

7.2 RUSTIKÁLNÍ ÚCHYTKY

7 ÚCHYTKY, VĚŠÁKY A PROFILY

NATÁLIA



mosaz lesklá



nikl matný

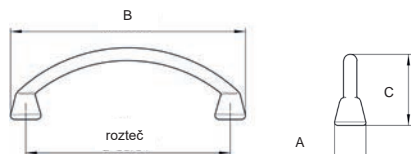

BAREVNÉ PŘÍKRYTÍ	ROZTEČ	B	A	C	KÓD
mosaz lesklá	64	74	10	22	802132
nikl matný	64	74	10	22	802131

RIANA

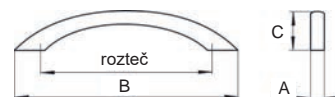

BAREVNÉ PŘÍKRYTÍ	ROZTEČ	B	A	C	KÓD
staromosaz	76	113	14	21	011625

SIENA

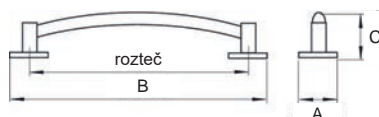

BAREVNÉ PŘÍKRYTÍ	ROZTEČ	B	A	C	KÓD
staromosaz	64	86	22	24	289981
	96	120	25	24	286144

GISSI

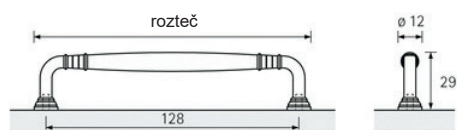

BAREVNÉ PŘÍKRYTÍ	ROZTEČ	B	A	C	KÓD
čínový vzhled	128	140	12	29	351137

ISABEL



SIMON



staromosaz / porcelán s růžovými kvítky



nikl patina / porcelán s modrými kvítky

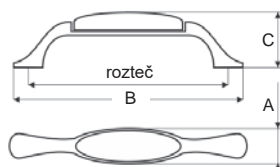

BAREVNÉ PŘÍKRYTÍ	ROZTEČ	B	A	C	KÓD
nikl patina/porcelán s modrými kvítky	96	123	21	31	861560
	128	168	21	31	861559
staromosaz/porcelán s růžovými kvítky	96	123	21	21	861558
	128	168	21	31	861557

DIVERA II



nikl patina / porcelán s kvítky



nikl patina/porcelán

staromosaz/porcelán s lístky

staromosaz/porcelán popraskaný

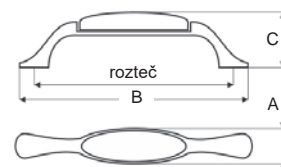

BAREVNÉ PŘÍKRYTÍ	ROZTEČ	B	A	C	KÓD	
nikl patina	porcelán	96	126	19	31	861550
	porcelán s kvítkem	96	126	19	31	861551
	porcelán s lístky	96	126	19	31	861552
	porcelán	96	126	19	31	861553
staromosaz	porcelán popraskaný	96	126	19	31	861556
	porcelán s kvítkem	96	126	19	31	861554
	porcelán s lístky	96	126	19	31	861555

7.2 RUSTIKÁLNÍ ÚCHYTKY 7 ÚCHYTKY, VĚŠÁKY A PROFILY

GRETA

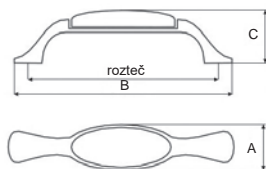

BAREVNÉ PŘÍKRYTÍ	ROZTEČ	B	A	C	KÓD
staromosaz/popraskaný porcelán krémový	96	128	17	28	365355

MARILIN



staromosaz brnír /
plast béžový

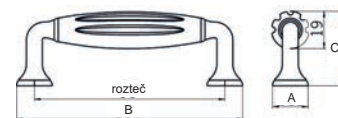

BAREVNÉ PŘÍKRYTÍ	ROZTEČ	B	A	C	KÓD
staromosaz brnír / plast béžový	96	114	18	37,5	186876
zinek / plast bílý	96	114	18	37,5	492923

ARDENIA II



staromosaz /
porcelán s lístky

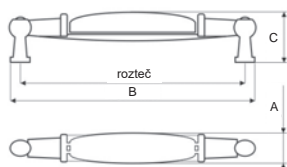

BAREVNÉ PŘÍKRYTÍ	ROZTEČ	B	A	C	KÓD
porcelán	96	107	17	24	861531
nikl patina porcelán s kvítkem	96	107	17	24	861532
porcelán s lístky	96	107	17	24	861533
porcelán	96	107	17	24	861535
staromosaz porcelán popraskaný	96	107	17	24	861538
porcelán s kvítkem	96	107	17	24	861536
porcelán s lístky	96	107	17	24	861537

AMELIA



staromosaz

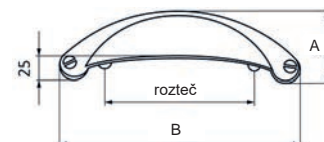

BAREVNÉ PŘÍKRYTÍ	ROZTEČ	B	A	C	KÓD
nikl jemně broušený	64	103	31,5	24,5	294486
staromosaz	64	103	31,5	24,5	286969
ušlechtilá ocel matná	64	103	31,5	24,5	296563
železo broušené	64	103	31,5	24,5	297159



7.3 KNOPKY

7 ÚCHYTKY, VĚŠÁKY A PROFILY

7.3 KNOPKY

ZAIRA

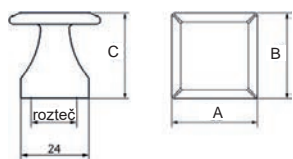

Železo černé patina

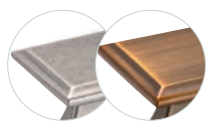

cínová mosaz ručně broušená



ZAIRA

BAREVNÉ PŘÍMĚSÍ	ROZTEČ	B	A	C	KÓD
cínová	16	32	32	30	787863
mosaz ručně broušená	16	32	32	30	779929
železo černé patina	16	32	32	30	771094



← ZAIRA, mosaz ručně broušená

TORA



stříbro antik

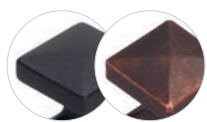

grafit měď antik



TORA



chrom lesklý

BAREVNÉ PŘÍMĚSÍ	B	A	C	KÓD
grafit	25	25	31	853571
měď antik	25	25	31	853569
stříbro antik	25	25	31	853570

MESSANA



nerez finiš

BAREVNÉ PŘÍMĚSÍ	ROZTEČ	B	A	C	KÓD
chrom lesklý	32	42	42	25	160745
nerez finiš	32	42	42	25	159930

ANGELA

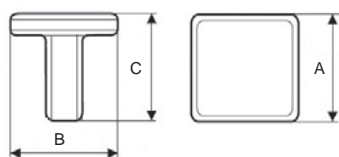

chrom lesklý



chrom satén nikl satén



ANGELA

BAREVNÉ PŘÍMĚSÍ	B	A	C	KÓD
chrom lesklý	20	20	20	365341
chrom satén	20	20	20	365343
nikl satén	20	20	20	365342

SPARTA II

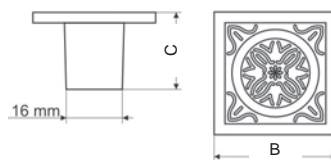

mosaz patina



nikl leštěný černý nikl patina



SPARTA II

BAREVNÉ PŘÍMĚSÍ	B	A	C	KÓD
mosaz patina	35	35	22	861565
nikl leštěný černý	35	35	22	861566
nikl patina	35	35	22	861564

7.3 KNOPKY

7 ÚCHYTKY, VĚŠÁKY A PROFILY

NAVARA

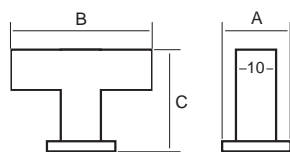

černá matná



chrom lesklý

nikl jemně broušený

BAREVNÉ PŘÍKRYTÍ	B	A	C	KÓD
černá matná	46	18	34	859429
chrom lesklý	46	18	34	859430
nikl jemně broušený	46	18	34	859431



← NAVARA, černá matná

BLOCK

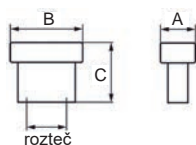

nikl jemně broušený



bílá lesklá

černá matná

chrom lesklý

mosaz jemně broušená

železo broušené

BAREVNÉ PŘÍKRYTÍ	ROZTEČ	B	A	C	KÓD
bílá lesklá	16	29	14	24	787851
černá matná	16	29	14	24	762697
chrom lesklý	16	29	14	24	787852
mosaz ručně broušená	16	29	14	24	787853
nikl jemně broušený	16	29	14	24	116154
železo broušené	16	29	14	24	759727

SÁVA

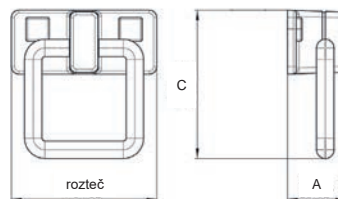

NÁŠ TIP



SÁVA

BAREVNÉ PŘÍKRYTÍ	B	A	C	KÓD
černá matná	51	50	20	787850

QUADROS

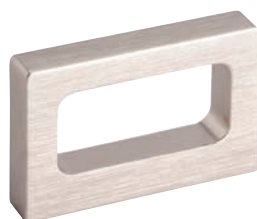

imitace nerezi

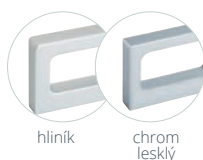

hliník

chrom lesklý

NÁŠ TIP

RADOS

BAREVNÉ PŘÍKRYTÍ	ROZTEČ	B	A	C	KÓD
hliník	32	45	8	30	344281
chrom lesklý	32	45	8	30	344282
imitace nerezi	32	45	8	30	344283

NOEMI

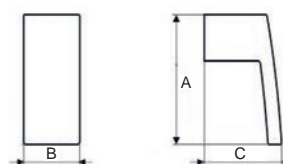

nikl broušený

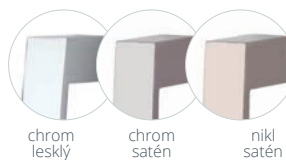

chrom lesklý

chrom satén

nikl satén

NÁŠ TIP

NOEMI

BAREVNÉ PŘÍKRYTÍ	B	A	C	KÓD
chrom lesklý	20	47	28	511015
chrom satén	20	47	28	511017
nikl broušený	20	47	28	754450

7.3 KNOPKY

7 ÚCHYTKY, VĚŠÁKY A PROFILY

SERENA

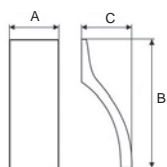

chrom satén



nikl broušený



BAREVNÉ PŘÍKRYTÍ	B	A	C	KÓD
chrom satén	70	20	20	365445
nikl broušený	70	20	20	365444

CATARINA

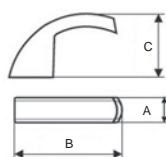

BAREVNÉ PŘÍKRYTÍ	B	A	C	KÓD
nikl broušený	34	8,5	20,6	365354

STELA

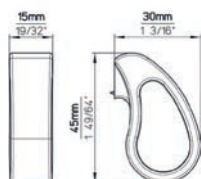

černá matná



mosaz ručně broušená nikl jemně broušený železo broušené



BAREVNÉ PŘÍKRYTÍ	B	A	C	KÓD
černá matná	45	15	30	859432
mosaz ručně broušená	45	15	30	859433
nikl jemně broušený	45	15	30	859434
železo broušené	45	15	30	859435

INESA

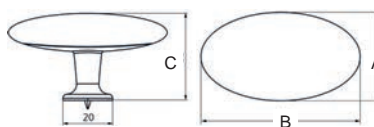

černá matná



antik ocel efekt antracit lesklý rez efekt ušlechtilá ocel mat železo černé patina

BAREVNÉ PŘÍKRYTÍ	B	A	C	KÓD
antik ocel efekt	64	36	35	012009
antracit lesklý	64	36	35	750143
černá matná	64	36	35	787856
rez efekt	64	36	35	709278
ušlechtilá ocel mat	64	36	35	661931
železo černé patina	64	36	35	787857

LIMA



železo broušené



antracit lesklý nikl jemně broušený



BAREVNÉ PŘÍKRYTÍ	ROZTEČ	B	A	C	KÓD
antracit lesklý	16	56	20	28	787858
nikl jemně broušený	16	56	20	28	785943
železo broušené	16	56	20	28	751881



→ LIMA, nikl jemně broušený

7.3 KNOPKY

7 ÚCHYTKY, VĚŠÁKY A PROFILY

ISSA

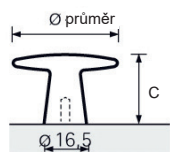

černá matná



chrom lesk nerez kartáčovaný

BAREVNÉ PŘÍKRYTÍ	PRŮMĚR	C	KÓD
černá matná	40	27	808889
chrom lesk	40	27	666591
nerez kartáčovaný	40	27	160725

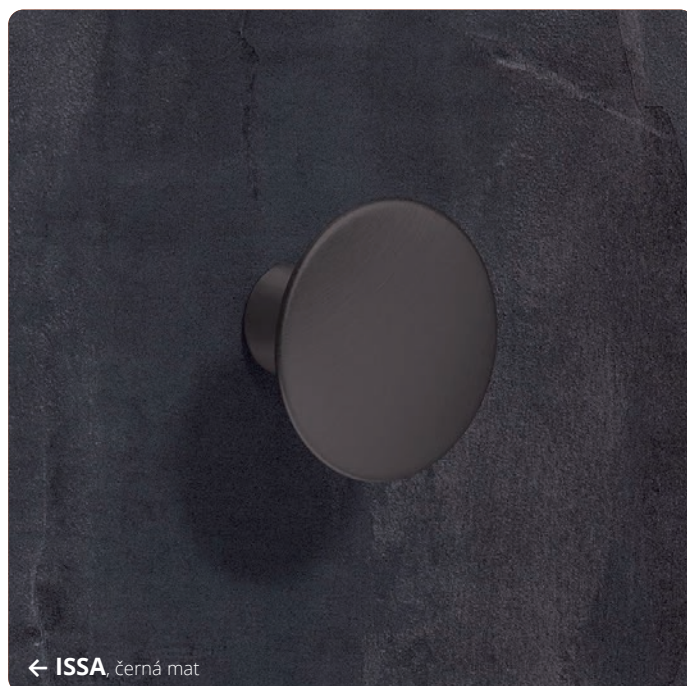

← ISSA, černá mat

VESNA

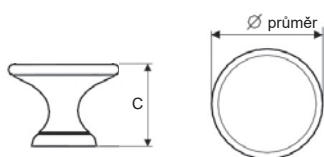

VESNA

BAREVNÉ PŘÍKRYTÍ	PRŮMĚR	C	KÓD
staromosaz kartáčovaná	30	24	360526

AGLIA

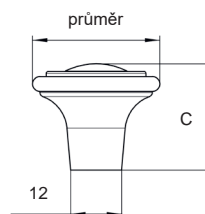

AGLIA

BAREVNÉ PŘÍKRYTÍ	PRŮMĚR	C	KÓD
staromosaz kartáčovaný	30	25	177644

ESSA

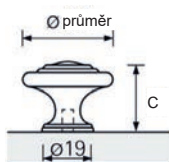

cínová



cínová antik měď antik mosazná antik

BAREVNÉ PŘÍKRYTÍ	PRŮMĚR	C	KÓD
cínová	32	25	350949
cínová antik	32	25	350947
měděná antik	32	25	350950
mosazná antik	32	25	350948

LAURA

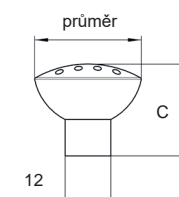

chrom lesklý



chrom satén



LAURA

BAREVNÉ PŘÍKRYTÍ	PRŮMĚR	C	KÓD
chrom lesklý	28	24	011667
chrom satén	28	24	011631

7.3 KNOPKY

7 ÚCHYTKY, VĚŠÁKY A PROFILY

MARILIN

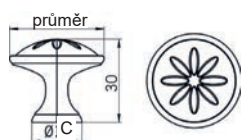

zinek /
plast bílý

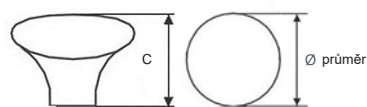

krémový porcelán
popraskaný



staromosaz /
plast béžový



MARILIN



bílý
porcelán

BAREVNÉ PŘÍMĚSÍ	PRŮMĚR	C	KÓD
staromosaz brnír/plast béžový	34	30	185948
zinek/plast bílý	34	30	515862

BAREVNÉ PŘÍMĚSÍ	PRŮMĚR	C	KÓD
bílý porcelán	32	23	365366
krémový porcelán popraskaný	32	23	365367

SIMON



nikl patina/
porcelán s
modrými lístky

staromosaz/
popraskaný
porcelán

nikl patina/
porcelán
s kvítkem

staromosaz/
porcelán
s lístky

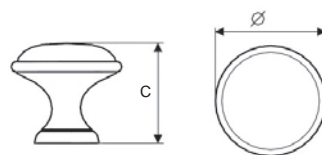

nikl patina /
bílý porcelán

BAREVNÉ PŘÍMĚSÍ	PRŮMĚR	C	KÓD
porcelán bílý	29	24	861539
porcelán bílý s modrými lístky	29	24	861544
porcelán popraskaný	29	24	861542
porcelán s kvítkem	29	24	861540
porcelán s lístky	29	24	861541
porcelán bílý	29	24	861545
porcelán bílý s modrými kvítky	29	24	861548
porcelán popraskaný	29	24	365356
porcelán s kvítkem	29	24	861546
porcelán s lístky	29	24	861547



GRETA

ADINA

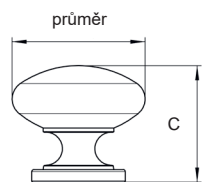

cín pálený

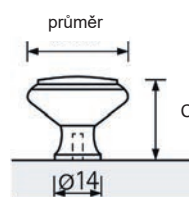

mosaz antik



černá
matná

staromosaz



ADINA



mosaz
lesk

BAREVNÉ PŘÍMĚSÍ	PRŮMĚR	C	KÓD
černá	33	27	805182
staromosaz	33	27	032618
starostříbrná	33	27	163944

BAREVNÉ PŘÍMĚSÍ	PRŮMĚR	C	KÓD
mosaz antik	30	23	351022
mosaz lesk	30	23	160652

7.3 KNOPKY

7 ÚCHYTKY, VĚŠÁKY A PROFILY

CLEO GRANDE

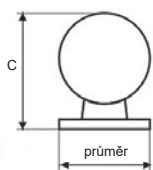

nikl satén



chrom lesklý

chrom satén

BAREVNÉ PROVEDENÍ	PRŮMĚR	C	KÓD
chrom lesklý	25	32	047281
chrom satén	25	32	057039
nikl satén	25	32	047282

CLEO PICCOLO

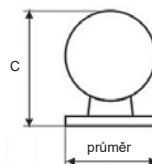

chrom lesklý



chrom satén

nikl satén

BAREVNÉ PROVEDENÍ	PRŮMĚR	C	KÓD
chrom lesklý	22	28	034698
chrom satén	22	28	103314
nikl satén	22	28	039627

LENNY

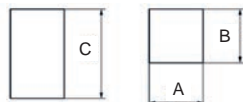

LENNY

BAREVNÉ PROVEDENÍ	B	A	C	KÓD
přirodní elox	15	15	25	710493

VIANA

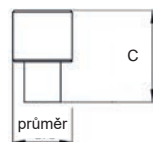

ušlechtilá ocel matná



černá matná starozlatá



VIANA

BAREVNÉ PROVEDENÍ	PRŮMĚR	C	KÓD
černá matná	16	25	784090
starozlatá	16	25	821477
ušlechtilá ocel matná	16	25	787862

ELLIEN

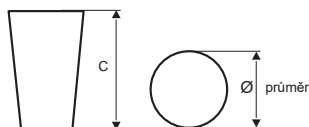

BAREVNÉ PROVEDENÍ	PRŮMĚR	C	KÓD
přirodní elox	20	25	512702

ONEX

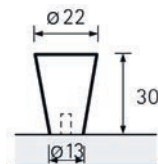

BAREVNÉ PROVEDENÍ	PRŮMĚR	C	KÓD
nerez kartáčovaný	22	30	351052

7.3 KNOPKY

7 ÚCHYTKY, VĚŠÁKY A PROFILY

ALMUS

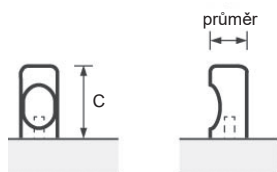

měď lesklá

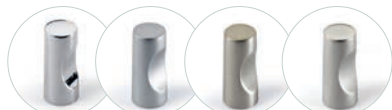

chrom lesklý

chrom matný

nerez kartáčovaný

nikl satén

BAREVNÉ PŘÍKRYTÍ	PRŮMĚR	C	KÓD
chrom lesklý	12	23	350901
chrom matný	12	23	350903
měď lesklá	12	23	664633
nerez kartáčovaný	12	23	350900
nikl satén	12	23	350902

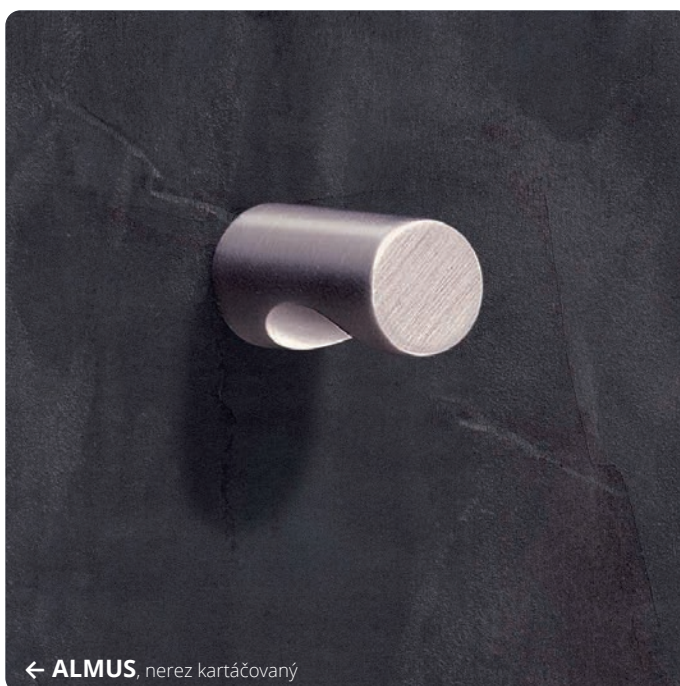

← ALMUS nerez kartáčovaný

KELLI

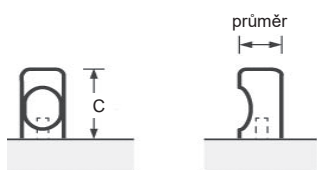

BAREVNÉ PŘÍKRYTÍ	PRŮMĚR	C	KÓD
nerez broušený	18	25	512703

MONACUM

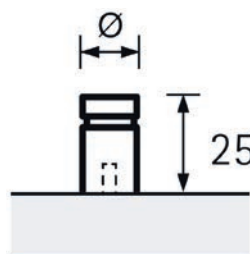

BAREVNÉ PŘÍKRYTÍ	PRŮMĚR	C	KÓD
nerez broušený	14	25	032518
	10	25	032519

7.4 DŘEVĚNÉ ÚCHYTKY

DRIVA

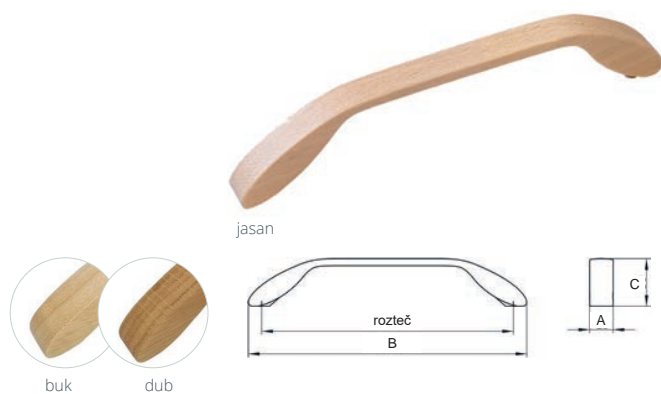

BAREVNÉ PROVEDENÍ	ROZTEČ	B	A	C	KÓD
buk	160	177	15	30	754604
dub	160	177	15	30	754603
jasan	160	177	15	30	754605



ARVIKA

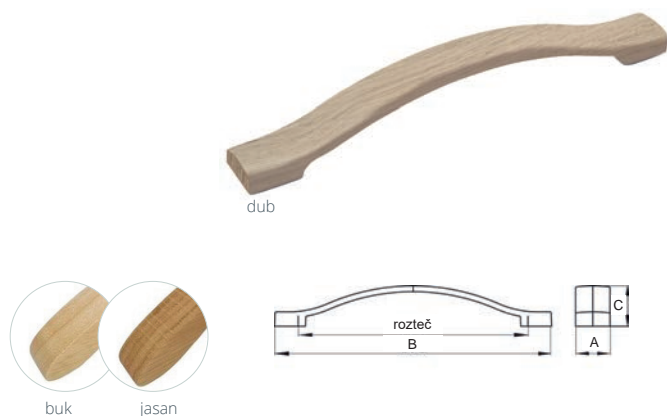

BAREVNÉ PROVEDENÍ	ROZTEČ	B	A	C	KÓD
buk	160	193	24	28	754601
dub	160	193	24	28	754600
jasan	160	193	24	28	754602

MUŠLE

> zádlab d x š x h: 100 x 40 x 13,5 mm

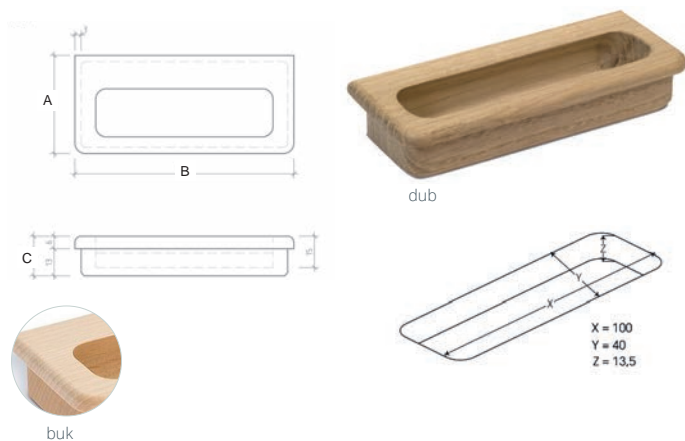

BAREVNÉ PROVEDENÍ	B	A	C	KÓD
buk	105	47	19	011904
dub	105	47	19	011914

VALERIO

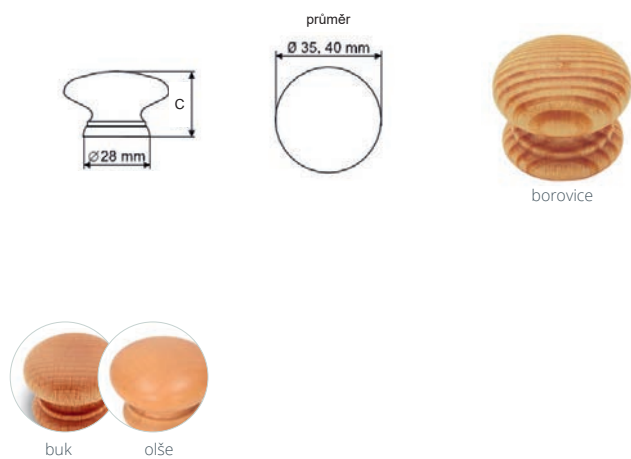

BAREVNÉ PROVEDENÍ	PRŮMĚR	C	KÓD
borovice	35	27	365369
buk	35	27	365368
olše	35	27	365370

7.5 KOŽENÉ A JINÉ ÚCHYTKY

7 ÚCHYTKY, VĚŠÁKY A PROFILY

7.5 KOŽENÉ A JINÉ ÚCHYTKY

DALAS

imitace kůže černá

imitace kůže hnědá

imitace kůže černá

BAREVNÉ PŘÍKRYTÍ	ROZTEČ	B	A	C	KÓD
imitace kůže černá	160	188	28	23	787864
imitace kůže hnědá	160	188	28	23	787865

BAREVNÉ PŘÍKRYTÍ	B	A	C	KÓD
imitace kůže černá	74	28	23	787854
imitace kůže hnědá	74	28	23	787855

TEXAS

imitace kůže béžová

imitace kůže hnědá

imitace kůže černá

imitace kůže béžová

imitace kůže černá

BAREVNÉ PŘÍKRYTÍ	ROZTEČ	B	A	C	KÓD
imitace kůže béžová	160	188	28	23	787888
imitace kůže černá	160	188	28	23	787889
imitace kůže hnědá	160	188	28	23	787890

BAREVNÉ PŘÍKRYTÍ	B	A	C	KÓD
imitace kůže béžová	70	28	23	787859
imitace kůže černá	70	28	23	787860
imitace kůže hnědá	70	28	23	787861

SANTIAGO

NAŠ TIP

Úchytka i knopka SANTIAGO má kovové vložky pro šrouby.

BAREVNÉ PŘÍKRYTÍ	ROZTEČ	B	A	C	KÓD
provazová úchytka plastová s flexibilní roztečí	optimálně 64	101	37	50	793135
	optimálně 128	165	37	50	721488
	optimálně 192	229	37	60	820130

BAREVNÉ PŘÍKRYTÍ	PRŮMĚR	C	KÓD
provazová knopka plastová	37	64	754607

7.6 PLASTOVÉ A DĚTSKÉ ÚCHYTKY, KNOPKY A VĚŠÁKY

7 ÚCHYTKY, VĚŠÁKY A PROFILY

7.6 PLASTOVÉ A DĚTSKÉ ÚCHYTKY, KNOPKY A VĚŠÁKY

BOLTA

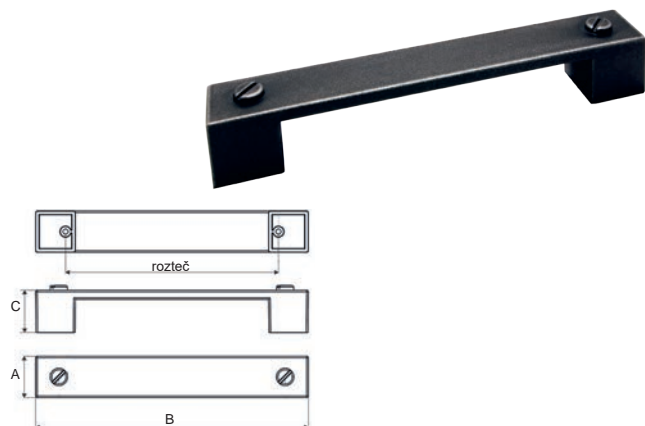

BAREVNÉ PŘÍKRYTÍ	ROZTEČ	B	A	C	KÓD
stříbro antik	128	164	25	25	787516



ELI



BAREVNÉ PŘÍKRYTÍ	ROZTEČ	B	A	C	KÓD
bílá matná	128	140	15	30	861431
bílá matná - soft touch	160	172	15	30	861435
	320	332	15	28	861439
černá matná - soft touch	128	140	15	30	850127
	160	172	15	30	850128
	320	332	15	28	850129
starorůžová matná - soft touch	128	140	15	30	861430
	160	172	15	30	861434
	320	332	15	28	861438
tmavě modrá matná - soft touch	128	140	15	30	861428
	160	172	15	30	861432
	320	332	15	28	861436
žlutá matná - soft touch	128	140	15	30	861429
	160	172	15	30	861433
	320	332	15	28	861437

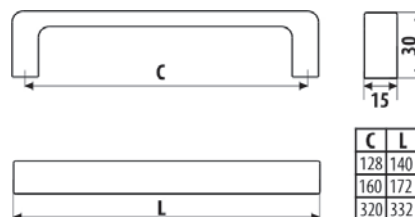

HONEY



BAREVNÉ PŘÍKRYTÍ	ROZTEČ	B	A	C	KÓD
bílá matná	128	136	14	30	861459
bílá matná - soft touch	160	168	14	30	861464
	320	328	14	30	861469
černá matná - soft touch	128	136	14	30	861458
	160	168	14	30	861463
	320	328	14	30	861468
starorůžová matná - soft touch	128	136	14	30	861457
	160	168	14	30	861462
	320	328	14	30	861467
tmavě modrá matná - soft touch	128	136	14	30	861455
	160	168	14	30	861460
	320	328	14	30	861465
žlutá matná - soft touch	128	136	14	30	861456
	160	168	14	30	861461
	320	328	14	30	861466

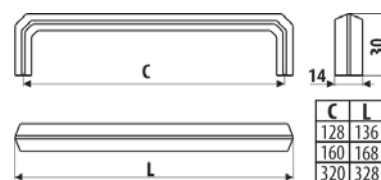

7.6 PLASTOVÉ A DĚTSKÉ ÚCHYTKY, KNOPKY A VĚŠÁKY

7 ÚCHYTKY, VĚŠÁKY A PROFILY

RUBI



bílá matná černá matná starorůžová matná tmavě modrá matná

BAREVNÉ PŘÍKRYTÍ	ROZTEČ	B	A	C	KÓD
bílá matná - soft touch	128	138	25	28	861444
	160	170	25	28	861449
	320	330	25	28	861454
černá matná - soft touch	128	138	25	28	861443
	160	170	25	28	861448
	320	330	25	28	861453
starorůžová matná - soft touch	128	138	25	28	861442
	160	170	25	28	861447
	320	330	25	28	861452
tmavě modrá matná - soft touch	128	138	25	28	861440
	160	170	25	28	861445
	320	330	25	28	861450
žlutá matná - soft touch	128	138	25	28	861441
	160	170	25	28	861446
	320	330	25	28	861451



žlutá matná

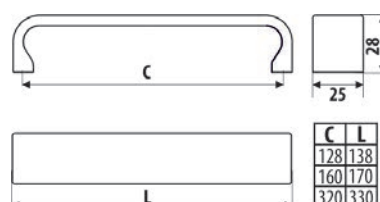

LUPO

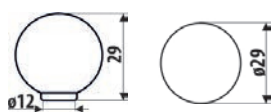

oranžová

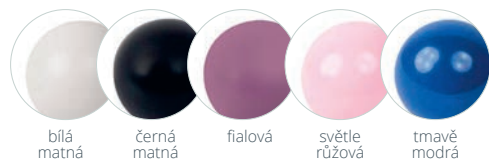

bílá matná černá matná fialová světle růžová tmavě modrá

BAREVNÉ PŘÍKRYTÍ	PRŮMĚR	C	KÓD
bílá matná	29	29	861472
černá matná	29	29	861471
fialová	29	29	861475
oranžová	29	29	861470
světle růžová	29	29	861474
tmavě modrá	29	29	861473

KNOFLÍK

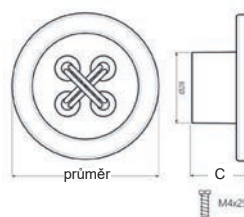

růžová



bílá modrá

BAREVNÉ PŘÍKRYTÍ	PRŮMĚR	C	KÓD
bílá	58	23	754606
modrá	58	23	751253
růžová	58	23	721063

HVĚZDIČKA

> věšák

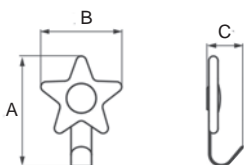

žlutá



modrá růžová

BAREVNÉ PŘÍKRYTÍ	A	B	C	KÓD
modrá	97	71	30	692825
růžová	97	71	30	692824
žlutá	97	71	30	692823

KYTIČKA

> věšák

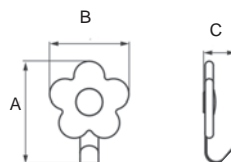

růžová



žlutá

BAREVNÉ PŘÍKRYTÍ	A	B	C	KÓD
růžová	100	77	30	692822
žlutá	100	77	30	692225

7.7 ZÁPUSTNÉ ÚCHYTKY

ADRIANA

> zádlab d x š x h: 107 x 31 x 12,5 mm

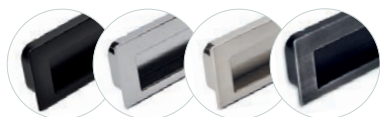

černá matná chrom lesklý nikl jemně broušený železo broušené

BAREVNÉ PROVEDENÍ	ROZTEČ	B	A	C	KÓD
černá matná	96	112	38	16	753996
chrom lesklý	96	112	38	16	787907
mosaz ručně broušený	96	112	38	16	750435
nikl jemně broušený	96	112	38	16	763765
železo broušené	96	112	38	16	751887



mosaz ručně broušený

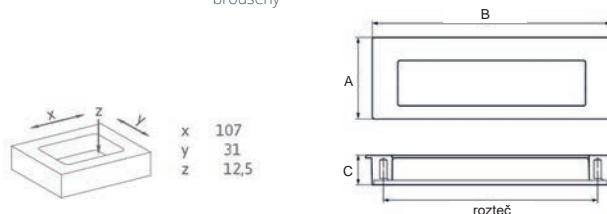

MONICA II



nikl satén / imitace nerezí



hliník / chrom satén

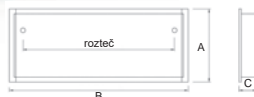

BAREVNÉ PROVEDENÍ	ROZTEČ	B	A	C	KÓD
hliník/chrom	128	141	43	16	344292
	160	173	43	16	344294
	224	237	43	16	344296
	320	333	43	16	413934
matný chrom/hliník	128	141	43	16	391030
	160	173	43	16	411568
nikl satén/imitace nerezí	128	141	43	16	344293
	160	173	43	16	344295
	224	237	43	16	344297
	320	333	43	16	413935

NIDUM

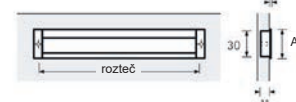
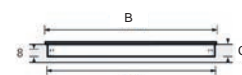

BAREVNÉ PROVEDENÍ	ROZTEČ	B	A	C	KÓD
elox-alu finiš	96	111	35	11	029808
	128	143	35	11	029809
	160	175	35	11	036056
	192	207	35	11	043448
	256	271	35	11	042671
320	335	35	11	037603	

MISNIA



hliník



nikl satén

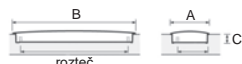

BAREVNÉ PROVEDENÍ	ROZTEČ	B	A	C	KÓD
hliník	96	116	54	14,5	036042
	160	180	54	14,5	161109
	96	116	54	14,5	037246
nikl satén	160	180	54	14,5	031099

VIKTORIE



chrom satén

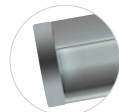

chrom satén

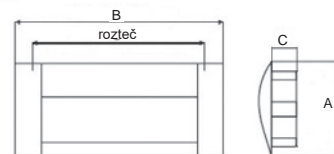

BAREVNÉ PROVEDENÍ	ROZTEČ	B	A	C	KÓD
chrom	96	110	45	12	031968
	128	142	45	12	122159
	160	174	45	12	581272
chrom satén	96	110	45	12	063592
	128	142	45	12	031967
	160	174	45	12	792693

7.7 ZÁPUSTNÉ ÚCHYTKY

7 ÚCHYTKY, VĚŠÁKY A PROFILY

INNA

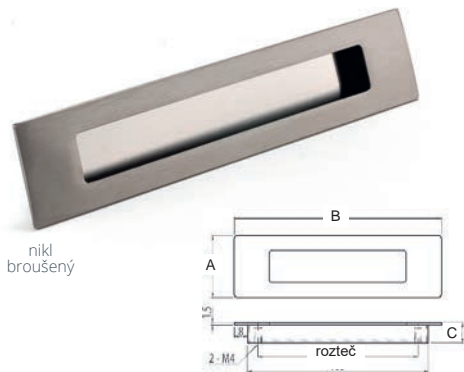

nikl broušený



chrom

BAREVNÉ PŘÍKRYTÍ	ROZTEČ	B	A	C	KÓD
chrom	96	124	37,5	12,3	569794
	160	186	37,5	12,3	569796
nikl broušený	96	124	37,5	12,3	569795
	160	186	37,5	12,3	569797

ENRICO

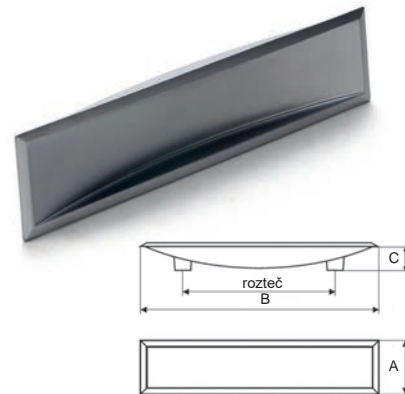

BAREVNÉ PŘÍKRYTÍ	ROZTEČ	B	A	C	KÓD
chrom satén	128	150	34	10	142728

ATHENA

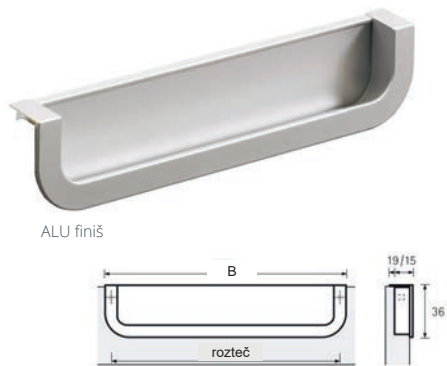

ALU finiš



chrom lesklý

nerez finiš

BAREVNÉ PŘÍKRYTÍ	ROZTEČ	B	A	C	KÓD
alu finiš	160	170	33	15	161098
chrom lesklý	160	170	33	15	161127
nerez finiš	160	170	33	15	161214

IVANA

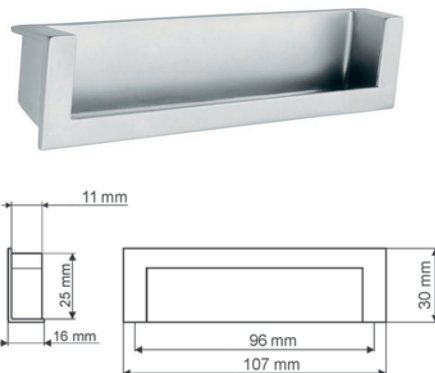

BAREVNÉ PŘÍKRYTÍ	ROZTEČ	B	A	C	KÓD
chrom satén	96	107	30	25	205507

NIKOLETA



černá matná



nikl broušený / černá

nikl broušený / bílá

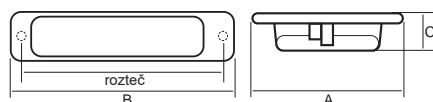

BAREVNÉ PŘÍKRYTÍ	ROZTEČ	B	A	C	KÓD
černá matná	160	173	45	18	825690
černá matná	224	237	45	18	825691
	320	377	45	18	825692
	160	173	45	18	825696
nikl broušený/bílá	224	237	45	18	825697
	320	377	45	18	825698
	160	173	45	18	825693
nikl broušený/černá	224	237	45	18	825694
	320	377	45	18	825695

MAJA

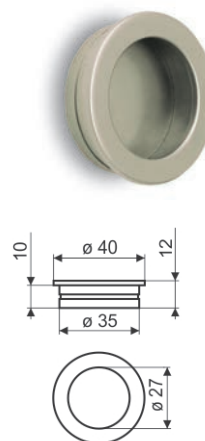

chrom satén

BAREVNÉ PŘÍKRYTÍ	PRŮMĚR	C	KÓD
nikl satén	40	22	039374
chrom satén	40	22	295622

7.8 VĚŠÁKY

7 ÚCHYTKY, VĚŠÁKY A PROFILY

7.8 VĚŠÁKY

KANSAS

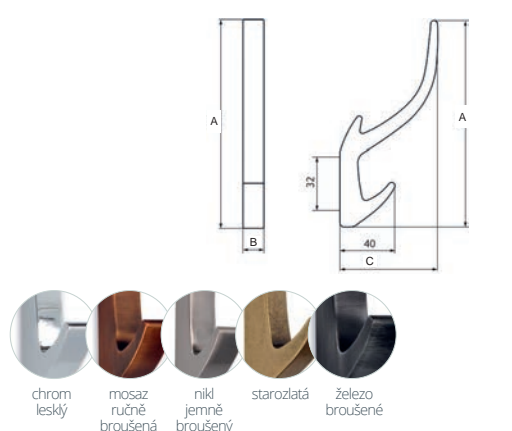

BAREVNÉ PŘÍMĚŠKY	B	A	C	KÓD
černá matná	15	150	71	786678
chrom lesklý	15	150	71	754608
mosaz ručně broušená	15	150	71	750434
nikl jemně broušený	15	150	71	754609
starozlatá	15	150	71	787910
železo broušené	15	150	71	751892



černá matná



BAREVNÉ PŘÍMĚŠKY	B	A	C	KÓD
černá matná	15	81	40	786680
chrom lesklý	15	81	40	754610
mosaz ručně broušená	15	81	40	754612
nikl jemně broušený	15	81	40	751065
starozlatá	15	81	40	787909
železo broušené	15	81	40	754611



mosaz ručně broušená

7

TOMAS

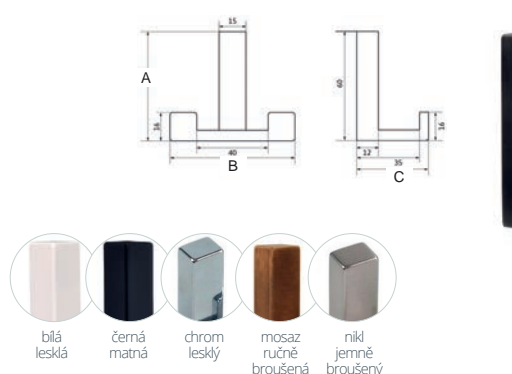

BAREVNÉ PŘÍMĚŠKY	B	A	C	KÓD
bílá lesklá	70	60	40	742426
černá matná	70	60	40	753279
chrom lesklý	70	60	40	642105
mosaz ručně broušená	70	60	40	873841
nikl jemně broušený	70	60	40	559840
železo broušené	70	60	40	718926



železo broušené

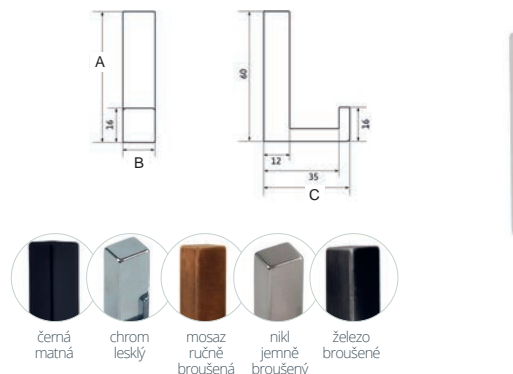

BAREVNÉ PŘÍMĚŠKY	B	A	C	KÓD
bílá lesklá	15	60	40	787911
černá matná	15	60	40	740137
chrom lesklý	15	60	40	633279
mosaz ručně broušená	15	60	40	873837
nikl jemně broušený	15	60	40	570824
železo broušené	15	60	40	752349



bílá lesklá



↑ TOMAS, černá matná, bílá lesklá

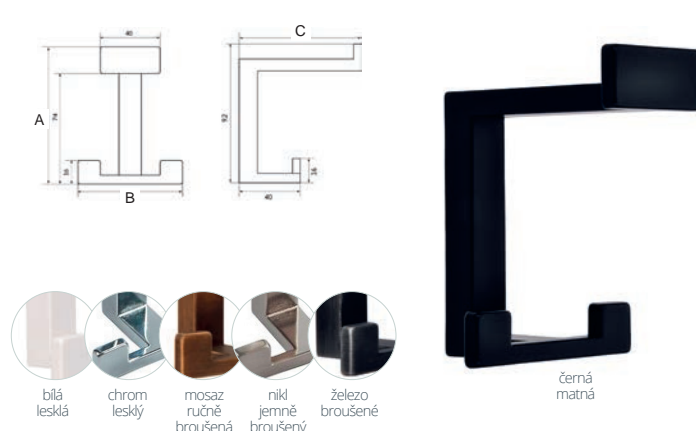

BAREVNÉ PŘÍMĚŠKY	B	A	C	KÓD
bílá lesklá	70	92	80	771030
černá matná	70	92	80	738080
chrom lesklý	70	92	80	572007
mosaz ručně broušená	70	92	80	835793
nikl jemně broušený	70	92	80	559814
železo broušené	70	92	80	711533



černá matná

7.8 VĚŠÁKY

7 ÚCHYTKY, VĚŠÁKY A PROFILY

AYA

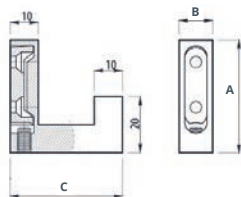

nikl broušený chrom



černá matná

BAREVNÉ PŘÍKLEBY	B	A	C	KÓD
černá matná	12	40	40	885707
chrom	12	40	40	512049
nikl broušený	12	40	40	512050

CORA

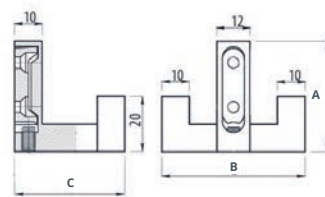

chrom černá matná



nikl broušený

BAREVNÉ PŘÍKLEBY	B	A	C	KÓD
černá matná	52	40	40	885708
chrom	52	40	40	512051
nikl broušený	52	40	40	512052

FLINT

> zádlab d x š x h: 174 x 10 x 13 mm

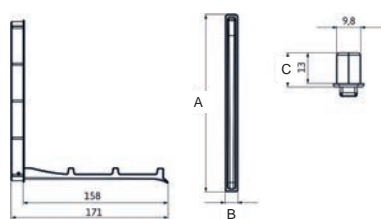

nikl jemně broušený



chrom lesklý

BAREVNÉ PŘÍKLEBY	B	A	C	KÓD
chrom lesklý	13	177	14,5	664311
nikl jemně broušený	13	177	14,5	683318

> zádlab d x š x h: 90 x 10 x 13 mm

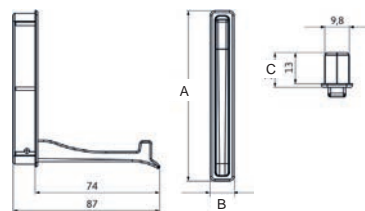

chrom lesklý nikl jemně broušený



černá matná

BAREVNÉ PŘÍKLEBY	B	A	C	KÓD
černá matná	13	93	14,5	787908
chrom lesklý	13	93	14,5	681577
nikl jemně broušený	13	93	14,5	683131

VALENCIO

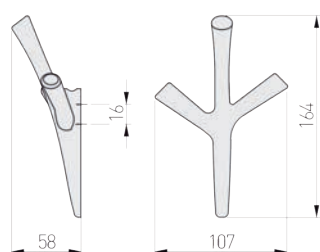

chrom lesklý nerez broušený



černá matná

BAREVNÉ PŘÍKLEBY	B	A	C	KÓD
černá matná	128	140	29	885706
chrom lesklý	128	140	29	885704
nerez broušený	128	140	29	885705



← VALENCIO

7.8 VĚŠÁKY

7 ÚCHYTKY, VĚŠÁKY A PROFILY

DENVER

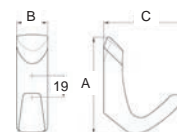
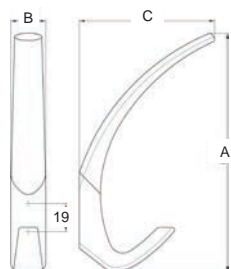

BAREVNÉ PROVEDENÍ	B	A	C	KÓD
hliník/chrom lesk	24	160	90	802072

BAREVNÉ PROVEDENÍ	B	A	C	KÓD
hliník/chrom lesk	24	73	64	802073

TOLEDO

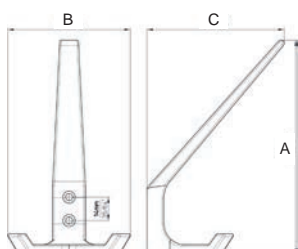

BAREVNÉ PROVEDENÍ	B	A	C	KÓD
hliník lesklý	76	130	57	215815

BAREVNÉ PROVEDENÍ	B	A	C	KÓD
hliník lesklý	78	43	82,5	345154

FABIO

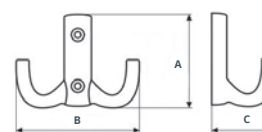
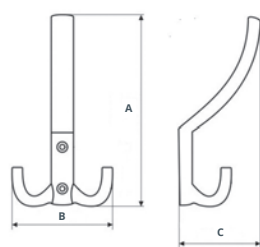

BAREVNÉ PROVEDENÍ	B	A	C	KÓD
černá matná	78	144	60	850799
chrom	78	144	60	063669
chrom satén	78	144	60	063671
nikl broušený	78	144	60	794993
nikl satén	78	144	60	063670



BAREVNÉ PROVEDENÍ	B	A	C	KÓD
černá matná	78	58	30	850797
chrom	78	58	30	063665
chrom satén	78	58	30	063667
nikl broušený	78	58	30	794994
nikl satén	78	58	30	063666

7.8 VĚŠÁKY

7 ÚCHYTKY, VĚŠÁKY A PROFILY

MARCO

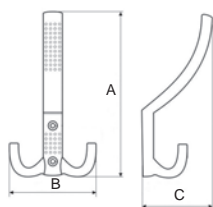

nikl satén

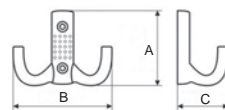

černá matná chrom lesklý nikl satén



chrom satén



černá matná chrom lesklý chrom satén

BAREVNÉ PŘÍKRYTÍ	B	A	C	KÓD
černá matná	78	144	60	850801
chrom lesklý	78	144	60	063645
chrom satén	78	144	60	063647
nikl satén	78	144	60	063646

BAREVNÉ PŘÍKRYTÍ	B	A	C	KÓD
černá matná	78	58	30	850800
chrom lesklý	78	58	30	063655
chrom satén	78	58	30	063663
nikl satén	78	58	30	063656

TEXON

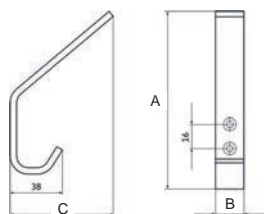

černá matná

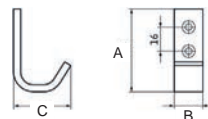

bílá lesklá



černá matná

BAREVNÉ PŘÍKRYTÍ	B	A	C	KÓD
bílá lesklá	19	120	75	794342
černá matná	19	120	75	724055

BAREVNÉ PŘÍKRYTÍ	B	A	C	KÓD
bílá lesklá	19	55	38	794357
černá matná	19	55	38	739039

KUBO

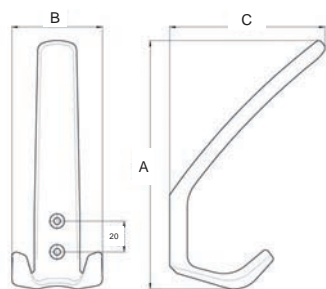

černá

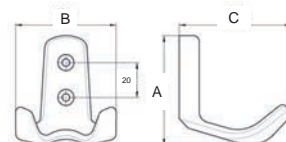

hnědá nikl tmavě hnědá



černá nikl tmavě hnědá



hnědá

BAREVNÉ PŘÍKRYTÍ	B	A	C	KÓD
černá (plast)	57	150	96	823009
hnědá (plast)	57	150	96	823010
nikl (plast)	57	150	96	823012
tmavě hnědá (plast)	57	150	96	823011

BAREVNÉ PŘÍKRYTÍ	B	A	C	KÓD
černá (plast)	57	62	62	823013
hnědá (plast)	57	62	62	823014
nikl (plast)	57	62	62	823016
tmavě hnědá (plast)	57	62	62	823015

7.8 VĚŠÁKY

7 ÚCHYTKY, VĚŠÁKY A PROFILY

LINA

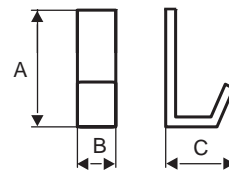
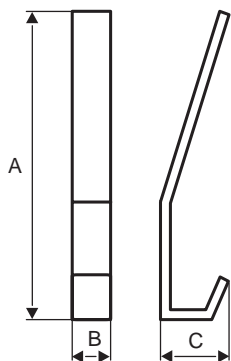

BAREVNÉ PROVEDENÍ	B	A	C	KÓD
nerez broušený	20	142	65	512705

BAREVNÉ PROVEDENÍ	B	A	C	KÓD
nerez broušený	20	60	45	512706

PIETRO

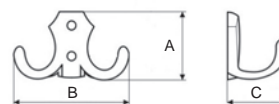
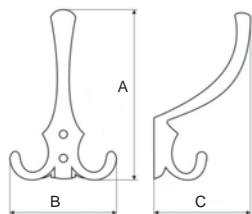

BAREVNÉ PROVEDENÍ	B	A	C	KÓD
černá matná	78	125	70	850803
chrom	78	125	70	012099
chrom satén	78	125	70	063674
nikl satén	78	125	70	012026
staromosaz	78	125	70	012027

BAREVNÉ PROVEDENÍ	B	A	C	KÓD
černá matná	78	46	30	850802
chrom	78	46	30	012022
chrom satén	78	46	30	063675
nikl satén	78	46	30	012023
staromosaz	78	46	30	012024

PEDRO

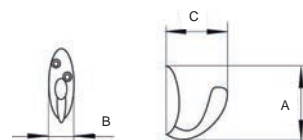
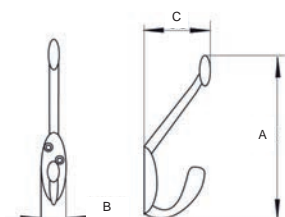

BAREVNÉ PROVEDENÍ	B	A	C	KÓD
černá matná	17,5	88	56	860122
chrom lesklý	17,5	88	56	754613
nikl matný	17,5	88	56	497260

BAREVNÉ PROVEDENÍ	B	A	C	KÓD
černá matná	18	43	38	860123
chrom lesklý	18	43	38	121266
nikl matný	18	43	38	417787

7.8 VĚŠÁKY

7 ÚCHYTKY, VĚŠÁKY A PROFILY

ISIS

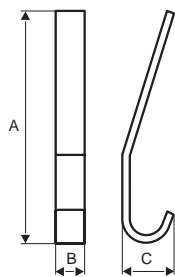

BAREVNÉ PŘÍRODNÍ	B	A	C	KÓD
přírodní elox	18	175	50	512707

PAOLO

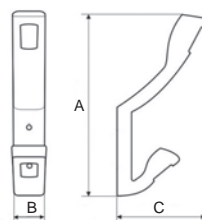

chrom chrom satén nikl satén

nikl broušený

BAREVNÉ PŘÍRODNÍ	B	A	C	KÓD
chrom	23	152	70	346320
chrom satén	23	152	70	135027
nikl broušený	23	152	70	459293
nikl satén	23	152	70	042493

SOTERA

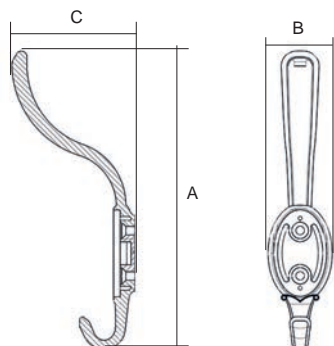

BAREVNÉ PŘÍRODNÍ	B	A	C	KÓD
staromosaz / plast béžový	34	158	66	411140

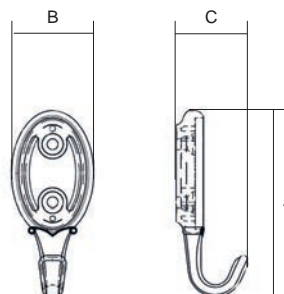

BAREVNÉ PŘÍRODNÍ	B	A	C	KÓD
staromosaz / plast béžový	34	77	29	569818

POLO

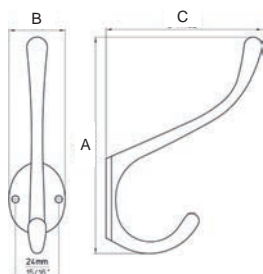

bílá lesklá černá matná

BAREVNÉ PŘÍRODNÍ	ROZTEČ	B	A	C	KÓD
bílá lesklá	24	33	120	86	787933
černá matná	24	33	120	86	787934
hliník leštěný	24	33	120	86	787935

ANTONIO

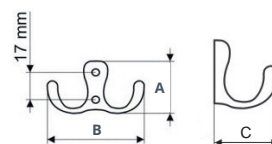

chrom chrom satén mosaz nikl satén



černá matná

BAREVNÉ PŘÍRODNÍ	B	A	C	KÓD
černá	56	30	30	660661
chrom	56	30	30	012068
chrom satén	56	30	30	012070
mosaz	56	30	30	029027
nikl satén	56	30	30	012077

7.8 VĚŠÁKY

7 ÚCHYTKY, VĚŠÁKY A PROFILY

SPARTA II

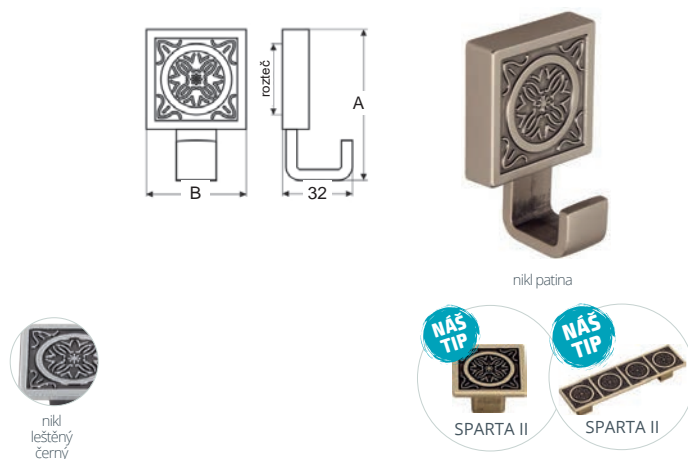

BAREVNÉ PROVEDENÍ	ROZTEČ	B	A	C	KÓD
nikl leštěný černý	32	45	68	32	861569
nikl patina	32	45	68	32	861567

NIA

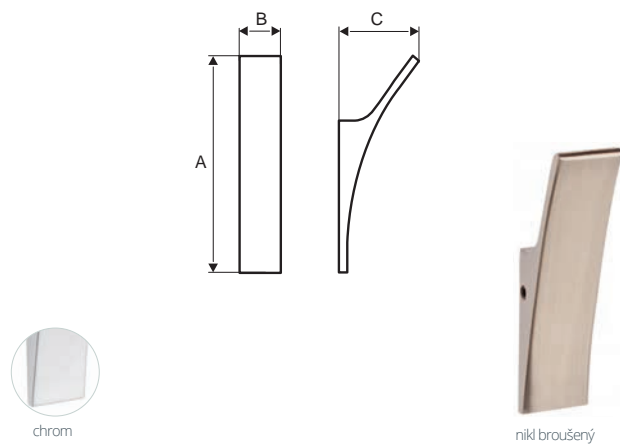

BAREVNÉ PROVEDENÍ	B	A	C	KÓD
chrom	19	72	24	512053
nikl broušený	19	72	24	512054

ALTIS

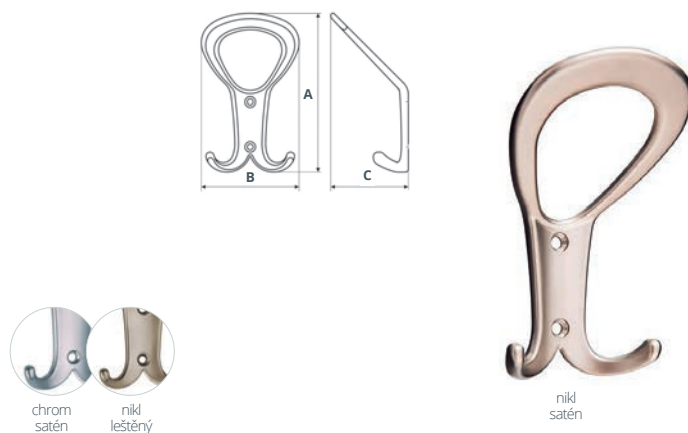

BAREVNÉ PROVEDENÍ	B	A	C	KÓD
chrom satén	70	113	55	492966
nikl leštěný	70	113	55	492961
nikl satén	70	113	55	492962

NAVY

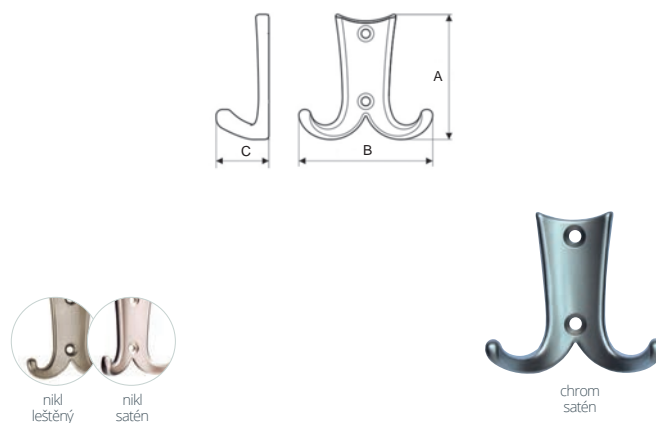

BAREVNÉ PROVEDENÍ	B	A	C	KÓD
chrom satén	63	59	25	492958
nikl leštěný	63	59	25	492959
nikl satén	63	59	25	492960

VIANA

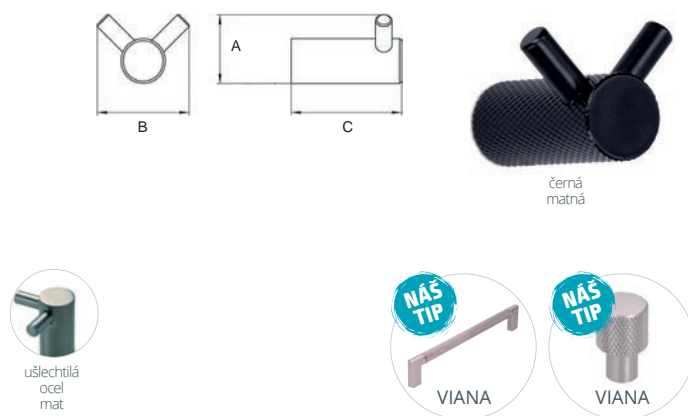

BAREVNÉ PROVEDENÍ		B	A	C	KÓD
černá matná	dvojitý	26	34	40	787912
	jednoduchý	30	16	40	855661
ušlechtilá ocel mat	dvojitý	26	34	40	787913

7.9 PROFILOVÉ ÚCHYTKY

LAMEZIA

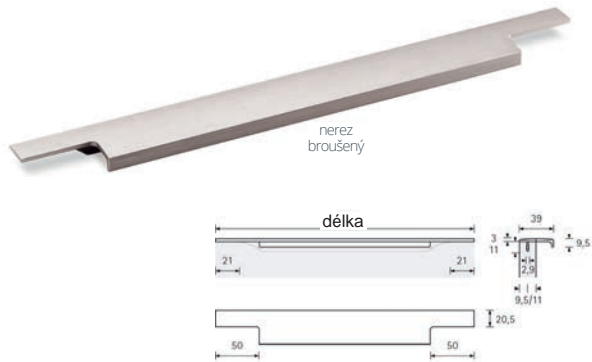

BAREVNÉ PŘÍMĚŠENÍ	DĚLKA	KÓD
černá matná	295	808892
	345	808894
	395	808896
	445	808898
	495	808900
	595	808902
	795	808904
	895	808906
	995	808908
	1195	808890
hliník	295	317350
	345	317351
	395	317352
	445	317353
	495	317354
	595	317355
	795	317356
	895	317357
	995	317358
	1195	317359
chrom lesklý	295	317360
	345	317361
	395	317362
	445	317363
	495	317364
	595	317365
	795	317366
	895	317367
	995	317368
	1195	317369
nerez broušený	295	317370
	345	317371
	395	317372
	445	317373
	495	317374
	595	317375
	795	317376
	895	317377
	995	317378
	1195	317379
zlatá kartáčovaná	295	808893
	345	808895
	395	808897
	495	808901
	595	808903
	795	808905

SIMIA

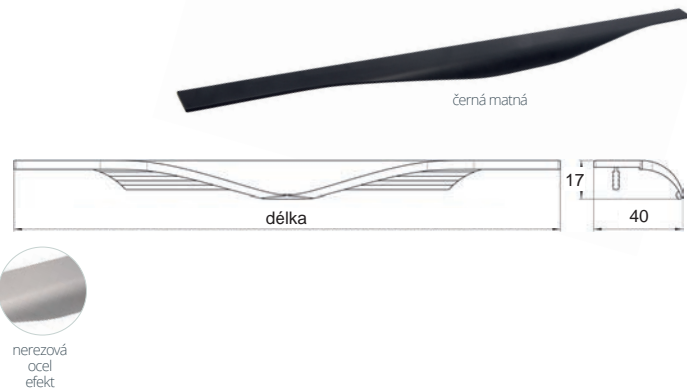

BAREVNÉ PŘÍMĚŠENÍ	DĚLKA	KÓD
černá matná	245	794933
	295	794935
	345	794937
	395	794939
	445	794941
	495	794943
	545	794945
	595	794947
	695	794949
	795	794951
nerezová ocel efekt	895	794953
	995	794955
	1 095	794957
	1 195	794959
	245	794932
	295	794934
	345	794936
	395	794938
	445	794940
	495	794942
545	794944	
595	794946	
695	794948	
795	794950	
895	794952	
995	794954	
1 095	794956	
1 195	794958	

THEA

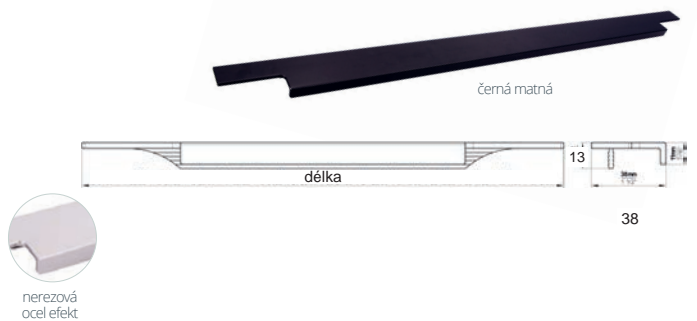

BAREVNÉ PŘÍMĚŠENÍ	DĚLKA	KÓD
černá matná	295	802158
	395	802159
	495	802160
	595	802162
	695	802129
	795	802163
	895	802165
	995	802167
	295	802157
	395	789917
nerezová ocel efekt	495	789918
	595	802161
	695	802128
	795	789920
	895	802164
	995	802166

PROFILOVÉ ÚCHYTKY

Profilové úchytky jsou velmi oblíbené pro svou čistou linii. Úchytky se montují **naražením do hrany dvířek** do předem vyfrézované drážky.

V naší nabídce naleznete již **hotové úchytky s přesným rozměrem v délkách od 196 do 1 196 mm a s odřezaným stromečkem** k naražení do dvířek, případně s odřezovaným úchytem s přesně definovaným rádiusem vybrání úchyty. **Profilové úchytky lze rovněž připravit na míru** v libovolné délce až 6 m.



lakování
RAL

Všechny profilové úchytky lze lakovat do libovolné barvy dle dostupného RAL vzorníku.



lakování
IGP

V rámci lakování nabízíme rovněž vysoce odolný povrch IGP v černé barvě. Tato barva vyniká stálostí barvy, odolností vůči UV záření a je rovněž otěru odolná.

UK 2

- > materiál hliník
- > barva hliník, černá matná



lakování
RAL



lakování
IGP

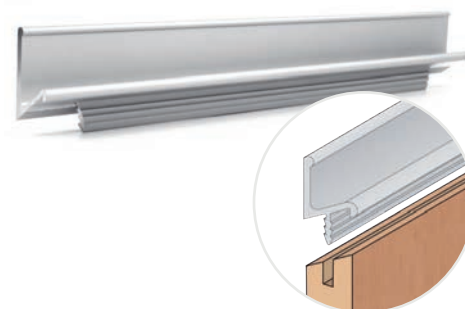
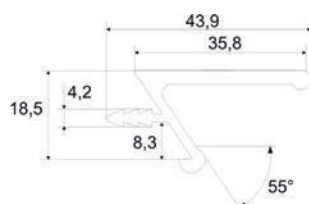

BARVA / DÉLKA (MM)	196	246	296	346	396	446	496	546	596	696	796	896	996	1 196
hliník	793648	793649	793650	793651	793652	793653	793654	793655	793656	793657	793658	793659	793660	793661
černá matná	793662	793663	793664	793665	793666	793667	793668	793669	793670	793671	793672	793673	793674	793675

UK 4

- > materiál hliník
- > barva hliník, černá matná



lakování
RAL



lakování
IGP

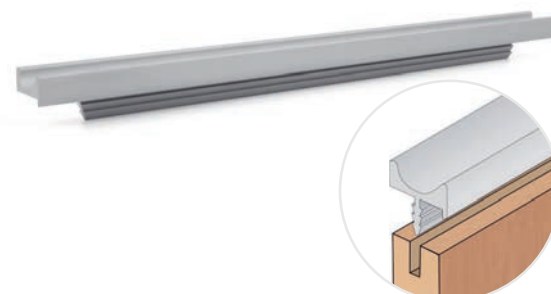
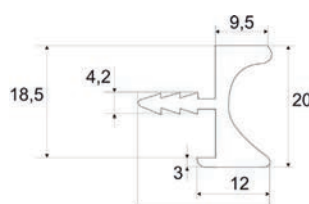

BARVA / DÉLKA (MM)	196	246	296	346	396	446	496	546	596	696	796	896	996	1 196
hliník	793676	793677	793678	793679	793680	793681	793682	793683	793684	793685	793686	793687	793688	793689
černá matná	793690	793691	793692	793693	793694	793695	793696	793697	793698	793699	793700	793701	793702	793703

UK 5

- > materiál hliník
- > barva hliník, nerez, černá matná



lakování
RAL



lakování
IGP

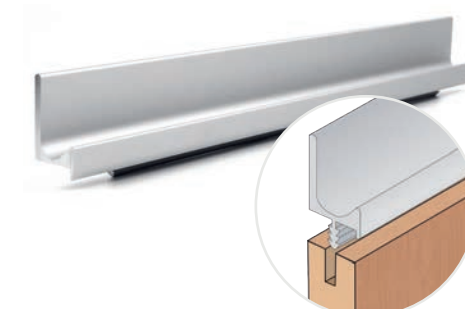
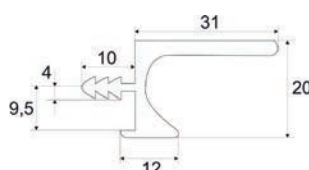

BARVA / DÉLKA (MM)	196	246	296	346	396	446	496	546	596	696	796	896	996	1 196
hliník	793704	793705	793706	793707	793708	793709	793710	793711	793712	793713	793714	793715	793716	793717
nerez	793718	793719	793720	793721	793722	793723	793724	793725	793726	793727	793728	793729	793730	793731
černá matná	793732	793733	793734	793735	793736	793737	793738	793739	793740	793741	793742	793743	793744	793745

UK 7

- > materiál hliník
- > barva hliník, nerez, nerez lakovaný, černá

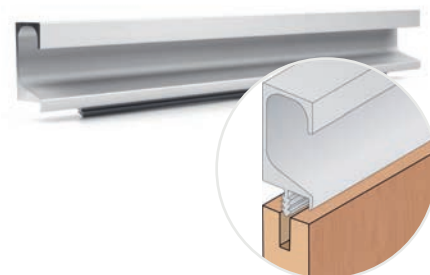
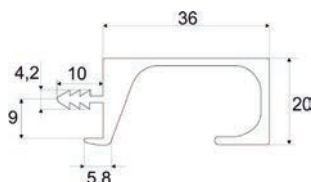
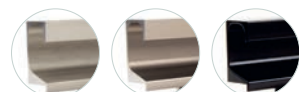

BARVA / DÉLKA (MM)	196	246	296	346	396	446	496	546	596	696	796	896	996	1 196
hliník	793774	793775	793776	793777	793778	793779	793780	793781	793782	793783	793784	793785	793786	793787
nerez	793788	793789	793790	793791	793792	793793	793794	793795	793796	793797	793798	793799	793800	793801
nerez lakovaný	793802	793803	793804	793805	793806	793807	793808	793809	793810	793811	793812	793813	793814	793815
černá	793816	793817	793818	793819	793820	793821	793822	793823	793824	793825	793826	793827	793828	793829

UK 8

- > materiál hliník
- > barva hliník, světlý nerez, tmavý nerez, chrom, černá

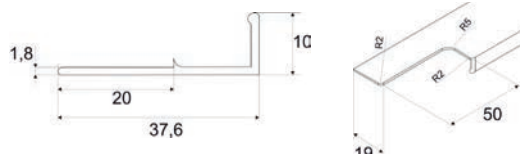

BARVA / DÉLKA (MM)	196	246	296	346	396	446	496	546	596	696	796	896	996	1 196
hliník	793830	793831	793832	793833	793834	793835	793836	793837	793838	793839	793840	793841	793842	793843
nerez světlý	793872	793873	793874	793875	793876	793877	793878	793879	793880	793881	793882	793883	793884	793885
nerez tmavý	793886	793887	793888	793889	793890	793891	793892	793893	793894	793895	793896	793897	793898	793899
chrom	793844	793845	793846	793847	793848	793849	793850	793851	793852	793853	793854	793855	793856	793857
černá	793858	793859	793860	793861	793862	793863	793864	793865	793866	793867	793868	793869	793870	793871

UK 8 N

- > materiál hliník
- > barva hliník, světlý nerez, tmavý nerez, chrom, černá

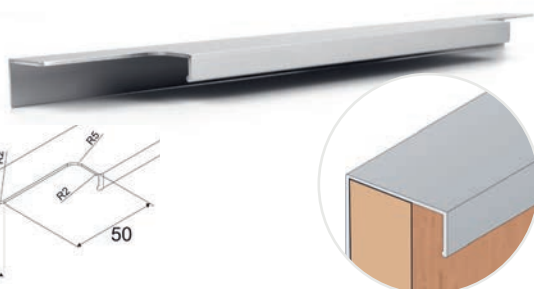
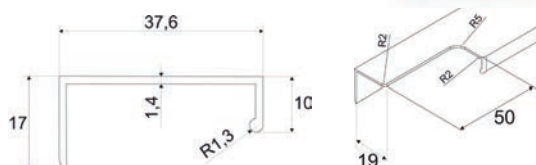

BARVA / DÉLKA (MM)	196	246	296	346	396	446	496	546	596	696	796	896	996	1 196
hliník	793900	793901	793902	793903	793904	793905	793906	793907	793908	793909	793910	793911	793912	793913
světlý nerez	793942	793943	793944	793945	793946	793947	793948	793949	793950	793951	793952	793953	793954	793955
tmavý nerez	793956	793957	793958	793959	793960	793961	793962	793963	793964	793965	793966	793967	793968	793969
chrom	793914	793915	793916	793917	793918	793919	793920	793921	793922	793923	793924	793925	793926	793927
černá	793928	793929	793930	793931	793932	793933	793934	793935	793936	793937	793938	793939	793940	793941



V případě, že potřebujete jiný rozměr profilové úchytky, obraťte se na naše obchodní oddělení. Vybrané druhy úchytek nabízíme také v provedení metráž, více informací na následující straně.

UK 9

- > materiál hliník
- > barva hliník, světlý nerez, tmavý nerez, šedý nerez, černá

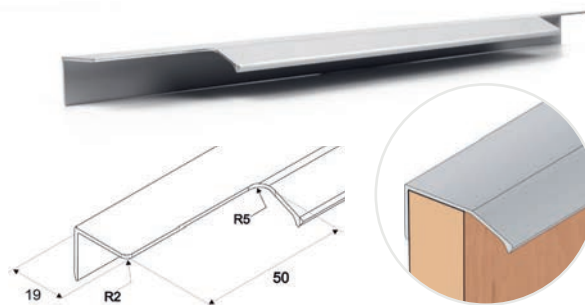
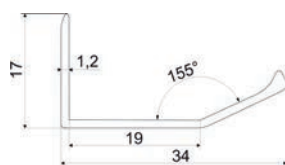
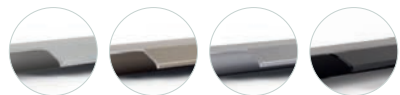
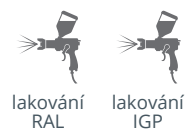

BARVA / DÉLKA (MM)	196	246	296	346	396	446	496	546	596	696	796	896	996	1 196
hliník	793970	793971	793972	793973	793974	793975	793976	793977	793978	793979	793980	793981	793982	793983
světlý nerez	793998	793999	794000	794001	794002	794003	794004	794005	794006	794007	794008	794009	794010	794011
tmavý nerez	794026	794027	794028	794029	794030	794031	794032	794033	794034	794035	794036	794037	794038	794039
šedý nerez	794012	794013	794014	794015	794016	794017	794018	794019	794020	794021	794022	794023	794024	794025
černá	793984	793985	793986	793987	793988	793989	793990	793991	793992	793993	793994	793995	793996	793997

PROFILOVÉ ÚCHYTKY - METRÁŽ

Úchytka lze rovněž zakoupit jako **úchyťový profil v metrži v délce 3 m**. U této varianty není odfrézovaný stromeček k naražení do dvířek. Profil je však zapotřebí zkrátit na potřebnou délku, odfrézovat stromeček profilu k naražení do dvířek a začistit hranu profilu. Tato varianta je časově náročnější na přípravu a finální zpracování.

UK 2

- > délka 3 m
- > materiál hliník
- > barva hliník

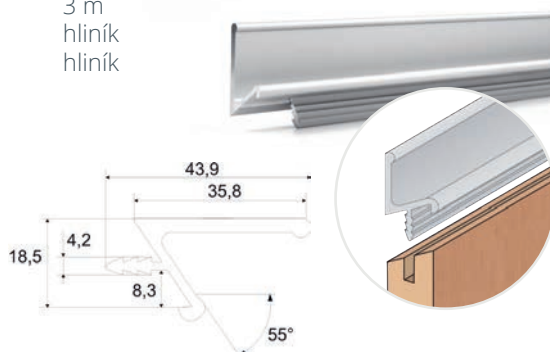

BARVA	KÓD
hliník	794096

UK 4

- > délka 3 m
- > materiál hliník
- > barva hliník

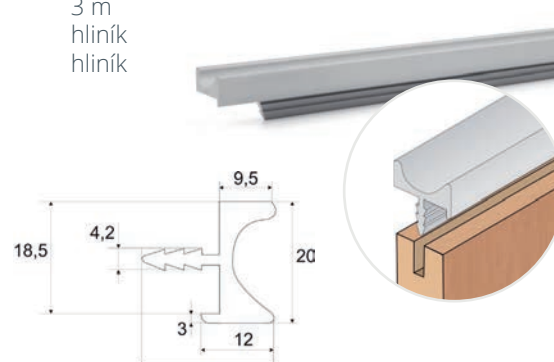

BARVA	KÓD
hliník	794097

UK 5

- > délka 3 m
- > materiál hliník
- > barva hliník, nerez

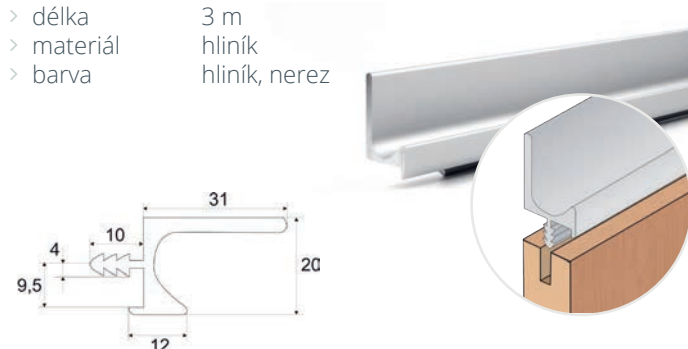

BARVA	KÓD
hliník	541585
nerez	794098

UK 6

- > délka 3 m
- > materiál hliník
- > barva hliník

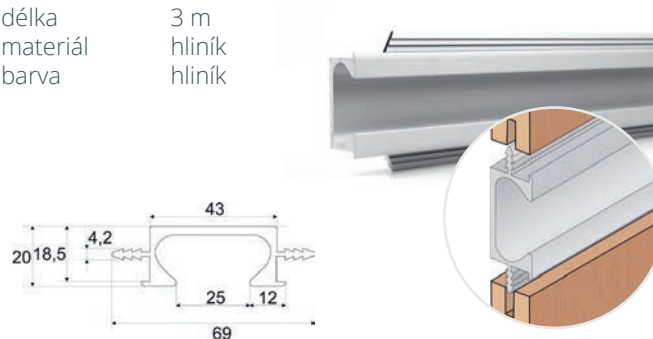

BARVA	KÓD
hliník	794099

7.9 PROFILOVÉ ÚCHYTKY - METRÁŽ

7 ÚCHYTKY, VĚŠÁKY A PROFILY



UK 7

- > délka 3 m
- > materiál hliník
- > barva hliník, světlý nerez, tmavý nerez

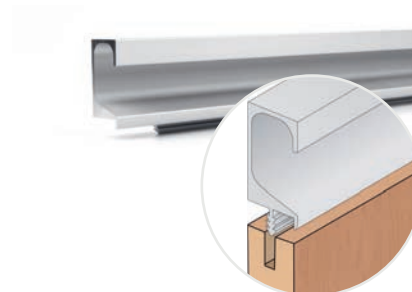
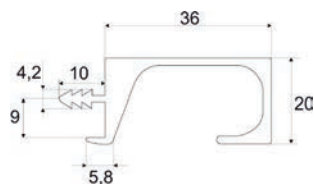

BARVA	KÓD
hliník	569249
nerez	683933

animadomus by Laguna®

LKW 5

- > délka 2,75 m
- > barva hliník

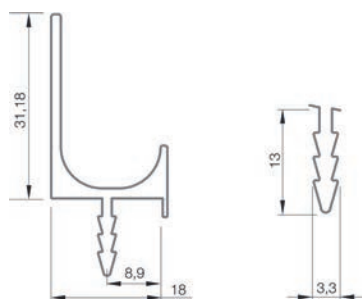

BARVA	KÓD
hliník	418653

LKW 7

- > délka 2,75 m
- > barva hliník

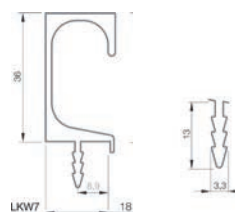

BARVA	KÓD
hliník	425389

7.10 PROFILY PRO BEZÚCHYTKOVÉ OTEVÍRÁNÍ

Profily pro bezúchytkové otevírání jsou velmi oblíbené pro **kuchyňská dvířka s čistou linií**.

Umístění profilu je vždy z vnitřní strany dvířek. Jsou upevňovány do lamina, 22 mm od horního okraje a 38,5 mm od bočního okraje. Otvor pro příchytka – plast 5 mm, kov 8 mm. Rozteč mezi otvory je 32 mm.

UPEVNĚNÍ PROFILŮ:

- > **Plastovou příchytka (vodorovné)** - příchytka se naráží přímo do vyvrtaných otvorů. Profil je přichycen zářezkou ve tvaru „H“.
- > **Kovovou příchytka (vodorovné)** - do vyvrtaných otvorů jsou vloženy plastové hmoždinky (M4), do kterých se příchytka montuje napevno pomocí šroubků. Profil je přichycen zářezkou se šroubkem.
- > **Vrtáním (svislý)** - profil je upevněn zápuštnými vruty do plechu (4,2 x 25 mm) přes lamino, 20 mm od hrany.



MONTÁŽNÍ NÁVOD
profil J a C



FRÉZOVÁNÍ DO KORPUSU
profil J a C



Profil „C“ a „J“ vertikální

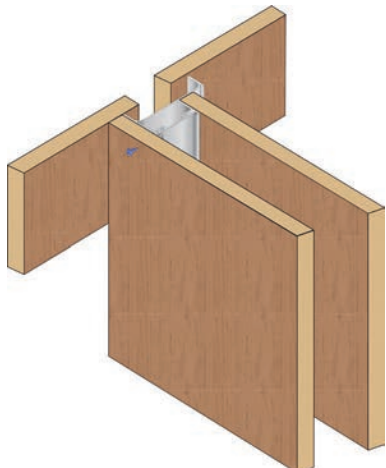

Profil „C“ a „J“ vertikální hranový

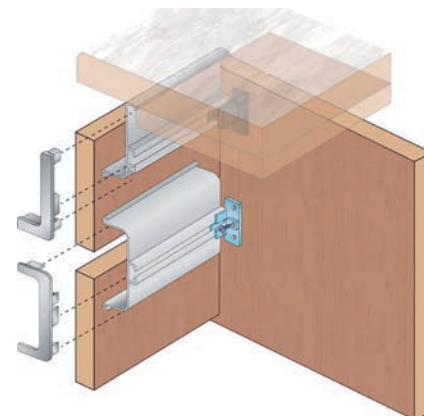
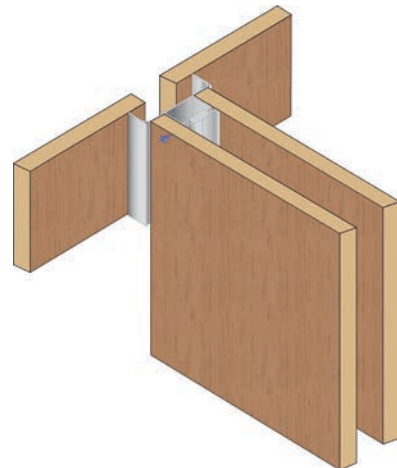

Úchytkový profil „C“

- > vodorovný profil pod pracovní desku
- > tvar profilu C
- > délka 3 m
- > materiál hliník
- > pov. úprava elox (hliník, nerez šedý), komaxit (černá)
- > barva hliník, nerez šedý nebo černá

Úchytkový profil „J“

- > vodorovný profil pod pracovní desku
- > tvar profilu J
- > délka 3 m
- > materiál hliník
- > pov. úprava elox (hliník, nerez šedý), komaxit (černá)
- > barva hliník, nerez šedý nebo černá

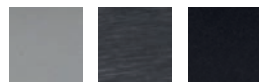

BARVA	KÓD
hliník	789395
nerez šedý	789396
černá	801195

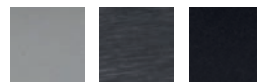

BARVA	KÓD
hliník	789403
nerez šedý	789404
černá	801199



7.10 PROFILY PRO BEZÚCHYTKOVÉ OTEVÍRÁNÍ

7 ÚCHYTKY, VĚŠÁKY A PROFILY



Úchytový profil svislý hranový

- > svislý profil pro montáž na hranu (profil slouží rovněž jako ukončovací profil)
- > délka 3 m
- > materiál hliník
- > pov. úprava elox (hliník, nerez šedý), komaxit (černá)
- > barva hliník, nerez šedý nebo černá



BARVA	KÓD
hliník	789408
nerez šedý	789410
černá	801203



Úchytový profil svislý

- > svislý profil
- > délka 3 m
- > materiál hliník
- > pov. úprava elox (hliník, nerez šedý), komaxit (černá)
- > barva hliník, nerez šedý nebo černá

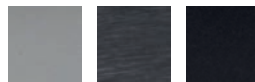

BARVA	KÓD
hliník	789411
nerez šedý	789412
černá	801204



DOPORUČENÉ PŘÍSLUŠENSTVÍ

Vnější roh

- > vnější roh pro úchytové profily „C“ nebo „J“
- > materiál hliník
- > pov. úprava elox (hliník), komaxit (černá)
- > barva hliník nebo černá



PRO PROFIL	BARVA	KÓD
„C“	elox	789400
	černá	801196
„J“	elox	789406
	černá	801200

Vnitřní roh

- > vnitřní roh pro úchytové profily „C“ nebo „J“
- > materiál hliník
- > pov. úprava elox (hliník), komaxit (černá)
- > barva hliník nebo černá



PRO PROFIL	BARVA	KÓD
„C“	elox	789401
	černá	801197
„J“	elox	789407
	černá	801201

Záslepka

- > záslepka pro úchytové profily „C“ nebo „J“
- > materiál hliník
- > pov. úprava elox (hliník), komaxit (černá)
- > barva hliník nebo černá

PRO PROFIL	BARVA	KÓD
„C“	elox	789402
	černá	801198
„J“	elox	789409
	černá	801202



Kovový úchyt profilu

- > kovový příchyt (vodorovný) pro úchytové profily „C“ nebo „J“
- > materiál ocel

PRODUKT	KÓD
úchyt profilu	789398



Plastový úchyt profilu

- > plastový příchyt (vodorovný) pro úchytové profily „C“ nebo „J“
- > materiál plast

PRODUKT	KÓD
úchyt profilu	789399



Spojovací úhelník

- > spojovací úhelník pro úchytový profil „C“ a „J“
- > materiál ocel

PRODUKT	KÓD
spojovací úhelník	789397

