

LOFT IDEA REGULOWANY Z SAMODOMYKACZEM

MOCOWANIE DO ŚCIANY
FASTENING FOR WALL

100
kg



18-35 mm

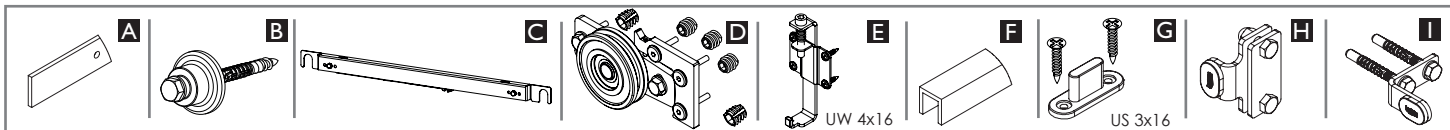

18-35 mm PLYTA BOARD	Liczba skrzydeł / Quantity of doors	$n = l$
	Wysokość płyty hP [mm] / Board height hP [mm]	$hP = H + l38$
	Szerokość płyty bP [mm] / Board width bP [mm]	$bP = S + 80$

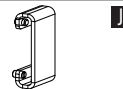

Opcja łączenie torów
Option to connect tracks

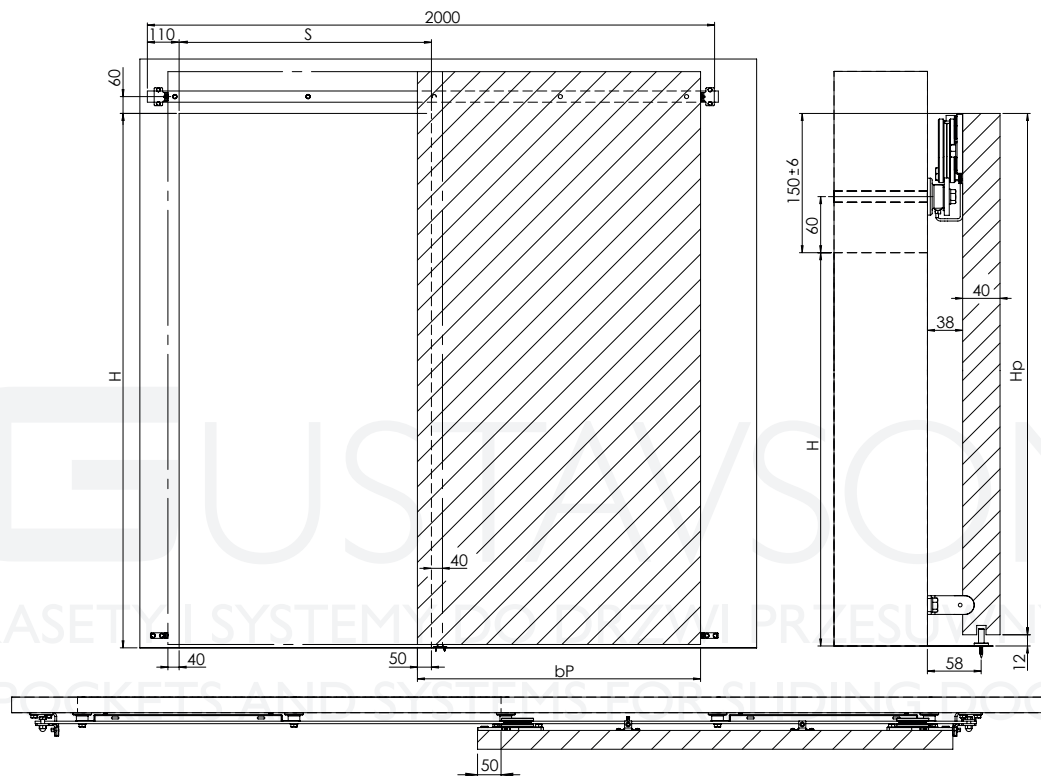

A, B, C

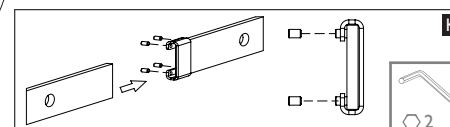
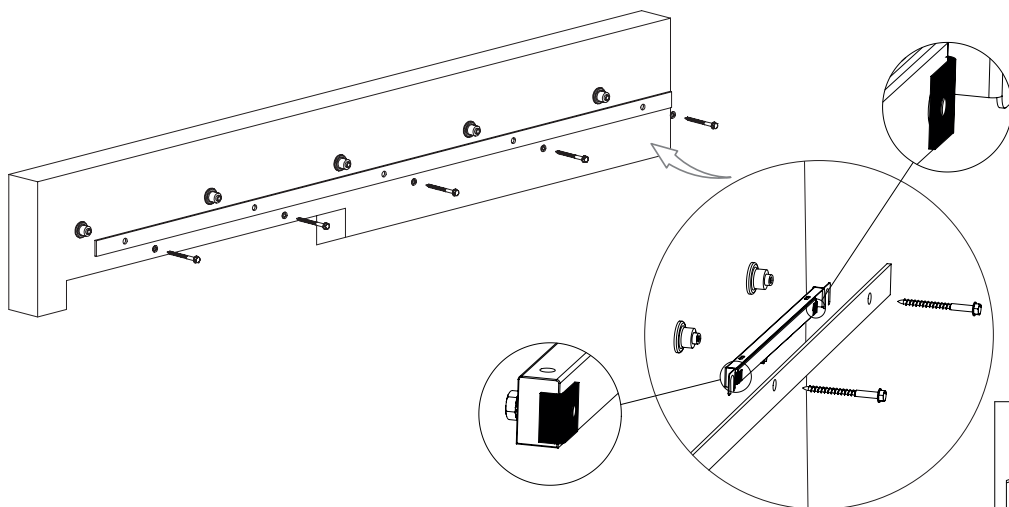
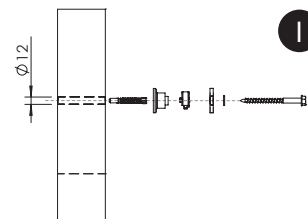
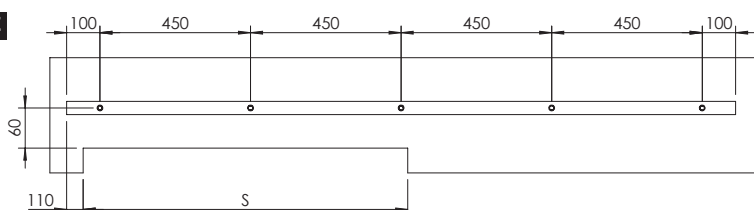



D, E, F

