

RAMA

na kolejnici GAMA
lower track GAMA

50
kg



Gama

16 mm
DESKA | BOARD
18 mm

4 mm
SKLO | GLASS

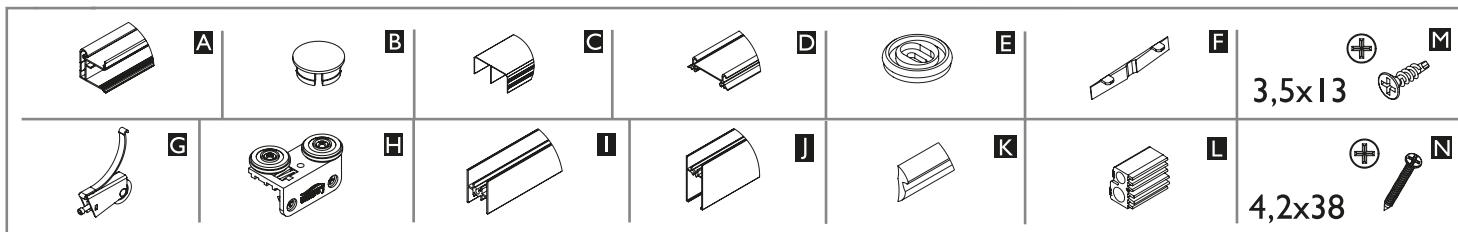
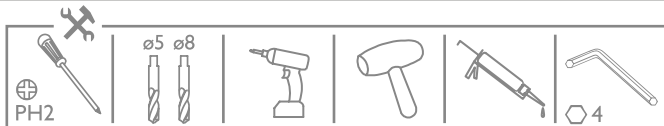

18 mm	Počet křídel n / Quantity of doors n	n = 2	n = 3	n = 4	n = 5	n = 6	n = 7	n = 8
		Výška desky hP [mm] / Board height hP [mm]	hP = H-128					
Šířka desky bP [mm] / Board width bP [mm]		$bP = (S-12)/2$	$bP = (S-2)/3$	$bP = (S+9)/4$	$bP = (S+20)/5$	$bP = (S+31)/6$	$bP = (S+41)/7$	$bP = (S+52)/8$
Délka spodního, horního rámu a spojky R [mm] Upper, lower rail and connector length R [mm]		R = bP-29						
Délka profilu LR [mm] / Handle length LR [mm]		LR = H-47						
	Výška desky hP [mm] / Board height hP [mm]	hP = H-128						
	Šířka desky bP [mm] / Board width bP [mm]	$bP = (S-12)/2$	$bP = (S-2)/3$	$bP = (S+9)/4$	$bP = (S+20)/5$	$bP = (S+31)/6$	$bP = (S+41)/7$	$bP = (S+52)/8$
	Délka spodního, horního rámu a spojky R [mm] Upper, lower rail and connector length R [mm]	R = bP-29						
	Délka profilu LR [mm] / Handle length LR [mm]	LR = H-47						
	Výška zrcadla/skla hL [mm] / Mirror height hL [mm]	hL = H-119						
	Šířka zrcadla/skla bL [mm] / Mirror width bL [mm]	$bL = (S+5)/2$	$bL = (S+25)/3$	$bL = (S+45)/4$	$bL = (S+65)/5$	$bL = (S+85)/6$	$bL = (S+104)/7$	$bL = (S+124)/8$
	Délka dolního, horního rámu a spojky R [mm] Upper, lower rail and connector length R [mm]	R = bL-38						
	Délka profilu LR [mm] / Handle length LR [mm]	LR = H-47						

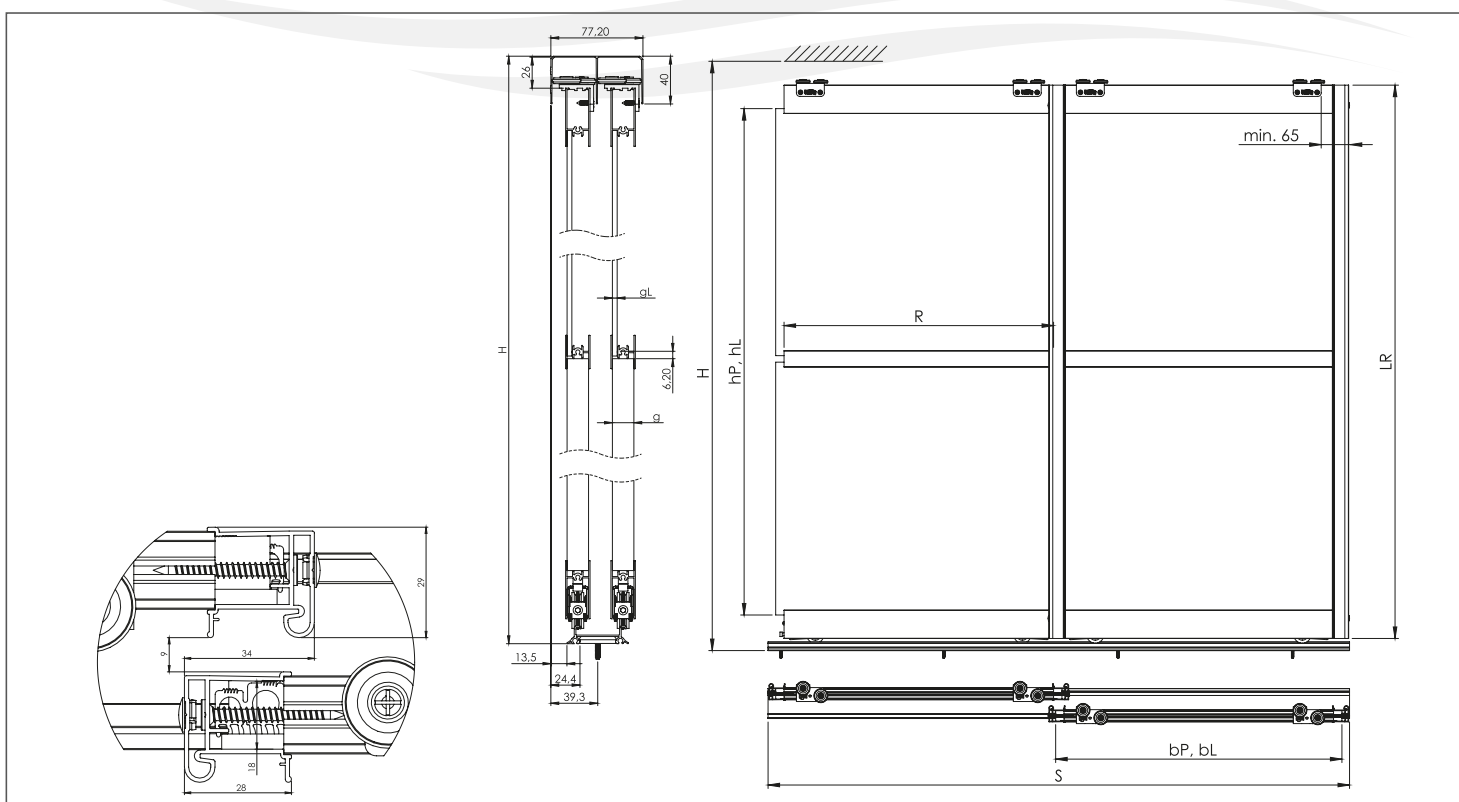

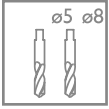

A, B, G, J, N

1

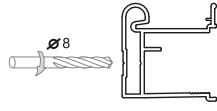
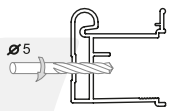
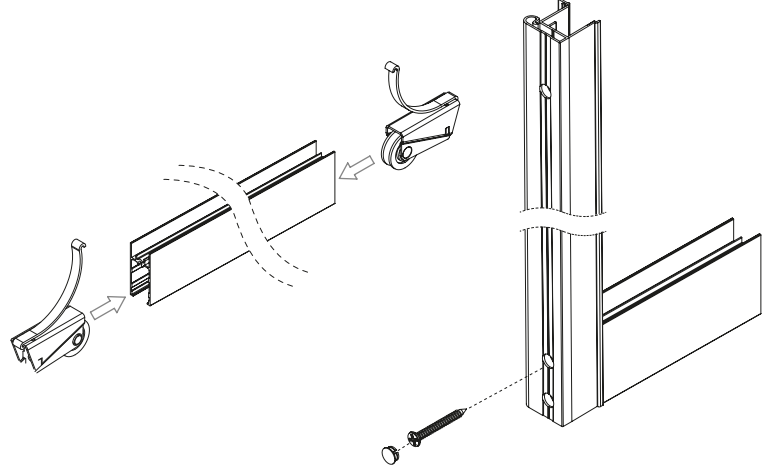
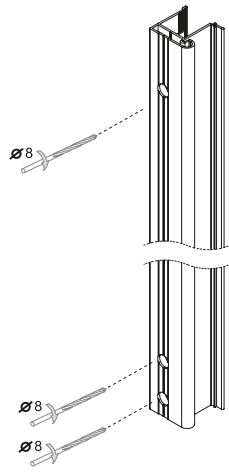
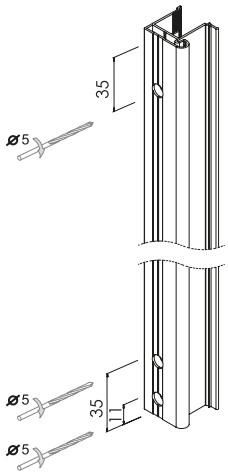

2.1

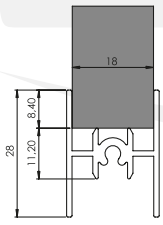

18 mm

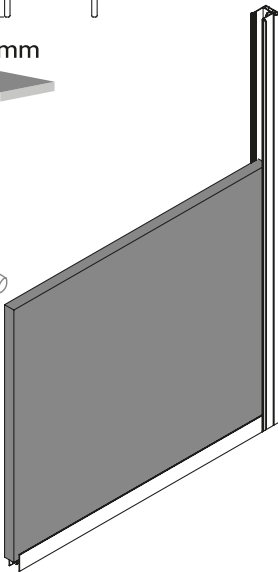

2.2

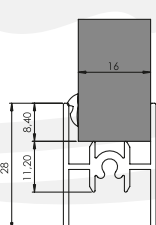

16 mm

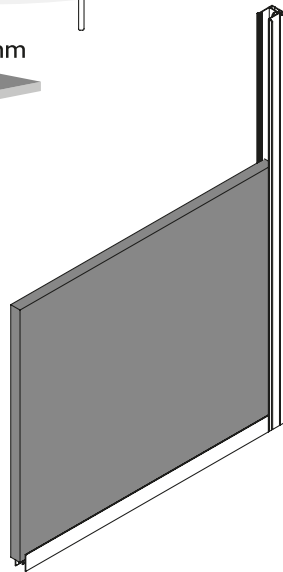

2.3

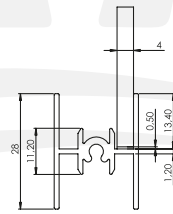

4 mm

