

# RAMA WIDE

na torze GAMA z okuciem SLIM

lower track GAMA with hardware SLIM

50 kg

Gama  
Gama 2

PLYTA | BOARD 18 mm

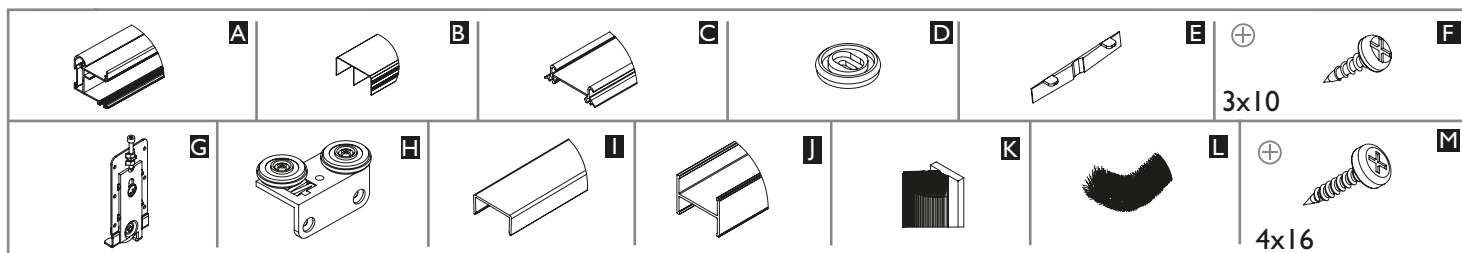
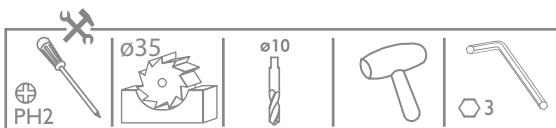

	Liczba skrzydeł n / Quantity of doors n	n = 2	n = 3	n = 4	n = 5	n = 6	n = 7	n = 8	
	Wysokość płyty hP [mm] / Board height hP [mm]	hP = H-49							
	Szerokość płyty bP [mm] / Board width bP [mm]	$bP = (S-21)/2$	$bP = (S-15)/3$	$bP = (S-8)/4$	$bP = (S-2)/5$	$bP = (S+4)/6$	$bP = (S+11)/7$	$bP = (S+17)/8$	
	Długość ramiaka dolnego, górnego oraz łącznika R [mm] Upper, lower rail and connector lenght R [mm]	R = bP-29							
	Długość rączki LR [mm] / Handle lenght LR [mm]	LR = H-47							

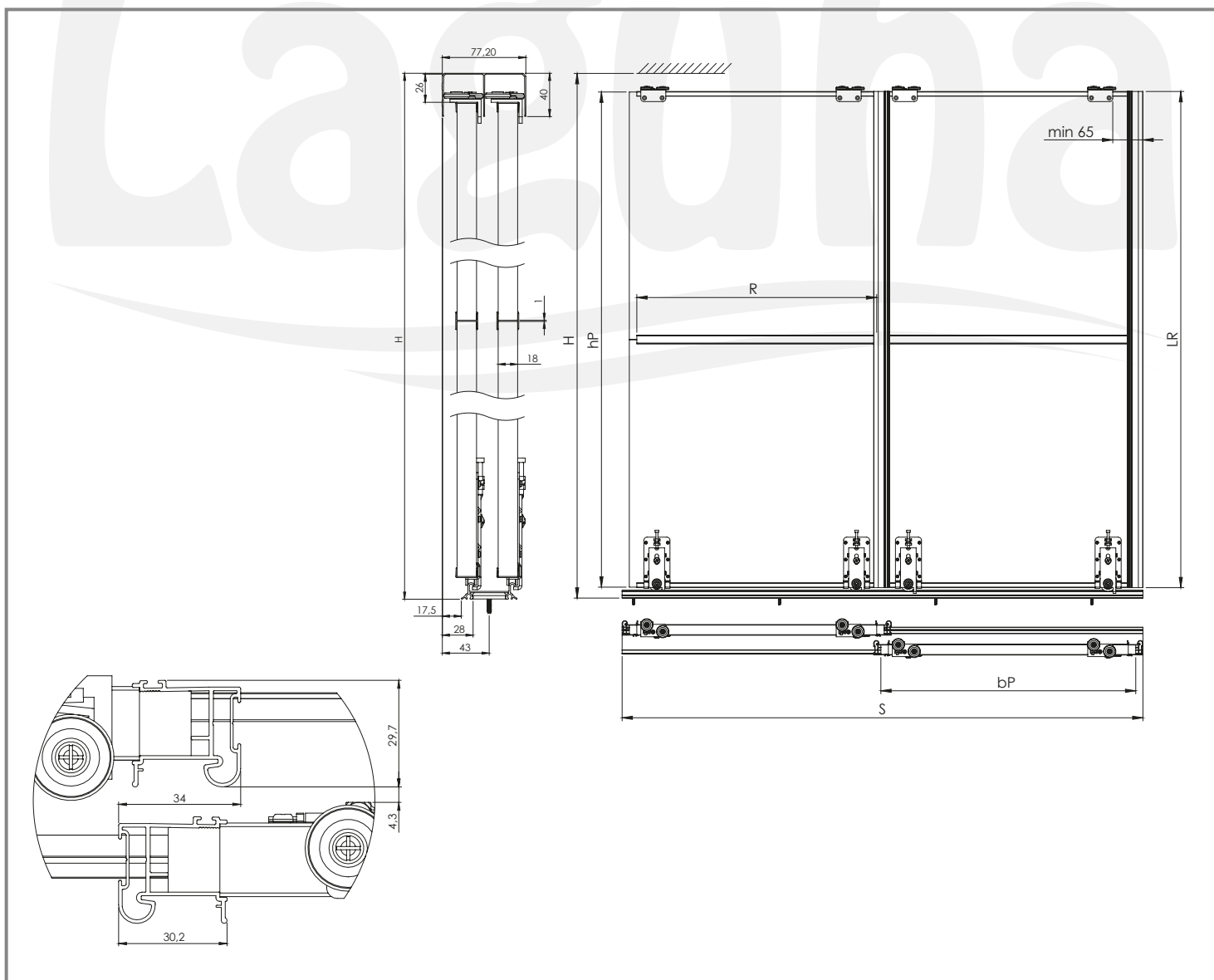

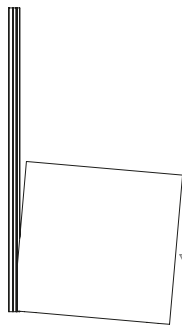
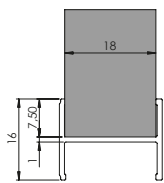
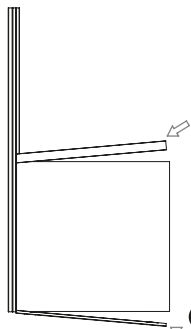
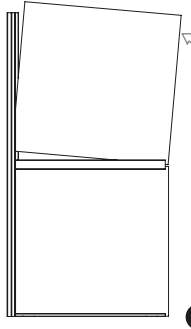
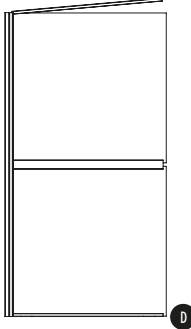
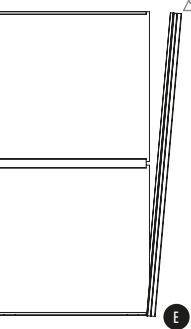
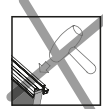
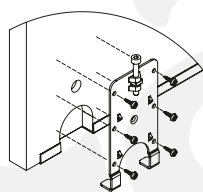
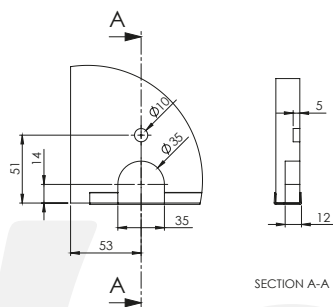
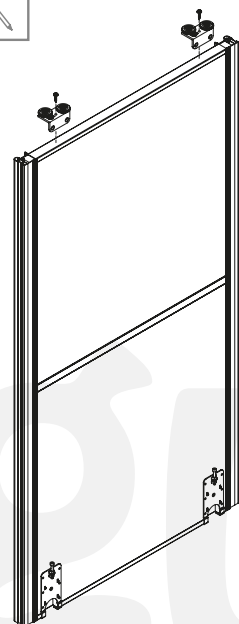
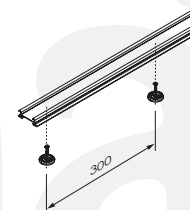
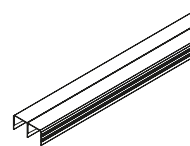
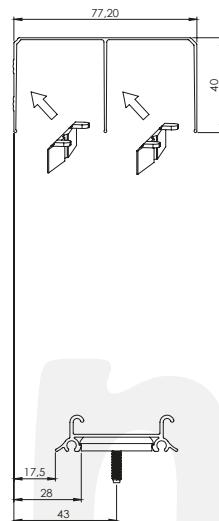
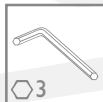
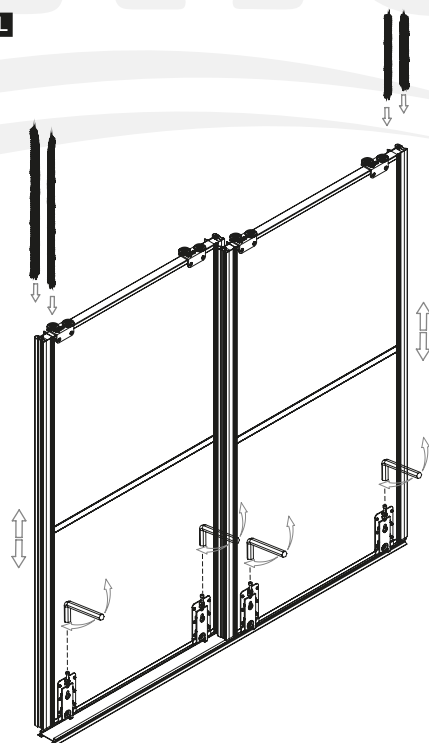
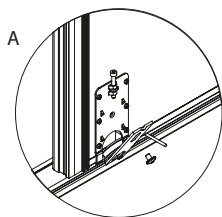
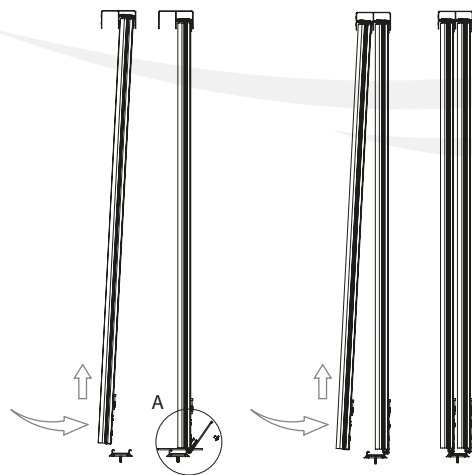
**A, I, J****A****B****C****D****E****!****G, F****2****H, M****3****B, C, D, E****4****5****K, L****6**

Zaleca się postępowanie zgodnie z niniejszą instrukcją przy użyciu odpowiednich narzędzi, zgodnych ze wskazaniami. W przypadku elementów, których powierzchnia może być ostra należy stosować środki ochrony indywidualnej oraz zabezpieczenie obszaru pracy. Firma Laguna Fabryka Okuć Sp. z o.o. Sp. k. uchyla się od odpowiedzialności za działania wynikające z postępowania niezgodnego z niniejszą instrukcją.

It is recommended that you follow these instructions using the appropriate tools as indicated. In the case of elements whose surface can be sharp, use personal protective equipment and work area protection. The company Laguna Hardware Factory Limited Liability Limited Partnership refrains from liability for actions resulting from conduct incompatible with this instruction.